



MBA

2022.3

Sintered Bronze

Plain Bushes - Flanged Bushes - Sheet - Rod - Tube and more



TYPE	PAGES
Bushes - Flanged	3-20
Bushes - Plain	20-73
Bushes - Spherical OD	73
Rod	73-74
Sheet	75
Tube	75-78
Washers	78-80

Copy the part number from this catalogue into the search box on any web page for more information, pricing and availability.

Prefixes and Suffixes - For Bushes

B F 0095 - 0127 - 0191 - BS 16 16 LT

1 2 3 4 5 6 7 8 9

1 Bush Designation:

B: Bush

2 Configuration:

F: Flanged

P: Plain

SP: Spherical OD (not listed in catalogue)

3 Nominal Inside Dia.

One decimal place indication of nominal inside diameter in mm - eg 0095 = 9.53 ID
(refer size listing and tolerances for accuracy)

4 Nominal Outside Dia.:

One decimal place indication of nominal outside diameter in mm - eg 0127 = 12.70 OD
(refer size listing and tolerances for accuracy)

5 Nominal Length:

One decimal place indication of nominal length in mm - eg 0191 = 19.05 Long
(refer size listing and tolerances for accuracy)

6 Material:

BS: Sintered Bronze SAE841

7 Flange Diameter Indicator:

Indicator of approximate flange diameter to zero decimals. eg, 16 = between 15.5 and 16.5mm.

8 Flange Thickness Indicator:

Indicator of approximate flange thickness to one decimal. eg, 16 = between 1.55 and 1.65mm.

9 Tolerance Indicator:

The following codes represent the tolerance range of the I (position 1) and the OD (position 2).

Blank: ID and OD tolerances within standard range

L: Tolerance is lower than standard

H: Tolerance is higher than standard

T: Tolerance is within standard range (Not used in part number if both OD and ID are within standard range)

U: Diameter is undersized from nominal listed diameter

Standard diametrical tolerances are listed in NOTES towards the back of this catalogue.

Diagrams and Pictures

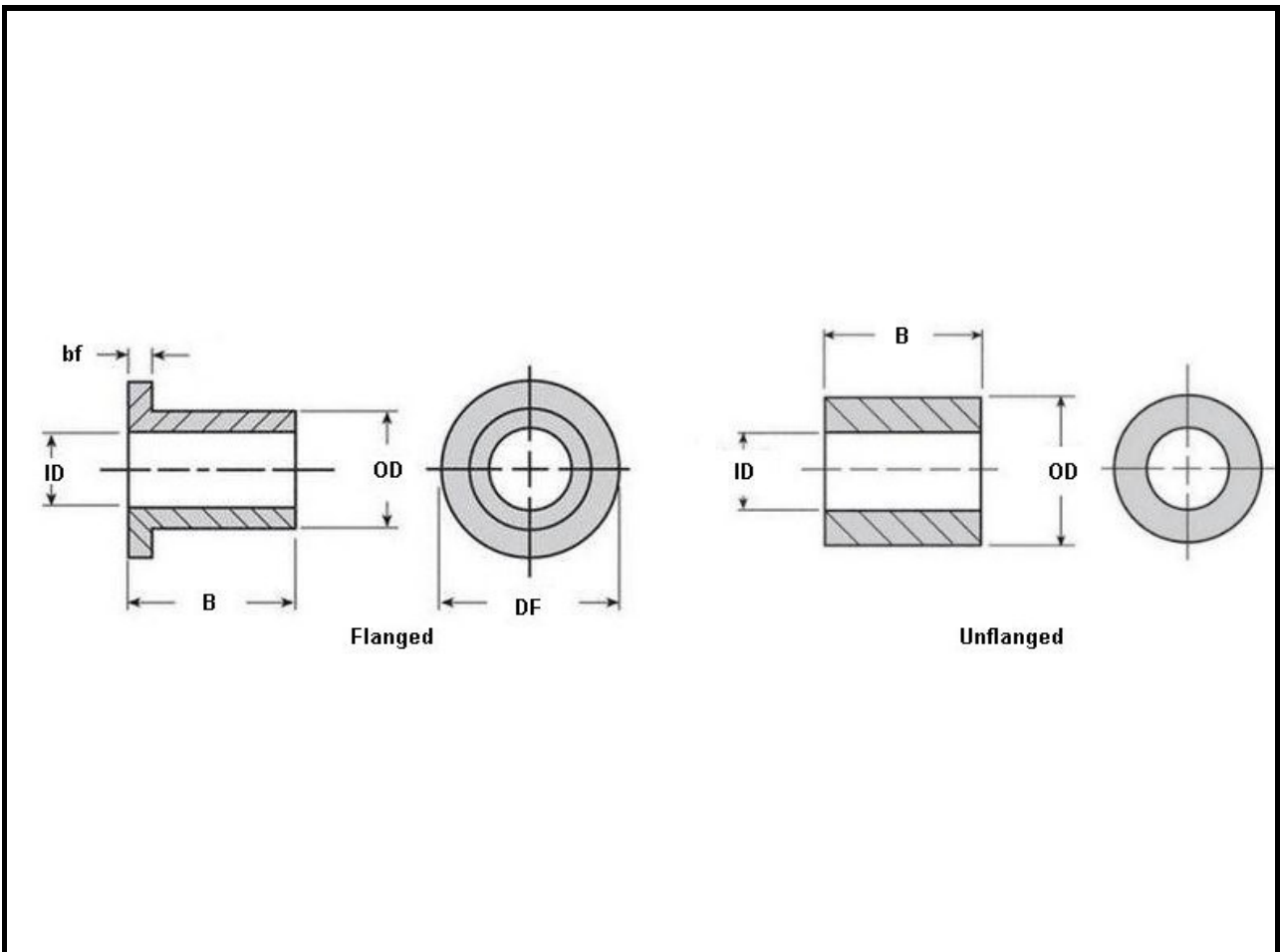

Bushes - Flanged

Nominal ID (d) mm (inches)	Nominal OD (D) mm	Length (S) mm	Flange OD (D1) mm	Flange Thickness (S1) mm	Part Number
1.191 (0.047") +0.000/+0.010 (mm)	3.969 -0.011/+0.001	1.588 +0/-0.127	5.16	0.33	BF0012-0040-0016-BSLU
1.191 (0.047") +0.000/+0.010 (mm)	3.969 -0.011/+0.001	2.380 +0/-0.127	5.16	0.79	BF0012-0040-0024-BSLU
1.191 (0.047") +0.000/+0.010 (mm)	4.763 -0.010/+0.003	1.984 +0/-0.127	5.94	0.58	BF0012-0048-0020-BSLU
1.191 (0.047") +0.000/+0.010 (mm)	4.763 -0.010/+0.003	2.779 +0/-0.127	5.94	0.79	BF0012-0048-0028-BSLU
1.588 (0.063") +0.000/+0.010 (mm)	4.763 -0.010/+0.003	2.779 +0/-0.127	5.94	0.79	BF0016-0048-0028-BSLU
1.588 (0.063") +0.000/+0.010 (mm)	6.350 -0.010/+0.003	2.380 +0/-0.127	7.52	0.79	BF0016-0064-0024-BSLU
1.984 (0.078") +0.000/+0.010 (mm)	6.350 -0.010/+0.003	2.380 +0/-0.127	7.52	0.58	BF0019-0064-0024-BSLU
1.984 (0.078") +0.000/+0.010 (mm)	6.350 -0.010/+0.003	3.571 +0/-0.127	7.52	0.79	BF0019-0064-0036-BSLU
2.000 (0.079") +0.014/+0.024 (mm)	4.000 +0.015/+0.027	4.000 +0/-0.200	6.00	1.50	BF0020-0040-0040-BSLL
2.000 (0.079") +0.014/+0.024 (mm)	5.000 +0.019/+0.031	3.000 +/-0.127	8.00	1.50	BF0020-0050-0030-BSLL
2.381 (0.094") +0.000/+0.010 (mm)	4.763 -0.010/+0.003	1.588 +0/-0.127	5.94	0.46	BF0024-0048-0016-BSLU
2.381 (0.094") +0.000/+0.010 (mm)	4.763 -0.010/+0.003	2.380 +0/-0.127	5.94	0.79	BF0024-0048-0024-BSLU
2.381 (0.094") +0.000/+0.010 (mm)	7.938 -0.010/+0.003	2.779 +0/-0.127	9.12	0.58	BF0024-0079-0028-BS0906LU
2.381 (0.094") +0.000/+0.010 (mm)	7.938 -0.010/+0.003	2.779 +0/-0.127	9.12	0.79	BF0024-0079-0028-BSLU
2.381 (0.094") +0.000/+0.010 (mm)	7.938 -0.010/+0.003	3.571 +0/-0.127	9.12	0.79	BF0024-0079-0036-BSLU
2.500 (0.098") +0.014/+0.024 (mm)	6.000 +0.021/+0.046	3.000 +/-0.127	9.00	1.50	BF0025-0060-0030-BSLT
3.000 (0.118") +0.014/+0.024 (mm)	5.000 +0.019/+0.040	4.000 +0/-0.200	8.00	1.50	BF0030-0050-0040-BSLL
3.000 (0.118") +0.000/+0.010 (mm)	6.000 -0.008/+0.000	2.500 +0/-0.170	8.00	0.50	BF0030-0060-0025-BSLU
3.000 (0.118") +0.000/+0.020 (mm)	6.000 +0.019/+0.040	4.000 +/-0.127	9.00	1.50	BF0030-0060-0040-BS
3.000 (0.118") +0.000/+0.020 (mm)	6.000 +0.019/+0.040	6.000 +/-0.120	9.00	1.50	BF0030-0060-0060-BS
3.000 (0.118") +0.000/+0.020 (mm)	6.000 +0.019/+0.040	10.000 +/-0.120	9.00	1.50	BF0030-0060-0100-BS
3.000 (0.118") +0.000/+0.010 (mm)	8.000 -0.008/+0.000	3.000 +0/-0.170	10.00	0.50	BF0030-0080-0030-BSLU
3.000 (0.118") +0.000/+0.010 (mm)	10.000 -0.009/+0.000	4.000 +0/-0.170	12.00	1.00	BF0030-0100-0040-BSLU
3.175 (0.125") +0.000/+0.025 (mm)	4.763 +0.038/+0.063	5.791 +0/-0.305	6.35	0.89	BF0032-0048-0058-BSLH
3.175 (0.125") -0.013/+0.013 (mm)	5.556 +0.045/+0.070	3.100 -0.178/+0	8.64	1.27	BF0032-0056-0031-BSUH
3.175 (0.125") +0.025/+0.051 (mm)	5.556 +0.045/+0.070	3.759 -0.178/+0	8.76	1.55	BF0032-0056-0038-BSTH
3.175 (0.125") +0.000/+0.010 (mm)	6.350 -0.010/+0.003	2.380 +0/-0.127	7.52	0.58	BF0032-0064-0024-BSLU
3.175 (0.125") +0.000/+0.010 (mm)	6.350 -0.010/+0.003	2.779 +0/-0.127	7.52	0.79	BF0032-0064-0028-BSLU
3.175 (0.125") +0.025/+0.051 (mm)	6.350 +0.025/+0.051	3.175 +/-0.127	9.14	1.19	BF0032-0064-0032-BS
3.175 (0.125") +0.000/+0.025 (mm)	6.350 +0.025/+0.051	6.350	7.930	1.59	BF0032-0064-0064-BS0816LT
3.175 (0.125") +0.025/+0.051 (mm)	6.350 +0.025/+0.051	6.350 +/-0.127	9.14	1.19	BF0032-0064-0064-BS0912
3.175 (0.125") +0.000/+0.025 (mm)	6.350 +0.025/+0.051	9.525	7.930	1.59	BF0032-0064-0095-BS0816LT
3.175 (0.125") +0.025/+0.051 (mm)	6.350 +0.025/+0.051	9.525 +/-0.127	9.14	1.19	BF0032-0064-0095-BS0912
3.175 (0.125") +0.000/+0.010 (mm)	7.938 -0.010/+0.003	2.779 +0/-0.127	9.12	0.58	BF0032-0079-0028-BSLU

 Stocked or Short Delivery

 Usually Available Short Delivery

 Long delivery or not in current production

* Large Minimum Quantities

** Available only while stock last:

Bushes - Flanged

Nominal ID (d) mm (inches)	Nominal OD (D) mm	Length (S) mm	Flange OD (D1) mm	Flange Thickness (S1) mm	Part Number
3.175 (0.125") +0.000/+0.010 (mm)	7.938 -0.010/+0.003	3.571 +0/-0.127	9.12	0.79	BF0032-0079-0036-BSLU
3.175 (0.125") +0.025/+0.051 (mm)	7.938 +0.038/+0.064	6.350	9.530	1.19	BF0032-0079-0064-BSTH
3.175 (0.125") +0.025/+0.051 (mm)	7.938 +0.038/+0.064	9.525	9.530	1.19	BF0032-0079-0095-BSTH
3.175 (0.125") +0.000/+0.010 (mm)	9.525 -0.010/+0.003	2.779 +0/-0.127	10.72	0.58	BF0032-0095-0028-BSLU
3.175 (0.125") +0.000/+0.010 (mm)	9.525 -0.010/+0.003	3.571 +0/-0.127	10.72	0.79	BF0032-0095-0036-BSLU
3.969 (0.156") +0.000/+0.010 (mm)	7.938 -0.010/+0.003	2.779 +0/-0.127	9.12	0.58	BF0039-0079-0028-BSLU
3.969 (0.156") +0.000/+0.010 (mm)	7.938 -0.010/+0.003	3.175 +0/-0.127	9.12	0.91	BF0039-0079-0032-BSLU
4.000 (0.157") +0.000/+0.020 (mm)	7.000 +0.019/+0.040	6.000 +/-0.120	12.00	2.00	BF0040-0070-0060-BS
4.000 (0.157") +0.000/+0.020 (mm)	7.000 +0.019/+0.040	10.000 +/-0.120	12.00	2.00	BF0040-0070-0100-BS
4.000 (0.157") +0.000/+0.012 (mm)	8.000 -0.008/+0.000	4.000 +0/-0.170	10.00	1.00	BF0040-0080-0040-BS1010LU
4.000 (0.157") +0.000/+0.020 (mm)	8.000 +0.019/+0.040	4.000 +/-0.127	12.00	2.00	BF0040-0080-0040-BS
4.000 (0.157") +0.020/+0.032 (mm)	8.000 +0.019/+0.034	6.000 +0/-0.200	10.00	1.50	BF0040-0080-0060-BS1015TL
4.000 (0.157") +0.000/+0.020 (mm)	8.000 +0.019/+0.040	6.000 +/-0.127	12.00	2.00	BF0040-0080-0060-BS1220
4.000 (0.157") +0.000/+0.020 (mm)	8.000 +0.019/+0.040	8.000 +/-0.127	12.00	2.00	BF0040-0080-0080-BS
4.000 (0.157") +0.000/+0.020 (mm)	8.000 +0.019/+0.040	12.000 +/-0.127	12.00	2.00	BF0040-0080-0120-BSLT
4.763 (0.188") +0.012/+0.038 (mm)	6.350 +0.051/+0.076	8.865 +0/-0.127	7.87	0.86	BF0048-0064-0089-BSLH
4.763 (0.188") +0.000/+0.025 (mm)	7.144 +0.045/+0.070	5.537 +0/-0.152	96.14	1.45	BF0048-0071-0055-BSLH
4.763 (0.188") +0.012/+0.038 (mm)	7.144 +0.051/+0.076	7.137 +/-0.127	9.53	3.07	BF0048-0071-0071-BSLH
4.763 (0.188") +0.012/+0.038 (mm)	7.938 +0.025/+0.051	3.175 +/-0.191	9.53	1.19	BF0048-0079-0032-BSLT
4.763 (0.188") +0.000/+0.025 (mm)	7.938 +0.051/+0.076	3.416 -0.178/+0	11.11	1.57	BF0048-0079-0034-BSLH
4.763 (0.188") +0.025/+0.051 (mm)	7.938 +0.012/+0.038	4.763 +/-0.127	11.11	1.59	BF0048-0079-0048-BS1116TL
4.763 (0.188") +0.012/+0.038 (mm)	7.938 +0.051/+0.076	6.096 +0/-0.152	9.53	2.21	BF0048-0079-0061-BSLH
4.763 (0.188") +0.025/+0.051 (mm)	7.938 +0.012/+0.038	6.350 +/-0.127	11.11	1.59	BF0048-0079-0064-BS1116TL
4.763 (0.188") +0.025/+0.051 (mm)	7.938 +0.025/+0.051	6.350 +/-0.127	9.40	1.19	BF0048-0079-0064-BS0912
4.763 (0.188") +0.012/+0.038 (mm)	7.938 +0.025/+0.051	6.350 +/-0.191	9.53	1.19	BF0048-0079-0064-BS1012LT
4.763 (0.188") +0.025/+0.051 (mm)	7.938 +0.023/+0.038	6.350 +/-0.127	9.53	1.58	BF0048-0079-0064-BS1016
4.763 (0.188") -0.038/-0.013 (mm)	7.938 -0.013/+0.012	6.350 +/-0.127	9.53	1.59	BF0048-0079-0064-BS1016UU
4.763 (0.188") +0.025/+0.051 (mm)	7.938 +0.012/+0.038	7.938 +/-0.127	11.11	1.59	BF0048-0079-0079-BS1116TL
4.763 (0.188") +0.025/+0.051 (mm)	7.938 +0.012/+0.038	9.525 +/-0.127	11.11	1.59	BF0048-0079-0095-BS1116TL
4.763 (0.188") +0.025/+0.051 (mm)	7.938 +0.025/+0.051	9.525 +/-0.127	9.40	1.19	BF0048-0079-0095-BS0912
4.763 (0.188") +0.012/+0.038 (mm)	7.938 +0.025/+0.051	9.525 +/-0.127	9.53	1.19	BF0048-0079-0095-BS1012LT
4.763 (0.188") +0.025/+0.051 (mm)	7.938 +0.023/+0.038	9.525 +/-0.127	9.53	1.58	* BF0048-0079-0095-BS1016
4.763 (0.188") -0.038/-0.013 (mm)	7.938 -0.013/+0.012	9.525 +/-0.127	9.53	1.59	BF0048-0079-0095-BS1016UU
4.763 (0.188") +0.025/+0.051 (mm)	7.938 +0.013/+0.038	12.700	11.110	1.59	BF0048-0079-0127-BS1116TL

Stocked or Short Delivery

Usually Available Short Delivery

Long delivery or not in current production

* Large Minimum Quantities

** Available only while stock last:

Bushes - Flanged

Nominal ID (d) mm (inches)	Nominal OD (D) mm	Length (S) mm	Flange OD (D1) mm	Flange Thickness (S1) mm	Part Number
4.763 (0.188") +0.025/+0.051 (mm)	7.938 +0.025/+0.051	12.700 +/-0.127	9.40	1.19	BF0048-0079-0127-BS0912
4.763 (0.188") +0.025/+0.051 (mm)	7.938 +0.023/+0.038	12.700 +/-0.127	9.53	1.58	BF0048-0079-0127-BS1016
4.763 (0.188") +0.025/+0.051 (mm)	7.938 +0.025/+0.051	15.875 +/-0.127	9.40	1.19	BF0048-0079-0159-BS
4.763 (0.188") +0.000/+0.010 (mm)	9.525 -0.010/+0.003	2.779 +0/-0.127	10.72	0.58	BF0048-0095-0028-BSLU
4.763 (0.188") +0.000/+0.010 (mm)	9.525 -0.010/+0.003	3.175 +0/-0.127	10.72	0.58	BF0048-0095-0032-BS1106LU
4.763 (0.188") +0.000/+0.010 (mm)	9.525 -0.010/+0.003	3.175 +0/-0.127	10.72	0.79	BF0048-0095-0032-BS1108LU
4.763 (0.188") +0.025/+0.051 (mm)	9.525 +0.012/+0.038	9.525 +/-0.127	11.11	1.59	BF0048-0095-0095-BS1116TL
4.763 (0.188") +0.025/+0.051 (mm)	9.525 +0.012/+0.038	12.700 +/-0.127	11.11	1.59	BF0048-0095-0127-BS1116TL
4.763 (0.188") +0.000/+0.010 (mm)	12.700 -0.010/+0.003	3.967 +0/-0.127	14.35	1.07	BF0048-0127-0040-BSLU
4.763 (0.188") +0.000/+0.010 (mm)	12.700 -0.010/+0.003	4.978 +0/-0.127	14.35	1.07	BF0048-0127-0050-BSLU
5.000 (0.197") +0.000/+0.020 (mm)	8.000 +0.019/+0.040	5.000 +/-0.120	12.00	2.00	BF0050-0080-0050-BS
5.000 (0.197") +0.020/+0.032 (mm)	8.000 +0.019/+0.034	6.000 +0/-0.200	10.00	2.00	BF0050-0080-0060-BSTL
5.000 (0.197") +0.000/+0.020 (mm)	8.000 +0.019/+0.040	6.000 +/-0.120	12.00	2.00	BF0050-0080-0060-BS
5.000 (0.197") +0.020/+0.032 (mm)	9.000 +0.023/+0.038	4.000 +/-0.127	13.00	2.00	BF0050-0090-0040-BS
5.000 (0.197") +0.020/+0.032 (mm)	9.000 +0.023/+0.038	5.000 +/-0.127	13.00	2.00	BF0050-0090-0050-BS
5.000 (0.197") +0.020/+0.032 (mm)	9.000 +0.023/+0.038	8.000 +/-0.127	13.00	2.00	BF0050-0090-0080-BS
5.000 (0.197") +0.000/+0.012 (mm)	10.000 -0.009/+0.000	5.000 +0/-0.170	12.00	1.00	BF0050-0100-0050-BSLU
5.000 (0.197") +0.020/+0.032 (mm)	10.000 +0.019/+0.034	6.000 +0/-0.200	12.00	2.00	BF0050-0100-0060-BSTL
5.000 (0.197") +0.000/+0.012 (mm)	12.000 -0.011/+0.000	4.000 +0/-0.170	14.00	1.00	BF0050-0120-0040-BSLU
5.000 (0.197") +0.000/+0.012 (mm)	13.000 -0.011/+0.000	5.000 +0/-0.170	14.00	1.00	BF0050-0130-0050-BSLU
5.556 (0.219") -0.019/+0.006 (mm)	7.144 +0.006/+0.032	5.258 +0/-0.127	7.87	2.13	BF0056-0071-0053-BSUL
6.000 (0.236") +0.000/+0.020 (mm)	9.000 +0.019/+0.040	5.000 +/-0.120	14.00	1.50	BF0060-0090-0050-BS
6.000 (0.236") +0.000/+0.020 (mm)	9.000 +0.019/+0.040	6.000 +/-0.120	12.00	1.50	BF0060-0090-0060-BS
6.000 (0.236") +0.005/+0.030 (mm)	9.000 +0.019/+0.040	10.000 +0/-0.127	12.00	1.50	BF0060-0090-0100-BSLT
6.000 (0.236") +0.000/+0.020 (mm)	9.000 +0.019/+0.040	10.000 +/-0.120	12.00	1.50	BF0060-0090-0100-BS
6.000 (0.236") +0.000/+0.020 (mm)	9.000 +0.019/+0.040	12.000 +/-0.120	12.00	1.50	BF0060-0090-0120-BS
6.000 (0.236") +0.000/+0.025 (mm)	10.000 +0.025/+0.051	4.000 +/-0.127	14.00	2.00	BF0060-0100-0040-BSLT
6.000 (0.236") +0.000/+0.012 (mm)	10.000 -0.009/+0.000	5.000 +0/-0.170	12.00	1.00	BF0060-0100-0050-BSLU
6.000 (0.236") +0.005/+0.030 (mm)	10.000 +0.019/+0.040	6.000 +0/-0.200	14.00	2.00	BF0060-0100-0060-BSTL
6.000 (0.236") +0.000/+0.020 (mm)	10.000 +0.019/+0.040	10.000 +/-0.127	14.00	2.00	BF0060-0100-0100-BS
6.000 (0.236") +0.000/+0.020 (mm)	10.000 +0.019/+0.040	14.000 +/-0.120	14.00	2.00	BF0060-0100-0140-BS
6.000 (0.236") +0.000/+0.020 (mm)	10.000 +0.019/+0.040	16.000 +/-0.120	14.00	2.00	BF0060-0100-0160-BS
6.000 (0.236") +0.020/+0.032 (mm)	12.000 +0.023/+0.041	6.000 +0/-0.200	14.00	2.00	BF0060-0120-0060-BS
6.000 (0.236") +0.000/+0.012 (mm)	16.000 -0.010/+0.003	5.000 +0/-0.170	18.00	1.00	BF0060-0160-0050-BSLU

 Stocked or Short Delivery

 Usually Available Short Delivery

 Long delivery or not in current production

* Large Minimum Quantities

** Available only while stock last:

Bushes - Flanged

Nominal ID (d) mm (inches)	Nominal OD (D) mm	Length (S) mm	Flange OD (D1) mm	Flange Thickness (S1) mm	Part Number
6.350 (0.250") +0.025/+0.051 (mm)	7.938 +0.063/+0.089	3.962 +/-0.127	11.11	1.65	BF0064-0079-0040-BSTH
6.350 (0.250") +0.025/+0.051 (mm)	7.938 +0.063/+0.089	6.350 +/-0.127	11.11	1.65	BF0064-0079-0064-BSTH
6.350 (0.250") +0.025/+0.051 (mm)	7.938 +0.051/+0.076	12.700 +/-0.127	11.11	1.68	BF0064-0079-0127-BSTH
6.350 (0.250") +0.000/+0.010 (mm)	9.525 -0.010/+0.003	3.175 +0/-0.127	10.72	0.58	BF0064-0095-0032-BS1106LU
6.350 (0.250") +0.000/+0.010 (mm)	9.525 -0.010/+0.003	3.175 +0/-0.127	10.72	0.91	BF0064-0095-0032-BS1109LU
6.350 (0.250") -0.025/+0.000 (mm)	9.525 +0.127/+0.152	4.763 +/-0.127	12.70	1.59	BF0064-0095-0048-BS1316UH
6.350 (0.250") +0.025/+0.051 (mm)	9.525 +0.038/+0.063	6.350 +/-0.127	11.91	1.59	BF0064-0095-0064-BS1216TH
6.350 (0.250") +0.025/+0.051 (mm)	9.525 +0.025/+0.051	6.350 +/-0.191	12.70	1.19	BF0064-0095-0064-BS1312
6.350 (0.250") -0.025/+0.000 (mm)	9.525 +0.127/+0.152	6.350 +/-0.127	12.70	1.59	BF0064-0095-0064-BS1316UH
6.350 (0.250") -0.025/+0.000 (mm)	9.525 +0.127/+0.152	7.938 +/-0.127	12.70	1.59	BF0064-0095-0079-BS1316UH
6.350 (0.250") +0.025/+0.051 (mm)	9.525 +0.038/+0.063	9.525 +/-0.127	11.91	1.19	BF0064-0095-0095-BS1212TH
6.350 (0.250") +0.025/+0.051 (mm)	9.525 +0.038/+0.063	9.525 +/-0.127	11.91	1.59	BF0064-0095-0095-BS1216TH
6.350 (0.250") +0.025/+0.051 (mm)	9.525 +0.025/+0.051	9.525 +/-0.191	12.70	1.19	BF0064-0095-0095-BS1312
6.350 (0.250") +0.025/+0.051 (mm)	9.525 +0.023/+0.038	9.525 +/-0.127	12.70	1.58	BF0064-0095-0095-BS1316
6.350 (0.250") -0.025/+0.000 (mm)	9.525 +0.127/+0.152	9.525 +/-0.127	12.70	1.59	BF0064-0095-0095-BS1316UH
6.350 (0.250") +0.025/+0.051 (mm)	9.525 +0.076/+0.102	10.312 +/-0.127	12.70	2.41	BF0064-0095-0103-BSTH
6.350 (0.250") -0.025/+0.000 (mm)	9.525 +0.127/+0.152	11.113 +/-0.127	12.70	1.59	BF0064-0095-0111-BS1316UH
6.350 (0.250") +0.025/+0.051 (mm)	9.525 +0.038/+0.063	12.700 +/-0.127	11.91	1.59	BF0064-0095-0127-BS1216TH
6.350 (0.250") +0.025/+0.051 (mm)	9.525 +0.025/+0.051	12.700 +/-0.191	12.70	1.19	BF0064-0095-0127-BS1312
6.350 (0.250") +0.025/+0.051 (mm)	9.525 +0.023/+0.038	12.700 +/-0.127	12.70	1.58	BF0064-0095-0127-BS1316
6.350 (0.250") +0.051/+0.076 (mm)	9.525 +0.025/+0.051	12.700 +/-0.127	12.70	1.59	BF0064-0095-0127-BS1316HT
6.350 (0.250") -0.025/+0.000 (mm)	9.525 +0.127/+0.152	12.700 +/-0.127	12.70	1.59	BF0064-0095-0127-BS1316UH
6.350 (0.250") -0.025/+0.000 (mm)	9.525 +0.127/+0.152	14.288 +/-0.127	12.70	1.59	BF0064-0095-0143-BS1316UH
6.350 (0.250") +0.025/+0.051 (mm)	9.525 +0.076/+0.102	14.681 +0/-0.127	12.70	2.41	BF0064-0095-0147-BSTH
6.350 (0.250") +0.025/+0.051 (mm)	9.525 +0.025/+0.051	15.875 +/-0.191	12.70	1.19	BF0064-0095-0159-BS
6.350 (0.250") -0.025/+0.000 (mm)	9.525 +0.127/+0.152	17.463 +/-0.127	12.70	1.59	BF0064-0095-0175-BS1316UH
6.350 (0.250") +0.025/+0.051 (mm)	9.525 +0.025/+0.051	19.050 +/-0.191	12.70	1.19	BF0064-0095-0191-BS1312
6.350 (0.250") +0.025/+0.051 (mm)	9.525 +0.023/+0.038	19.050 +/-0.127	12.70	1.58	BF0064-0095-0191-BS1316
6.350 (0.250") +0.000/+0.025 (mm)	11.113 +0.025/+0.051	12.700 +/-0.127	12.70	1.59	BF0064-0111-0127-BS1316LT
6.350 (0.250") +0.000/+0.010 (mm)	12.700 -0.010/+0.003	3.175 +0/-0.127	13.89	0.58	BF0064-0127-0032-BSLU
6.350 (0.250") +0.000/+0.010 (mm)	12.700 -0.010/+0.003	4.763 +0/-0.127	13.89	1.14	BF0064-0127-0048-BSLU
6.350 (0.250") +0.025/+0.051 (mm)	12.700 +0.051/+0.076	15.875 +/-0.127	15.88	1.59	BF0064-0127-0159-BS1616TH
6.350 (0.250") +0.025/+0.051 (mm)	12.700 +0.051/+0.076	19.050 +/-0.127	15.88	1.59	BF0064-0127-0191-BS1616TH
6.350 (0.250") +0.000/+0.010 (mm)	15.875 -0.010/+0.003	4.978 +0/-0.127	17.53	1.07	BF0064-0159-0050-BSLU

Stocked or Short Delivery

Usually Available Short Delivery

Long delivery or not in current production

* Large Minimum Quantities

** Available only while stock last:

Bushes - Flanged

Nominal ID (d) mm (inches)	Nominal OD (D) mm	Length (S) mm	Flange OD (D1) mm	Flange Thickness (S1) mm	Part Number
7.000 (0.276") +0.005/+0.030 (mm)	11.000 +0.028/+0.050	8.000 +/-0.127	15.00	2.00	BF0070-0110-0080-BS
7.000 (0.276") +0.025/+0.040 (mm)	12.000 +0.023/+0.041	8.000 +0/-0.200	16.00	3.00	BF0070-0120-0080-BS
7.144 (0.281") +0.000/+0.025 (mm)	9.525 +0.076/+0.102	5.558 +/-0.127	12.70	2.41	BF0071-0095-0056-BSLH
7.938 (0.313") +0.012/+0.038 (mm)	9.525 +0.025/+0.051	9.525 +/-0.191	12.70	1.19	BF0079-0095-0095-BSLT
7.938 (0.313") -0.025/+0.000 (mm)	11.113 +0.038/+0.063	9.525 +/-0.127	14.29	1.59	BF0079-0111-0095-BS1416UH
7.938 (0.313") +0.012/+0.038 (mm)	11.113 +0.012/+0.038	9.525 +/-0.191	15.88	2.38	BF0079-0111-0095-BS1624LL
7.938 (0.313") -0.025/+0.000 (mm)	11.113 +0.038/+0.063	12.700 +/-0.127	14.29	1.59	BF0079-0111-0127-BS1416UH
7.938 (0.313") +0.012/+0.038 (mm)	11.113 +0.012/+0.038	19.050 +/-0.191	15.88	2.38	BF0079-0111-0191-BSLL
7.938 (0.313") -0.025/+0.000 (mm)	11.113 +0.038/+0.063	22.225 +/-0.127	14.29	1.59	BF0079-0111-0222-BS1416UH
7.938 (0.313") +0.025/+0.051 (mm)	12.700 +0.028/+0.046	6.350 +/-0.127	15.88	1.58	BF0079-0127-0064-BS
7.938 (0.313") +0.000/+0.025 (mm)	12.700 +0.025/+0.051	9.525 +/-0.127	14.29	1.59	BF0079-0127-0095-BS1416LT
7.938 (0.313") +0.025/+0.051 (mm)	12.700 +0.028/+0.046	9.525 +/-0.127	15.88	1.58	BF0079-0127-0095-BS1616
7.938 (0.313") +0.012/+0.038 (mm)	12.700 +0.025/+0.051	9.525 +/-0.191	17.46	2.38	BF0079-0127-0095-BS1724LT
7.938 (0.313") +0.000/+0.025 (mm)	12.700 +0.076/+0.102	12.314 +/-0.127	14.27	1.65	BF0079-0127-0123-BSLH
7.938 (0.313") +0.025/+0.051 (mm)	12.700 +0.028/+0.046	12.700 +/-0.127	15.88	1.58	BF0079-0127-0127-BS1616
7.938 (0.313") +0.012/+0.038 (mm)	12.700 +0.025/+0.051	12.700 +/-0.191	17.46	2.38	BF0079-0127-0127-BS1724LT
7.938 (0.313") +0.012/+0.038 (mm)	12.700 +0.025/+0.051	15.875 +/-0.191	17.46	2.38	BF0079-0127-0159-BSLT
7.938 (0.313") +0.025/+0.051 (mm)	12.700 +0.028/+0.046	19.050 +/-0.127	15.88	1.58	BF0079-0127-0191-BS
7.938 (0.313") +0.000/+0.010 (mm)	17.463 -0.010/+0.003	6.350 +0/-0.127	19.05	1.07	BF0079-0175-0064-BSLU
8.000 (0.315") +0.005/+0.030 (mm)	11.000 +0.028/+0.050	6.000 +/-0.120	12.00	1.50	BF0080-0110-0060-BS
8.000 (0.315") +0.005/+0.030 (mm)	11.000 +0.028/+0.050	10.000 +/-0.120	12.00	1.50	BF0080-0110-0100-BS
8.000 (0.315") +0.005/+0.030 (mm)	11.000 +0.028/+0.050	12.000 +/-0.120	14.00	1.50	BF0080-0110-0120-BS
8.000 (0.315") +0.005/+0.030 (mm)	12.000 +0.028/+0.050	6.000 +/-0.127	16.00	2.00	BF0080-0120-0060-BS
8.000 (0.315") +0.005/+0.030 (mm)	12.000 +0.028/+0.050	8.000 +/-0.127	16.00	2.00	BF0080-0120-0080-BS
8.000 (0.315") +0.025/+0.051 (mm)	12.000 +0.023/+0.041	8.000 +/-0.127	16.00	3.00	BF0080-0120-0080-BS1630
8.000 (0.315") +0.005/+0.030 (mm)	12.000 +0.028/+0.050	12.000 +/-0.127	16.00	2.00	BF0080-0120-0120-BS
8.000 (0.315") +0.005/+0.030 (mm)	12.000 +0.028/+0.050	14.000 +/-0.120	16.00	2.00	BF0080-0120-0140-BS
8.000 (0.315") +0.005/+0.030 (mm)	12.000 +0.028/+0.050	16.000 +/-0.127	16.00	2.00	BF0080-0120-0160-BS
8.000 (0.315") +0.000/+0.015 (mm)	16.000 -0.011/+0.000	6.000 +0/-0.170	18.00	1.00	BF0080-0160-0060-BSLU
9.000 (0.354") +0.005/+0.030 (mm)	14.000 +0.028/+0.050	6.000 +/-0.120	19.00	2.50	BF0090-0140-0060-BS
9.000 (0.354") +0.005/+0.030 (mm)	14.000 +0.028/+0.050	10.000 +/-0.120	19.00	2.50	BF0090-0140-0100-BS
9.000 (0.354") +0.005/+0.030 (mm)	14.000 +0.028/+0.050	14.000 +/-0.120	19.00	2.50	BF0090-0140-0140-BS
9.525 (0.375") +0.012/+0.038 (mm)	12.700 +0.025/+0.051	6.350 +/-0.127	15.88	1.59	BF0095-0127-0064-BS1616LT
9.525 (0.375") +0.012/+0.038 (mm)	12.700 +0.025/+0.051	7.938 +/-0.127	15.88	1.59	BF0095-0127-0079-BS1616LT

Stocked or Short Delivery

Usually Available Short Delivery

Long delivery or not in current production

* Large Minimum Quantities

** Available only while stock last:

Bushes - Flanged

Nominal ID (d) mm (inches)	Nominal OD (D) mm	Length (S) mm	Flange OD (D1) mm	Flange Thickness (S1) mm	Part Number
9.525 (0.375") +0.012/+0.038 (mm)	12.700 +0.025/+0.051	9.525 +/-0.127	15.88	1.59	BF0095-0127-0095-BS1616LT
9.525 (0.375") +0.025/+0.051 (mm)	12.700 +0.025/+0.051	9.525	15.880	1.59	BF0095-0127-0095-BS1616
9.525 (0.375") +0.025/+0.051 (mm)	12.700 +0.025/+0.051	9.525 +/-0.191	17.46	2.38	BF0095-0127-0095-BS1724
9.525 (0.375") +0.000/+0.025 (mm)	12.700 +0.076/+0.102	10.262 +/-0.127	14.27	1.65	BF0095-0127-0102-BSLH
9.525 (0.375") +0.025/+0.051 (mm)	12.700 +0.025/+0.051	10.319 +/-0.191	17.46	2.38	BF0095-0127-0103-BS
9.525 (0.375") +0.012/+0.038 (mm)	12.700 +0.025/+0.051	12.700 +/-0.127	15.88	1.59	BF0095-0127-0127-BS1616LT
9.525 (0.375") +0.012/+0.038 (mm)	12.700 +0.051/+0.076	12.700 +/-0.127	15.88	2.38	BF0095-0127-0127-BS1624LH
9.525 (0.375") +0.025/+0.051 (mm)	12.700 +0.028/+0.046	12.700 +/-0.127	15.88	3.56	BF0095-0127-0127-BS1636
9.525 (0.375") +0.025/+0.051 (mm)	12.700 +0.051/+0.076	12.700 +/-0.127	17.45	2.38	BF0095-0127-0127-BS1724TH
9.525 (0.375") +0.051/+0.076 (mm)	12.700 +0.051/+0.076	12.700 +/-0.127	19.05	2.38	BF0095-0127-0127-BS1924HH
9.525 (0.375") +0.012/+0.038 (mm)	12.700 +0.051/+0.076	15.875 +/-0.127	15.88	2.38	BF0095-0127-0159-BS1624LH
9.525 (0.375") +0.025/+0.051 (mm)	12.700 +0.025/+0.051	15.875 +/-0.191	17.46	2.38	BF0095-0127-0159-BS1724
9.525 (0.375") +0.025/+0.051 (mm)	12.700 +0.076/+0.102	17.678 +0/-0.152	14.27	1.65	BF0095-0127-0177-BSLH
9.525 (0.375") +0.025/+0.051 (mm)	12.700 +0.025/+0.051	19.050 +/-0.191	17.46	2.38	BF0095-0127-0191-BS
9.525 (0.375") +0.025/+0.051 (mm)	12.700 +0.028/+0.046	22.225 +/-0.127	15.88	3.56	BF0095-0127-0222-BS
9.525 (0.375") +0.025/+0.051 (mm)	12.700 +0.025/+0.051	25.400 +/-0.191	17.46	2.38	BF0095-0127-0254-BS
9.525 (0.375") +0.025/+0.051 (mm)	12.700 +0.025/+0.051	31.750 +/-0.127	17.46	2.38	* BF0095-0127-0318-BS
9.525 (0.375") +0.000/+0.025 (mm)	14.288 +0.012/+0.038	12.700 +/-0.127	18.80	1.59	BF0095-0143-0127-BS1916LL
9.525 (0.375") +0.025/+0.051 (mm)	14.288 +0.063/+0.089	16.764 +/-0.127	19.05	2.36	BF0095-0143-0168-BSLH
9.525 (0.375") +0.000/+0.025 (mm)	14.288 +0.012/+0.038	17.463 +/-0.127	18.80	1.59	BF0095-0143-0175-BS1916LL
9.525 (0.375") +0.025/+0.051 (mm)	14.288 +0.025/+0.051	19.050 +/-0.191	19.05	3.18	BF0095-0143-0191-BS
9.525 (0.375") +0.000/+0.025 (mm)	14.288 +0.012/+0.038	20.638 +/-0.127	18.80	1.59	BF0095-0143-0206-BS1916LL
9.525 (0.375") +0.025/+0.051 (mm)	14.288 +0.025/+0.051	31.750 +/-0.127	19.05	3.18	BF0095-0143-0318-BS
9.525 (0.375") +0.025/+0.051 (mm)	15.875 +0.028/+0.046	9.525 +/-0.127	19.05	3.18	BF0095-0159-0095-BS
9.525 (0.375") +0.025/+0.051 (mm)	15.875 +0.028/+0.046	12.700 +/-0.127	19.05	3.18	BF0095-0159-0127-BS19
9.525 (0.375") +0.000/+0.025 (mm)	15.875 +0.025/+0.051	12.700 +/-0.127	22.23	1.59	BF0095-0159-0127-BS2216LT
9.525 (0.375") +0.000/+0.025 (mm)	15.875 +0.025/+0.051	12.700 +/-0.127	22.23	3.18	BF0095-0159-0127-BS2232LT
9.525 (0.375") +0.025/+0.051 (mm)	15.875 +0.025/+0.051	12.700	22.230	3.18	BF0095-0159-0127-BS22
9.525 (0.375") +0.051/+0.076 (mm)	15.875 +0.076/+0.102	15.494 +/-0.127	22.23	1.60	BF0095-0159-0159-BS2216HH
9.525 (0.375") +0.025/+0.051 (mm)	15.875 +0.028/+0.046	15.875 +/-0.127	19.05	3.18	BF0095-0159-0159-BS19
9.525 (0.375") +0.025/+0.051 (mm)	15.875 +0.028/+0.046	19.050 +/-0.127	19.05	3.18	BF0095-0159-0191-BS19
9.525 (0.375") +0.000/+0.025 (mm)	15.875 +0.025/+0.051	19.050 +/-0.127	22.23	1.59	BF0095-0159-0191-BS2216LT
9.525 (0.375") +0.025/+0.051 (mm)	15.875 +0.025/+0.051	19.050 +/-0.191	22.23	3.18	BF0095-0159-0191-BS22
9.525 (0.375") +0.025/+0.051 (mm)	15.875 +0.025/+0.051	25.400 +/-0.191	22.23	3.18	BF0095-0159-0254-BS

Stocked or Short Delivery

Usually Available Short Delivery

Long delivery or not in current production

* Large Minimum Quantities

** Available only while stock last:

Bushes - Flanged

Nominal ID (d) mm (inches)	Nominal OD (D) mm	Length (S) mm	Flange OD (D1) mm	Flange Thickness (S1) mm	Part Number
9.525 (0.375") +0.000/+0.025 (mm)	15.875 +0.025/+0.051	31.750 +/-0.127	22.23	1.59	BF0095-0159-0318-BS2216LT
9.525 (0.375") +0.025/+0.051 (mm)	15.875 +0.025/+0.051	31.750 +/-0.127	22.23	3.18	BF0095-0159-0318-BS2232
9.525 (0.375") +0.025/+0.051 (mm)	19.050 +0.051/+0.076	12.700 +/-0.191	25.40	3.18	BF0095-0191-0127-BSTH
10.000 (0.394") +0.005/+0.030 (mm)	13.000 +0.028/+0.050	6.000 +/-0.120	16.00	1.50	BF0100-0130-0060-BS
10.000 (0.394") +0.005/+0.030 (mm)	13.000 +0.028/+0.050	8.000 +/-0.120	16.00	1.50	BF0100-0130-0080-BS
10.000 (0.394") +0.005/+0.030 (mm)	13.000 +0.028/+0.050	10.000 +/-0.120	16.00	1.50	BF0100-0130-0100-BS
10.000 (0.394") +0.005/+0.030 (mm)	13.000 +0.028/+0.050	12.000 +/-0.120	16.00	1.50	BF0100-0130-0120-BS
10.000 (0.394") +0.005/+0.030 (mm)	13.000 +0.028/+0.050	16.000 +/-0.120	16.00	1.50	BF0100-0130-0160-BS
10.000 (0.394") +0.005/+0.030 (mm)	13.000 +0.028/+0.050	20.000 +/-0.120	16.00	1.50	BF0100-0130-0200-BS
10.000 (0.394") +0.005/+0.030 (mm)	15.000 +0.028/+0.050	10.000 +/-0.127	20.00	2.50	BF0100-0150-0100-BS2025LT
10.000 (0.394") +0.005/+0.030 (mm)	15.000 +0.028/+0.050	10.000 +/-0.127	20.00	3.00	BF0100-0150-0100-BS2030
10.000 (0.394") +0.005/+0.030 (mm)	15.000 +0.028/+0.050	10.000 +/-0.127	21.00	3.00	BF0100-0150-0100-BS2130
10.000 (0.394") +0.005/+0.030 (mm)	15.000 +0.028/+0.050	16.000 +/-0.127	20.00	2.50	BF0100-0150-0160-BS2025LT
10.000 (0.394") +0.005/+0.030 (mm)	15.000 +0.028/+0.050	16.000 +/-0.127	20.00	3.00	BF0100-0150-0160-BS2030
10.000 (0.394") +0.005/+0.030 (mm)	15.000 +0.028/+0.050	16.000 +/-0.127	21.00	3.00	BF0100-0150-0160-BS2130
10.000 (0.394") +0.005/+0.030 (mm)	15.000 +0.028/+0.050	20.000 +/-0.127	21.00	3.00	BF0100-0150-0200-BS
10.000 (0.394") +0.025/+0.040 (mm)	16.000 +0.023/+0.050	8.000 +0/-0.200	20.00	3.00	BF0100-0160-0080-BS2030
10.000 (0.394") +0.005/+0.030 (mm)	16.000 +0.028/+0.050	8.000 +/-0.127	22.00	3.00	BF0100-0160-0080-BS2230
10.000 (0.394") +0.025/+0.040 (mm)	16.000 +0.023/+0.041	10.000 +0/-0.200	20.00	3.00	BF0100-0160-0100-BS2030
10.000 (0.394") +0.005/+0.030 (mm)	16.000 +0.028/+0.050	10.000 +/-0.127	22.00	3.00	BF0100-0160-0100-BS2230LT
10.000 (0.394") +0.025/+0.051 (mm)	16.000 +0.028/+0.046	16.000 +/-0.127	20.00	3.00	BF0100-0160-0160-BS2030
10.000 (0.394") +0.005/+0.030 (mm)	16.000 +0.028/+0.050	16.000 +/-0.127	22.00	3.00	BF0100-0160-0160-BS
10.000 (0.394") +0.000/+0.015 (mm)	19.000 -0.013/+0.000	7.000 +0/-0.170	21.00	1.50	BF0100-0190-0070-BSLU
11.113 (0.438") +0.012/+0.038 (mm)	12.700 +0.076/+0.102	3.912 +/-0.127	14.27	1.96	BF0111-0127-0039-BSLH
11.113 (0.438") +0.012/+0.038 (mm)	14.288 +0.051/+0.076	7.137 +/-0.127	19.84	1.65	BF0111-0143-0071-BSLH
11.113 (0.438") +0.012/+0.038 (mm)	14.288 +0.038/+0.063	12.700 +/-0.127	17.46	1.59	BF0111-0143-0127-BS1716LH
11.113 (0.438") +0.012/+0.038 (mm)	14.288 +0.051/+0.076	13.868 +/-0.127	19.84	1.65	BF0111-0143-0139-BSLH
11.113 (0.438") +0.012/+0.038 (mm)	14.288 +0.038/+0.063	15.875 +/-0.127	17.46	1.59	BF0111-0143-0159-BSLH
11.113 (0.438") +0.012/+0.038 (mm)	14.288 +0.038/+0.063	19.050 +/-0.127	17.46	1.59	BF0111-0143-0191-BS1716LH
11.113 (0.438") +0.012/+0.038 (mm)	15.875 +0.025/+0.051	15.875 +/-0.191	22.23	3.18	BF0111-0159-0159-BS2232LT
11.113 (0.438") +0.013/+0.038 (mm)	15.875 +0.051/+0.076	15.875	22.230	3.18	BF0111-0159-0159-BS2232LH
11.113 (0.438") +0.000/+0.025 (mm)	15.875 +0.025/+0.051	19.050 +/-0.127	22.23	3.18	BF0111-0159-0191-BS2232LT
11.113 (0.438") +0.000/+0.025 (mm)	15.875 +0.025/+0.051	31.750 +/-0.127	22.22	3.18	BF0111-0159-0318-BS2232LT
11.113 (0.438") +0.013/+0.038 (mm)	15.875 +0.051/+0.076	31.750	22.230	3.18	BF0111-0159-0318-BS2232LH

 Stocked or Short Delivery

 Usually Available Short Delivery

 Long delivery or not in current production

* Large Minimum Quantities

** Available only while stock last:

Bushes - Flanged

Nominal ID (d) mm (inches)	Nominal OD (D) mm	Length (S) mm	Flange OD (D1) mm	Flange Thickness (S1) mm	Part Number
12.000 (0.472") +0.005/+0.030 (mm)	15.000 +0.028/+0.050	7.000 +/-0.127	18.00	1.50	BF0120-0150-0070-BSLT
12.000 (0.472") +0.005/+0.030 (mm)	15.000 +0.028/+0.050	12.000 +/-0.127	18.00	1.50	BF0120-0150-0120-BSLT
12.000 (0.472") +0.005/+0.030 (mm)	15.000 +0.028/+0.050	16.000 +/-0.127	18.00	1.50	BF0120-0150-0160-BSLT
12.000 (0.472") +0.005/+0.030 (mm)	15.000 +0.028/+0.050	20.000 +/-0.127	18.00	1.50	BF0120-0150-0200-BSLT
12.000 (0.472") +0.025/+0.051 (mm)	15.000 +0.028/+0.046	20.000 +/-0.127	21.00	3.00	BF0120-0150-0200-BS
12.000 (0.472") +0.005/+0.030 (mm)	16.000 +0.028/+0.050	12.000 +/-0.127	20.00	2.00	BF0120-0160-0120-BSLT
12.000 (0.472") +0.005/+0.030 (mm)	17.000 +0.028/+0.050	12.000 +/-0.127	22.00	2.50	BF0120-0170-0120-BSLT
12.000 (0.472") +0.005/+0.030 (mm)	16.000 +0.028/+0.050	16.000 +/-0.127	20.00	2.00	BF0120-0160-0160-BSLT
12.000 (0.472") +0.005/+0.030 (mm)	17.000 +0.028/+0.050	16.000 +/-0.127	22.00	2.50	BF0120-0170-0160-BSLT
12.000 (0.472") +0.005/+0.030 (mm)	17.000 +0.028/+0.050	20.000 +/-0.127	22.00	2.50	BF0120-0170-0200-BSLT
12.000 (0.472") +0.005/+0.030 (mm)	16.000 +0.028/+0.050	25.000 +/-0.127	20.00	2.00	BF0120-0160-0250-BSLT
12.000 (0.472") +0.005/+0.030 (mm)	17.000 +0.028/+0.050	25.000 +/-0.127	22.00	2.50	BF0120-0170-0250-BSLT
12.000 (0.472") +0.005/+0.030 (mm)	18.000 +0.028/+0.050	8.000 +/-0.127	24.00	3.00	BF0120-0180-0080-BS
12.000 (0.472") +0.005/+0.030 (mm)	18.000 +0.028/+0.050	10.000 +0/-0.200	22.00	3.00	BF0120-0180-0100-BS2230TL
12.000 (0.472") +0.005/+0.030 (mm)	18.000 +0.028/+0.050	10.000 +/-0.127	24.00	3.00	BF0120-0180-0100-BS2430LT
12.000 (0.472") +0.032/+0.050 (mm)	18.000 +0.023/+0.041	12.000 +0/-0.200	22.00	3.00	BF0120-0180-0120-BS2230
12.000 (0.472") +0.005/+0.030 (mm)	18.000 +0.028/+0.050	12.000 +/-0.127	24.00	3.00	BF0120-0180-0120-BS2430
12.000 (0.472") +0.005/+0.030 (mm)	18.000 +0.028/+0.050	16.000 +/-0.127	24.00	3.00	BF0120-0180-0160-BSLT
12.000 (0.472") +0.005/+0.030 (mm)	18.000 +0.028/+0.050	20.000 +/-0.127	24.00	3.00	BF0120-0180-0200-BSLT
12.000 (0.472") +0.000/+0.018 (mm)	20.000 -0.013/+0.000	8.000 +0/-0.170	22.00	1.50	BF0120-0200-0080-BSLU
12.700 (0.500") +0.025/+0.051 (mm)	15.875 +0.076/+0.102	3.531 -0.178/+0	22.23	1.27	BF0127-0159-0035-BSTH
12.700 (0.500") +0.000/+0.025 (mm)	15.875 +0.051/+0.076	5.029 +0/-0.152	22.10	1.07	BF0127-0159-0050-BSLH
12.700 (0.500") +0.025/+0.051 (mm)	15.875 +0.076/+0.102	6.350 +/-0.127	20.62	2.41	BF0127-0159-0064-BSTH
12.700 (0.500") +0.025/+0.051 (mm)	15.875 +0.076/+0.102	7.798 +/-0.127	22.23	1.65	BF0127-0159-0078-BSTH
12.700 (0.500") +0.025/+0.051 (mm)	15.875 +0.025/+0.051	7.938 +/-0.127	19.05	2.38	BF0127-0159-0079-BS
12.700 (0.500") +0.025/+0.051 (mm)	15.875 +0.025/+0.051	9.525 +/-0.127	19.05	2.38	BF0127-0159-0095-BS1924
12.700 (0.500") +0.025/+0.051 (mm)	15.875 +0.051/+0.076	9.525	22.230	3.18	BF0127-0159-0095-BS2232TH
12.700 (0.500") +0.025/+0.051 (mm)	15.875 +0.028/+0.046	12.700 +/-0.127	19.05	2.38	* BF0127-0159-0127-BS1924
12.700 (0.500") +0.025/+0.051 (mm)	15.875 +0.025/+0.051	12.700 +/-0.127	22.23	1.59	BF0127-0159-0127-BS2216
12.700 (0.500") +0.025/+0.051 (mm)	15.875 +0.025/+0.051	12.700 +/-0.191	22.23	3.18	BF0127-0159-0127-BS2232
12.700 (0.500") +0.025/+0.051 (mm)	15.875 +0.051/+0.076	12.700	22.230	3.18	BF0127-0159-0127-BS2232TH
12.700 (0.500") +0.025/+0.051 (mm)	15.875 +0.025/+0.051	12.700	24.610	2.38	BF0127-0159-0127-BS2524
12.700 (0.500") +0.025/+0.051 (mm)	15.875 +0.076/+0.102	14.275 +/-0.127	22.23	1.65	BF0127-0159-0143-BSTH
12.700 (0.500") +0.025/+0.051 (mm)	15.875 +0.025/+0.051	14.275	22.230	1.59	BF0127-0159-0143-BS2216

 Stocked or Short Delivery

 Usually Available Short Delivery

 Long delivery or not in current production

* Large Minimum Quantities

** Available only while stock last:

Bushes - Flanged

Nominal ID (d) mm (inches)	Nominal OD (D) mm	Length (S) mm	Flange OD (D1) mm	Flange Thickness (S1) mm	Part Number
12.700 (0.500") +0.025/+0.051 (mm)	15.875 +0.025/+0.051	15.875 +/-0.191	22.23	3.18	BF0127-0159-0159-BS2232
12.700 (0.500") +0.025/+0.051 (mm)	15.875 +0.025/+0.051	15.875	22.230	1.59	BF0127-0159-0159-BS2216
12.700 (0.500") +0.025/+0.051 (mm)	15.875 +0.051/+0.076	15.875	22.230	3.18	BF0127-0159-0159-BS2232TH
12.700 (0.500") +0.025/+0.051 (mm)	15.875 +0.025/+0.051	17.463 +/-0.127	22.23	1.59	BF0127-0159-0175-BS
12.700 (0.500") +0.025/+0.051 (mm)	15.875 +0.025/+0.051	19.050	22.230	1.59	BF0127-0159-0191-BS2216
12.700 (0.500") +0.025/+0.051 (mm)	15.875 +0.051/+0.076	19.050	22.230	3.18	BF0127-0159-0191-BS2232TH
12.700 (0.500") +0.025/+0.051 (mm)	15.875 +0.025/+0.051	23.813 +/-0.127	22.23	1.59	BF0127-0159-0238-BS
12.700 (0.500") +0.025/+0.051 (mm)	15.875 +0.028/+0.046	25.400 +/-0.127	19.05	2.38	BF0127-0159-0254-BS1924
12.700 (0.500") +0.025/+0.051 (mm)	15.875 +0.025/+0.051	25.400 +/-0.127	22.23	1.59	BF0127-0159-0254-BS2216
12.700 (0.500") +0.025/+0.051 (mm)	15.875 +0.051/+0.076	25.400 +/-0.127	22.23	3.18	BF0127-0159-0254-BS2232TH
12.700 (0.500") +0.025/+0.051 (mm)	15.875 +0.025/+0.051	25.400 +/-0.127	24.61	2.38	BF0127-0159-0254-BS2524
12.700 (0.500") +0.025/+0.051 (mm)	15.875 +0.025/+0.051	28.575 +/-0.127	22.23	1.59	BF0127-0159-0286-BS
12.700 (0.500") +0.025/+0.051 (mm)	15.875 +0.025/+0.051	31.750 +/-0.127	22.23	3.18	** BF0127-0159-0318-BS2232
12.700 (0.500") +0.025/+0.051 (mm)	15.875 +0.051/+0.076	31.750	22.230	3.18	BF0127-0159-0318-BS2232TH
12.700 (0.500") +0.025/+0.051 (mm)	15.875 +0.051/+0.076	38.100	22.230	3.18	BF0127-0159-0381-BS2232TH
12.700 (0.500") +0.025/+0.051 (mm)	15.875 +0.051/+0.076	44.450	22.230	3.18	BF0127-0159-0445-BS2232TH
12.700 (0.500") +0.025/+0.051 (mm)	15.875 +0.025/+0.051	44.450 +/-0.190	24.61	2.38	BF0127-0159-0445-BS2524
12.700 (0.500") +0.025/+0.051 (mm)	17.463 +0.063/+0.089	7.938 +/-0.127	20.64	1.59	BF0127-0175-0079-BS2116TH
12.700 (0.500") +0.025/+0.051 (mm)	17.463 +0.063/+0.089	12.700 +/-0.127	20.64	1.59	BF0127-0175-0127-BS2116TH
12.700 (0.500") +0.025/+0.051 (mm)	17.463 -0.019/+0.006	12.700	23.810	3.18	BF0127-0175-0127-BS2432TU
12.700 (0.500") +0.025/+0.051 (mm)	17.463 +0.038/+0.063	12.700 +/-0.191	23.84	3.18	BF0127-0175-0127-BS2432TH
12.700 (0.500") +0.025/+0.051 (mm)	17.463 +0.063/+0.089	12.700 +/-0.127	24.61	2.38	BF0127-0175-0127-BS2524TH
12.700 (0.500") +0.025/+0.051 (mm)	17.463 +0.063/+0.089	19.050 +/-0.127	20.64	1.59	BF0127-0175-0191-BS2116TH
12.700 (0.500") +0.025/+0.051 (mm)	17.463 -0.019/+0.006	19.050	23.810	3.18	BF0127-0175-0191-BS2432TU
12.700 (0.500") +0.025/+0.051 (mm)	17.463 +0.038/+0.063	19.050 +/-0.191	23.84	3.18	BF0127-0175-0191-BS2432TH
12.700 (0.500") +0.025/+0.051 (mm)	17.463 +0.063/+0.089	19.050 +/-0.127	24.61	2.38	BF0127-0175-0191-BS2524TH
12.700 (0.500") +0.025/+0.051 (mm)	17.463 +0.063/+0.089	20.638 +/-0.127	24.61	2.38	BF0127-0175-0206-BS2524TH
12.700 (0.500") +0.025/+0.051 (mm)	17.463 +0.063/+0.089	30.163 +/-0.127	20.64	1.59	BF0127-0175-0302-BS2116TH
12.700 (0.500") +0.102/+0.127 (mm)	19.050 +0.051/+0.076	9.525 +/-0.127	25.40	3.18	BF0127-0191-0095-BSHH
12.700 (0.500") +0.025/+0.051 (mm)	19.050 +0.051/+0.076	12.700 +/-0.127	23.81	3.18	BF0127-0191-0127-BS2432TH
12.700 (0.500") +0.025/+0.051 (mm)	19.050 +0.051/+0.076	12.700 +/-0.127	25.40	3.18	BF0127-0191-0127-BS2532TH
12.700 (0.500") +0.102/+0.127 (mm)	19.050 +0.051/+0.076	12.700 +/-0.127	25.40	3.18	BF0127-0191-0127-BS2532HH
12.700 (0.500") +0.025/+0.051 (mm)	19.050 +0.076/+0.102	13.081 +/-0.127	22.23	3.68	BF0127-0191-0131-BSTH
12.700 (0.500") +0.025/+0.051 (mm)	19.050 +0.051/+0.076	14.684 +/-0.127	25.40	3.18	BF0127-0191-0147-BSTH

 Stocked or Short Delivery

 Usually Available Short Delivery

 Long delivery or not in current production

* Large Minimum Quantities

** Available only while stock last:

Bushes - Flanged

Nominal ID (d) mm (inches)	Nominal OD (D) mm	Length (S) mm	Flange OD (D1) mm	Flange Thickness (S1) mm	Part Number
12.700 (0.500") +0.102/+0.127 (mm)	19.050 +0.051/+0.076	15.875 +/-0.127	25.40	3.18	BF0127-0191-0159-BS2532HH
12.700 (0.500") +0.025/+0.051 (mm)	19.050 +0.051/+0.076	15.875 +/-0.191	25.40	3.18	BF0127-0191-0159-BS2532TH
12.700 (0.500") +0.051/+0.076 (mm)	19.050 +0.051/+0.076	19.050 +/-0.127	23.81	3.18	BF0127-0191-0191-BS2432HH
12.700 (0.500") +0.025/+0.051 (mm)	19.050 +0.051/+0.076	19.050 +/-0.127	23.81	3.18	BF0127-0191-0191-BS2432TH
12.700 (0.500") +0.025/+0.051 (mm)	19.050 +0.051/+0.076	19.050 +/-0.127	25.40	3.18	BF0127-0191-0191-BS2532TH
12.700 (0.500") +0.025/+0.051 (mm)	19.050 +0.051/+0.076	22.225 +/-0.191	25.40	3.18	BF0127-0191-0222-BSTH
12.700 (0.500") +0.025/+0.051 (mm)	19.050 +0.076/+0.102	24.613 +/-0.127	22.23	1.52	BF0127-0191-0246-BSTH
12.700 (0.500") +0.025/+0.051 (mm)	19.050 +0.051/+0.076	25.400 +/-0.127	23.81	3.18	BF0127-0191-0254-BS2430TH
12.700 (0.500") +0.025/+0.051 (mm)	19.050 +0.051/+0.076	25.400 +/-0.191	25.40	3.18	BF0127-0191-0254-BS2532TH
12.700 (0.500") +0.025/+0.051 (mm)	19.050 +0.051/+0.076	31.750 +/-0.127	25.40	3.18	BF0127-0191-0318-BSTH
12.700 (0.500") +0.025/+0.051 (mm)	19.050 +0.051/+0.076	38.100 +/-0.127	25.40	3.18	BF0127-0191-0381-BSTH
12.700 (0.500") +0.000/+0.010 (mm)	28.575 -0.010/+0.003	7.938 +0/-0.127	31.75	1.57	BF0127-0286-0079-BSLU
14.000 (0.551") +0.025/+0.051 (mm)	18.000 +0.035/+0.056	12.000 +/-0.127	22.00	2.00	BF0140-0180-0120-BSLT
14.000 (0.551") +0.025/+0.051 (mm)	18.000 +0.035/+0.056	14.000 +/-0.127	22.00	2.00	BF0140-0180-0140-BSLT
14.000 (0.551") +0.025/+0.051 (mm)	18.000 +0.035/+0.056	18.000 +/-0.127	22.00	2.00	BF0140-0180-0180-BSLT
14.000 (0.551") +0.025/+0.051 (mm)	18.000 +0.035/+0.056	20.000 +/-0.127	22.00	2.00	BF0140-0180-0200-BSLT
14.000 (0.551") +0.025/+0.051 (mm)	18.000 +0.035/+0.056	22.000 +/-0.127	22.00	2.00	BF0140-0180-0220-BSLT
14.000 (0.551") +0.005/+0.030 (mm)	20.000 +0.035/+0.060	10.000 +/-0.127	26.00	3.00	BF0140-0200-0100-BS
14.000 (0.551") +0.005/+0.030 (mm)	20.000 +0.035/+0.060	14.000 +/-0.127	26.00	3.00	BF0140-0200-0140-BS
14.000 (0.551") +0.025/+0.051 (mm)	20.000 +0.035/+0.056	18.000 +/-0.127	26.00	3.00	BF0140-0200-0180-BSLT
14.000 (0.551") +0.025/+0.051 (mm)	20.000 +0.035/+0.056	20.000 +/-0.127	26.00	3.00	BF0140-0200-0200-BS
14.000 (0.551") +0.025/+0.051 (mm)	20.000 +0.035/+0.056	22.000 +/-0.127	26.00	3.00	BF0140-0200-0220-BSLT
14.000 (0.551") +0.025/+0.051 (mm)	20.000 +0.035/+0.056	28.000 +/-0.127	26.00	3.00	BF0140-0200-0280-BSLT
14.288 (0.563") +0.038/+0.063 (mm)	19.050 +0.051/+0.076	25.400 +/-0.191	25.40	3.18	BF0143-0191-0254-BSHH
15.000 (0.591") +0.005/+0.030 (mm)	19.000 +0.035/+0.060	15.000 +/-0.120	23.00	2.00	BF0150-0190-0150-BS
15.000 (0.591") +0.005/+0.030 (mm)	19.000 +0.035/+0.060	16.000 +/-0.120	23.00	2.00	BF0150-0190-0160-BS
15.000 (0.591") +0.005/+0.030 (mm)	19.000 +0.035/+0.060	20.000 +/-0.120	23.00	2.00	BF0150-0190-0200-BS
15.000 (0.591") +0.005/+0.030 (mm)	19.000 +0.035/+0.060	25.000 +/-0.120	23.00	2.00	BF0150-0190-0250-BS
15.000 (0.591") +0.005/+0.030 (mm)	21.000 +0.035/+0.060	10.000 +/-0.127	27.00	3.00	BF0150-0210-0100-BSLT
15.000 (0.591") +0.005/+0.030 (mm)	21.000 +0.035/+0.060	15.000 +/-0.127	27.00	3.00	BF0150-0210-0150-BS
15.000 (0.591") +0.005/+0.030 (mm)	21.000 +0.035/+0.060	16.000 +/-0.120	27.00	3.00	BF0150-0210-0160-BS
15.000 (0.591") +0.005/+0.030 (mm)	21.000 +0.035/+0.060	20.000 +/-0.127	27.00	3.00	BF0150-0210-0200-BSLT
15.000 (0.591") +0.005/+0.030 (mm)	21.000 +0.035/+0.060	25.000 +/-0.127	27.00	3.00	BF0150-0210-0250-BS
15.000 (0.591") +0.005/+0.030 (mm)	21.000 +0.035/+0.060	32.000 +/-0.120	27.00	3.00	BF0150-0210-0320-BS

 Stocked or Short Delivery

 Usually Available Short Delivery

 Long delivery or not in current production

* Large Minimum Quantities

** Available only while stock last:

Bushes - Flanged

Nominal ID (d) mm (inches)	Nominal OD (D) mm	Length (S) mm	Flange OD (D1) mm	Flange Thickness (S1) mm	Part Number
15.000 (0.591") +0.005/+0.030 (mm)	22.000 +0.035/+0.060	12.000 +/-0.120	28.00	3.00	BF0150-0220-0120-BS
15.000 (0.591") +0.005/+0.030 (mm)	22.000 +0.035/+0.060	15.000 +/-0.120	28.00	3.00	BF0150-0220-0150-BS
15.875 (0.625") +0.025/+0.051 (mm)	19.050 +0.063/+0.089	5.842 +/-0.127	22.23	3.68	BF0159-0191-0058-BSTH
15.875 (0.625") +0.025/+0.051 (mm)	19.050 +0.063/+0.089	9.423 +/-0.127	25.17	1.60	BF0159-0191-0094-BSTH
15.875 (0.625") +0.038/+0.063 (mm)	19.050 +0.038/+0.063	12.700 +/-0.127	22.23	1.59	BF0159-0191-0127-BS2216HH
15.875 (0.625") +0.000/+0.025 (mm)	19.050 +0.051/+0.076	12.700 +/-0.191	25.40	3.18	BF0159-0191-0127-BS2532LH
15.875 (0.625") +0.025/+0.051 (mm)	19.050 +0.035/+0.056	12.700 +/-0.127	28.58	2.39	BF0159-0191-0127-BS2924
15.875 (0.625") +0.012/+0.038 (mm)	19.050 +0.038/+0.063	15.875 +/-0.127	25.40	2.38	BF0159-0191-0159-BS2524LH
15.875 (0.625") +0.000/+0.025 (mm)	19.050 +0.051/+0.076	15.875 +/-0.191	25.40	3.18	BF0159-0191-0159-BS2532LH
15.875 (0.625") +0.025/+0.051 (mm)	19.050 +0.063/+0.089	16.002 +/-0.127	25.17	1.60	BF0159-0191-0160-BSTH
15.875 (0.625") +0.012/+0.038 (mm)	19.050 +0.038/+0.063	19.050 +/-0.127	25.40	2.38	BF0159-0191-0191-BS2524LH
15.875 (0.625") +0.000/+0.025 (mm)	19.050 +0.051/+0.076	19.050 +/-0.191	25.40	3.18	BF0159-0191-0191-BS2532LH
15.875 (0.625") +0.038/+0.063 (mm)	19.050 +0.038/+0.063	25.400 +/-0.127	22.23	1.59	BF0159-0191-0254-BS2216HH
15.875 (0.625") +0.012/+0.038 (mm)	19.050 +0.038/+0.063	25.400 +/-0.127	25.40	2.38	BF0159-0191-0254-BS2524LH
15.875 (0.625") +0.000/+0.025 (mm)	19.050 +0.051/+0.076	25.400 +/-0.127	25.40	3.18	BF0159-0191-0254-BS2532LH
15.875 (0.625") +0.025/+0.051 (mm)	19.050 +0.035/+0.056	25.400 +/-0.127	28.58	2.39	BF0159-0191-0254-BS2924
15.875 (0.625") +0.038/+0.063 (mm)	19.050 +0.038/+0.063	28.575 +/-0.127	22.23	1.59	BF0159-0191-0286-BS2216HH
15.875 (0.625") +0.012/+0.038 (mm)	19.050 +0.038/+0.063	28.575 +/-0.127	25.40	2.38	BF0159-0191-0286-BS2524LH
15.875 (0.625") +0.012/+0.038 (mm)	19.050 +0.038/+0.063	31.750 +/-0.127	25.40	2.38	BF0159-0191-0318-BS2524LH
15.875 (0.625") +0.000/+0.025 (mm)	19.050 +0.051/+0.076	31.750 +/-0.127	25.40	3.18	BF0159-0191-0318-BS2532LH
15.875 (0.625") +0.088/+0.114 (mm)	20.638 +0.051/+0.076	12.700 +/-0.127	25.40	3.18	BF0159-0206-0127-BS2532HH
15.875 (0.625") +0.000/+0.025 (mm)	20.638 +0.038/+0.063	12.700 +/-0.127	25.40	3.18	BF0159-0206-0127-BS2532LH
15.875 (0.625") +0.088/+0.114 (mm)	20.638 +0.051/+0.076	19.050 +/-0.127	25.40	3.18	BF0159-0206-0191-BS2532HH
15.875 (0.625") +0.000/+0.025 (mm)	20.638 +0.038/+0.063	19.050 +/-0.127	25.40	3.18	BF0159-0206-0191-BS2532LH
15.875 (0.625") +0.025/+0.051 (mm)	20.638 +0.038/+0.063	19.050 +/-0.191	26.99	3.97	BF0159-0206-0191-BS2740TH
15.875 (0.625") +0.051/+0.076 (mm)	20.638 +0.063/+0.089	19.050 +/-0.127	31.75	3.18	BF0159-0206-0191-BS3232HH
15.875 (0.625") +0.088/+0.114 (mm)	20.638 +0.051/+0.076	25.400 +/-0.127	25.40	3.18	BF0159-0206-0254-BS2532HH
15.875 (0.625") +0.000/+0.025 (mm)	20.638 +0.038/+0.063	25.400 +/-0.127	25.40	3.18	BF0159-0206-0254-BS2532LH
15.875 (0.625") -0.025/+0.000 (mm)	20.638 +0.038/+0.063	25.400 +/-0.127	25.40	3.18	BF0159-0206-0254-BS2532UH
15.875 (0.625") +0.025/+0.051 (mm)	20.638 +0.038/+0.063	25.400 +/-0.127	26.99	3.97	BF0159-0206-0254-BS2740TH
15.875 (0.625") -0.025/+0.000 (mm)	20.638 +0.038/+0.063	31.750 +/-0.127	25.40	3.18	BF0159-0206-0318-BS2532UH
15.875 (0.625") +0.025/+0.051 (mm)	20.638 +0.038/+0.063	31.750 +/-0.127	26.99	3.97	BF0159-0206-0318-BS2740TH
15.875 (0.625") +0.025/+0.051 (mm)	20.638 +0.038/+0.063	36.512 +/-0.127	26.99	3.97	BF0159-0206-0365-BS2740TH
15.875 (0.625") +0.051/+0.076 (mm)	20.638 +0.063/+0.089	36.512 +/-0.127	31.75	3.18	BF0159-0206-0365-BS3232HH

 Stocked or Short Delivery

 Usually Available Short Delivery

 Long delivery or not in current production

* Large Minimum Quantities

** Available only while stock last:

Bushes - Flanged

Nominal ID (d) mm (inches)	Nominal OD (D) mm	Length (S) mm	Flange OD (D1) mm	Flange Thickness (S1) mm	Part Number
15.875 (0.625") +0.025/+0.051 (mm)	20.638 +0.038/+0.063	38.100 +/-0.127	26.99	3.97	BF0159-0206-0381-BSTH
15.875 (0.625") +0.025/+0.051 (mm)	20.638 +0.038/+0.063	50.800 +/-0.190	26.99	3.97	BF0159-0206-0508-BSTH
15.875 (0.625") +0.025/+0.051 (mm)	22.225 +0.035/+0.056	12.700 +/-0.127	31.75	3.18	BF0159-0222-0127-BS
15.875 (0.625") +0.025/+0.051 (mm)	22.225 +0.025/+0.051	15.875 +/-0.127	25.40	3.18	BF0159-0222-0159-BS
15.875 (0.625") +0.025/+0.051 (mm)	22.225 +0.025/+0.051	19.050 +/-0.127	25.40	3.18	BF0159-0222-0191-BS2532
15.875 (0.625") +0.025/+0.051 (mm)	22.225 +0.051/+0.076	19.050 +/-0.127	28.58	3.97	BF0159-0222-0191-BS2940TH
15.875 (0.625") +0.025/+0.051 (mm)	22.225 +0.035/+0.056	19.050 +/-0.127	31.75	3.18	BF0159-0222-0191-BS3232
15.875 (0.625") +0.025/+0.051 (mm)	22.225 +0.025/+0.051	25.400 +/-0.127	25.40	3.18	BF0159-0222-0254-BS2532
15.875 (0.625") +0.025/+0.051 (mm)	22.225 +0.025/+0.051	25.400 +/-0.127	28.58	3.18	BF0159-0222-0254-BS2932
15.875 (0.625") +0.025/+0.051 (mm)	22.225 +0.051/+0.076	25.400 +/-0.191	28.58	3.97	BF0159-0222-0254-BS2940TH
15.875 (0.625") +0.025/+0.051 (mm)	22.225 +0.035/+0.056	25.400 +/-0.127	31.75	3.18	** BF0159-0222-0254-BS3232
15.875 (0.625") +0.025/+0.051 (mm)	22.225 +0.025/+0.051	31.750 +/-0.127	25.40	3.18	BF0159-0222-0318-BS
15.875 (0.625") +0.025/+0.051 (mm)	22.225 +0.051/+0.076	44.450 +/-0.190	28.58	3.97	BF0159-0222-0445-BSTH
15.875 (0.625") +0.025/+0.051 (mm)	25.400 +0.051/+0.076	25.400 +/-0.127	31.75	3.97	BF0159-0254-0254-BS3240TH
16.000 (0.630") +0.005/+0.030 (mm)	20.000 +0.035/+0.060	12.000 +/-0.120	24.00	2.00	BF0160-0200-0120-BS2420
16.000 (0.630") +0.005/+0.030 (mm)	20.000 +0.035/+0.060	16.000 +/-0.120	24.00	2.00	BF0160-0200-0160-BS2420
16.000 (0.630") +0.025/+0.051 (mm)	20.000 +0.035/+0.056	16.000 +/-0.127	27.00	3.00	BF0160-0200-0160-BS
16.000 (0.630") +0.005/+0.030 (mm)	20.000 +0.035/+0.060	20.000 +/-0.120	24.00	2.00	BF0160-0200-0200-BS2420
16.000 (0.630") +0.025/+0.051 (mm)	20.000 +0.035/+0.056	20.000 +/-0.127	27.00	3.00	BF0160-0200-0200-BS
16.000 (0.630") +0.005/+0.030 (mm)	20.000 +0.035/+0.060	25.000 +/-0.120	24.00	2.00	BF0160-0200-0250-BS2420
16.000 (0.630") +0.025/+0.051 (mm)	20.000 +0.035/+0.056	25.000 +/-0.127	27.00	3.00	BF0160-0200-0250-BS
16.000 (0.630") +0.005/+0.030 (mm)	22.000 +0.035/+0.060	12.000 +/-0.127	28.00	3.00	BF0160-0220-0120-BSLT
16.000 (0.630") +0.005/+0.030 (mm)	22.000 +0.035/+0.060	16.000 +/-0.127	28.00	3.00	BF0160-0220-0160-BSLT
16.000 (0.630") +0.005/+0.030 (mm)	22.000 +0.035/+0.060	20.000 +/-0.127	28.00	3.00	BF0160-0220-0200-BS
16.000 (0.630") +0.005/+0.030 (mm)	22.000 +0.035/+0.060	25.000 +/-0.127	28.00	3.00	BF0160-0220-0250-BS
16.000 (0.630") +0.005/+0.030 (mm)	22.000 +0.035/+0.060	32.000 +/-0.120	28.00	3.00	BF0160-0220-0320-BS
18.000 (0.709") +0.005/+0.030 (mm)	22.000 +0.035/+0.060	18.000 +/-0.120	26.00	2.00	BF0180-0220-0180-BS
18.000 (0.709") +0.005/+0.030 (mm)	22.000 +0.035/+0.060	20.000 +/-0.120	26.00	2.00	BF0180-0220-0200-BS
18.000 (0.709") +0.005/+0.030 (mm)	22.000 +0.035/+0.060	22.000 +/-0.120	26.00	2.00	BF0180-0220-0220-BS
18.000 (0.709") +0.005/+0.030 (mm)	24.000 +0.035/+0.060	12.000 +/-0.127	30.00	3.00	BF0180-0240-0120-BS
18.000 (0.709") +0.005/+0.030 (mm)	24.000 +0.035/+0.060	18.000 +/-0.127	30.00	3.00	BF0180-0240-0180-BS
18.000 (0.709") +0.005/+0.030 (mm)	24.000 +0.035/+0.060	22.000 +/-0.127	30.00	3.00	BF0180-0240-0220-BS
18.000 (0.709") +0.005/+0.030 (mm)	24.000 +0.035/+0.060	28.000 +/-0.127	30.00	3.00	BF0180-0240-0280-BS
18.000 (0.709") +0.005/+0.030 (mm)	24.000 +0.035/+0.060	30.000 +/-0.127	30.00	3.00	BF0180-0240-0300-BS

 Stocked or Short Delivery

 Usually Available Short Delivery

 Long delivery or not in current production

* Large Minimum Quantities

** Available only while stock last:

Bushes - Flanged

Nominal ID (d) mm (inches)	Nominal OD (D) mm	Length (S) mm	Flange OD (D1) mm	Flange Thickness (S1) mm	Part Number
19.050 (0.750") +0.000/+0.025 (mm)	22.225 +0.025/+0.051	12.700 +/-0.127	25.40	1.59	BF0191-0222-0127-BS2516LT
19.050 (0.750") +0.025/+0.051 (mm)	22.225 +0.051/+0.076	19.050 +/-0.127	28.58	3.97	BF0191-0222-0191-BSTH
19.050 (0.750") +0.000/+0.025 (mm)	22.225 +0.025/+0.051	25.400 +/-0.127	25.40	1.59	BF0191-0222-0254-BS2516LT
19.050 (0.750") +0.025/+0.051 (mm)	22.225 +0.051/+0.076	25.400 +/-0.191	28.58	3.97	BF0191-0222-0254-BS2940TH
19.050 (0.750") +0.051/+0.076 (mm)	23.813 -0.013/+0.012	14.288 +/-0.127	33.34	3.18	BF0191-0238-0143-BS3332HU
19.050 (0.750") +0.051/+0.076 (mm)	23.813 -0.013/+0.012	19.050 +/-0.127	28.58	2.38	BF0191-0238-0191-BS2924HU
19.050 (0.750") -0.013/+0.013 (mm)	23.813 +0.063/+0.089	19.050 +/-0.127	33.34	3.18	BF0191-0238-0191-BS3332UH
19.050 (0.750") +0.025/+0.051 (mm)	23.813 +0.038/+0.063	25.400 +/-0.191	30.16	3.97	BF0191-0238-0254-BS3040TH
19.050 (0.750") +0.025/+0.051 (mm)	23.813 -0.013/+0.013	25.400	30.160	3.97	BF0191-0238-0254-BS3040TU
19.050 (0.750") -0.013/+0.013 (mm)	23.813 +0.063/+0.089	25.400 +/-0.127	33.34	3.18	BF0191-0238-0254-BS3332UH
19.050 (0.750") +0.051/+0.076 (mm)	23.813 +0.051/+0.076	28.575 +/-0.127	29.85	3.18	BF0191-0238-0286-BS3032HH
19.050 (0.750") +0.051/+0.076 (mm)	23.813 -0.013/+0.012	31.750 +/-0.127	33.34	3.18	BF0191-0238-0318-BS3332HU
19.050 (0.750") +0.025/+0.051 (mm)	23.813 +0.038/+0.063	38.100 +/-0.127	30.16	3.97	BF0191-0238-0381-BS3040TH
19.050 (0.750") +0.025/+0.051 (mm)	23.813 -0.013/+0.013	38.100	30.160	3.97	BF0191-0238-0381-BS3040TU
19.050 (0.750") +0.051/+0.076 (mm)	23.813 -0.013/+0.012	39.688 +/-0.190	33.34	3.18	BF0191-0238-0397-BS3332HU
19.050 (0.750") +0.051/+0.076 (mm)	25.400 +0.051/+0.076	12.700 +/-0.127	28.58	3.18	BF0191-0254-0127-BS2932HH
19.050 (0.750") -0.013/+0.013 (mm)	25.400 +0.025/+0.051	12.700 +/-0.127	36.51	3.18	BF0191-0254-0127-BS3732UT
19.050 (0.750") +0.025/+0.051 (mm)	25.400 +0.051/+0.076	15.875 +/-0.127	31.75	3.97	BF0191-0254-0159-BS3240TH
19.050 (0.750") -0.013/+0.013 (mm)	25.400 +0.025/+0.051	15.875 +/-0.127	36.51	3.18	BF0191-0254-0159-BS3732UT
19.050 (0.750") +0.051/+0.076 (mm)	25.400 +0.051/+0.076	19.050 +/-0.127	28.58	3.18	BF0191-0254-0191-BS2932HH
19.050 (0.750") +0.025/+0.051 (mm)	25.400 +0.051/+0.076	19.050 +/-0.191	31.75	3.97	BF0191-0254-0191-BS3240TH
19.050 (0.750") +0.025/+0.051 (mm)	25.400 +0.025/+0.051	19.050 +/-0.127	33.34	3.18	BF0191-0254-0191-BS3332
19.050 (0.750") +0.025/+0.051 (mm)	25.400 +0.035/+0.056	19.050 +/-0.127	34.93	3.18	BF0191-0254-0191-BS3532
19.050 (0.750") +0.000/+0.025 (mm)	25.400 +0.025/+0.051	19.050 +/-0.127	38.10	3.18	BF0191-0254-0191-BS3832LT
19.050 (0.750") +0.102/+0.127 (mm)	25.400 +0.025/+0.051	25.400	24.960	3.10	BF0191-0254-0254-BS2532HT
19.050 (0.750") +0.051/+0.076 (mm)	25.400 +0.051/+0.076	25.400 +/-0.127	28.58	3.18	BF0191-0254-0254-BS2932HH
19.050 (0.750") +0.025/+0.051 (mm)	25.400 +0.051/+0.076	25.400 +/-0.191	31.75	3.97	BF0191-0254-0254-BS3240TH
19.050 (0.750") +0.025/+0.051 (mm)	25.400 +0.025/+0.051	25.400 +/-0.127	33.34	3.18	BF0191-0254-0254-BS3332
19.050 (0.750") +0.025/+0.051 (mm)	25.400 +0.035/+0.056	25.400 +/-0.127	34.93	3.18	** BF0191-0254-0254-BS3532
19.050 (0.750") +0.000/+0.025 (mm)	25.400 +0.025/+0.051	25.400 +/-0.127	38.10	3.18	BF0191-0254-0254-BS3832LT
19.050 (0.750") -0.013/+0.013 (mm)	25.400 +0.025/+0.051	28.575 +/-0.127	36.51	3.18	BF0191-0254-0286-BS3732UT
19.050 (0.750") +0.025/+0.051 (mm)	25.400 +0.051/+0.076	31.750 +/-0.127	31.75	3.97	BF0191-0254-0318-BS3240TH
19.050 (0.750") +0.025/+0.051 (mm)	25.400 +0.035/+0.056	31.750 +/-0.127	34.93	3.18	BF0191-0254-0318-BS3532
19.050 (0.750") +0.000/+0.025 (mm)	25.400 +0.025/+0.051	31.750 +/-0.127	38.10	3.18	BF0191-0254-0318-BS3832LT

Stocked or Short Delivery

Usually Available Short Delivery

Long delivery or not in current production

* Large Minimum Quantities

** Available only while stock last:

Bushes - Flanged

Nominal ID (d) mm (inches)	Nominal OD (D) mm	Length (S) mm	Flange OD (D1) mm	Flange Thickness (S1) mm	Part Number
19.050 (0.750") +0.025/+0.051 (mm)	25.400 +0.051/+0.076	38.100 +/-0.127	31.75	3.97	BF0191-0254-0381-BS3240TH
19.050 (0.750") +0.000/+0.025 (mm)	25.400 +0.025/+0.051	38.100 +/-0.127	38.10	3.18	BF0191-0254-0381-BS3832LT
19.050 (0.750") +0.025/+0.051 (mm)	25.400 +0.051/+0.076	50.800 +/-0.190	31.75	3.97	BF0191-0254-0508-BSTH
19.050 (0.750") +0.025/+0.051 (mm)	26.988 +0.051/+0.076	30.163 +/-0.127	30.16	3.18	BF0191-0270-0302-BS3032TH
20.000 (0.787") +0.005/+0.030 (mm)	24.000 +0.035/+0.060	12.000 +/-0.127	28.00	2.00	BF0200-0240-0120-BSLT
20.000 (0.787") +0.005/+0.030 (mm)	24.000 +0.035/+0.060	16.000 +/-0.120	28.00	2.00	BF0200-0240-0160-BS
20.000 (0.787") +0.005/+0.030 (mm)	24.000 +0.035/+0.060	20.000 +/-0.120	28.00	2.00	BF0200-0240-0200-BS
20.000 (0.787") +0.005/+0.030 (mm)	24.000 +0.035/+0.060	25.000 +/-0.120	28.00	2.00	BF0200-0240-0250-BS
20.000 (0.787") +0.005/+0.030 (mm)	26.000 +0.035/+0.060	15.000 +/-0.127	32.00	3.00	BF0200-0260-0150-BS
20.000 (0.787") +0.005/+0.030 (mm)	26.000 +0.035/+0.060	16.000 +/-0.120	32.00	3.00	BF0200-0260-0160-BS
20.000 (0.787") +0.005/+0.030 (mm)	26.000 +0.035/+0.060	20.000 +/-0.127	32.00	3.00	BF0200-0260-0200-BS
20.000 (0.787") +0.005/+0.030 (mm)	26.000 +0.035/+0.060	25.000 +/-0.127	32.00	3.00	BF0200-0260-0250-BS
20.000 (0.787") +0.005/+0.030 (mm)	26.000 +0.035/+0.060	30.000 +/-0.127	32.00	3.00	BF0200-0260-0300-BS
20.000 (0.787") +0.005/+0.030 (mm)	26.000 +0.035/+0.060	32.000 +/-0.120	32.00	3.00	BF0200-0260-0320-BS
22.000 (0.866") +0.005/+0.030 (mm)	27.000 +0.035/+0.060	18.000 +/-0.120	32.00	2.50	BF0220-0270-0180-BS
22.000 (0.866") +0.005/+0.030 (mm)	27.000 +0.035/+0.060	22.000 +/-0.120	32.00	2.50	BF0220-0270-0220-BS
22.000 (0.866") +0.005/+0.030 (mm)	27.000 +0.035/+0.060	28.000 +/-0.120	32.00	2.50	BF0220-0270-0280-BS
22.000 (0.866") +0.005/+0.030 (mm)	28.000 +0.035/+0.060	15.000 +/-0.127	34.00	3.00	BF0220-0280-0150-BSLT
22.000 (0.866") +0.005/+0.030 (mm)	28.000 +0.035/+0.060	16.000 +/-0.120	34.00	3.00	BF0220-0280-0160-BS
22.000 (0.866") +0.005/+0.030 (mm)	28.000 +0.035/+0.060	20.000 +/-0.120	34.00	3.00	BF0220-0280-0200-BS
22.000 (0.866") +0.005/+0.030 (mm)	28.000 +0.035/+0.060	25.000 +/-0.120	34.00	3.00	BF0220-0280-0250-BS
22.000 (0.866") +0.005/+0.030 (mm)	28.000 +0.035/+0.060	30.000 +/-0.120	34.00	3.00	BF0220-0280-0300-BS
22.000 (0.866") +0.005/+0.030 (mm)	29.000 +0.035/+0.060	18.000 +/-0.120	36.00	3.50	BF0220-0290-0180-BS
22.000 (0.866") +0.005/+0.030 (mm)	29.000 +0.035/+0.060	22.000 +/-0.120	36.00	3.50	BF0220-0290-0220-BS
22.000 (0.866") +0.005/+0.030 (mm)	29.000 +0.035/+0.060	28.000 +/-0.120	36.00	3.50	BF0220-0290-0280-BS
22.000 (0.866") +0.005/+0.030 (mm)	29.000 +0.035/+0.060	36.000 +/-0.120	36.00	3.50	BF0220-0290-0360-BS
22.225 (0.875") +0.012/+0.038 (mm)	25.400 +0.051/+0.076	15.875 +/-0.127	31.75	3.18	BF0222-0254-0159-BS3232LH
22.225 (0.875") +0.025/+0.051 (mm)	25.400 +0.051/+0.076	19.050 +/-0.191	31.75	3.97	BF0222-0254-0191-BS3240TH
22.225 (0.875") +0.013/+0.038 (mm)	25.400 +0.051/+0.076	19.050 +/-0.127	31.750	3.97	BF0222-0254-0191-BS3240LH
22.225 (0.875") +0.025/+0.051 (mm)	25.400 +0.051/+0.076	25.400 +/-0.191	31.75	3.97	BF0222-0254-0254-BS3240TH
22.225 (0.875") +0.013/+0.038 (mm)	25.400 +0.051/+0.076	25.400 +/-0.127	31.750	3.97	BF0222-0254-0254-BS3240LH
22.225 (0.875") +0.025/+0.051 (mm)	25.400 +0.051/+0.076	31.750 +/-0.127	31.75	3.97	BF0222-0254-0318-BS3240TH
22.225 (0.875") +0.025/+0.051 (mm)	28.575 +0.051/+0.076	15.875 +/-0.127	38.10	3.18	BF0222-0286-0159-BS3832TH
22.225 (0.875") +0.025/+0.051 (mm)	28.575 +0.051/+0.076	19.050 +/-0.127	38.10	3.18	BF0222-0286-0191-BS3832TH

Stocked or Short Delivery

Usually Available Short Delivery

Long delivery or not in current production

* Large Minimum Quantities

** Available only while stock last:

Bushes - Flanged

Nominal ID (d) mm (inches)	Nominal OD (D) mm	Length (S) mm	Flange OD (D1) mm	Flange Thickness (S1) mm	Part Number
22.225 (0.875") +0.025/+0.051 (mm)	28.575 +0.035/+0.056	19.050 +/-0.127	41.28	3.18	BF0222-0286-0191-BS4132
22.225 (0.875") +0.025/+0.051 (mm)	28.575 +0.051/+0.076	25.400 +/-0.191	34.93	3.97	BF0222-0286-0254-BS3540TH
22.225 (0.875") +0.025/+0.051 (mm)	28.575 +0.051/+0.076	25.400 +/-0.127	38.10	3.18	BF0222-0286-0254-BS3832TH
22.225 (0.875") +0.025/+0.051 (mm)	28.575 +0.035/+0.056	25.400 +/-0.127	41.28	3.18	BF0222-0286-0254-BS4132
22.225 (0.875") +0.025/+0.051 (mm)	28.575 +0.051/+0.076	31.750 +/-0.127	38.10	3.18	BF0222-0286-0318-BS3832TH
22.225 (0.875") +0.025/+0.051 (mm)	28.575 +0.035/+0.056	31.750 +/-0.127	41.28	3.18	BF0222-0286-0318-BS4132
22.225 (0.875") +0.025/+0.051 (mm)	28.575 +0.051/+0.076	38.100 +/-0.127	34.93	3.97	BF0222-0286-0381-BS3540TH
22.225 (0.875") +0.025/+0.051 (mm)	28.575 +0.035/+0.056	38.100 +/-0.127	41.28	3.18	BF0222-0286-0381-BS4132
22.225 (0.875") +0.025/+0.051 (mm)	28.575 +0.051/+0.076	44.450 +/-0.190	38.10	3.18	BF0222-0286-0445-BS3832TH
25.000 (0.984") +0.005/+0.030 (mm)	30.000 +0.035/+0.060	20.000 +/-0.127	35.00	2.50	BF0250-0300-0200-BS3525
25.000 (0.984") +0.005/+0.030 (mm)	30.000 +0.035/+0.060	20.000 +/-0.127	39.00	3.50	BF0250-0300-0200-BS
25.000 (0.984") +0.005/+0.030 (mm)	30.000 +0.035/+0.060	25.000 +/-0.120	35.00	2.50	BF0250-0300-0250-BS3525
25.000 (0.984") +0.005/+0.030 (mm)	30.000 +0.035/+0.060	25.000 +/-0.127	39.00	3.50	BF0250-0300-0250-BS
25.000 (0.984") +0.005/+0.030 (mm)	30.000 +0.035/+0.060	30.000 +/-0.120	35.00	2.50	BF0250-0300-0300-BS3525
25.000 (0.984") +0.005/+0.030 (mm)	30.000 +0.035/+0.060	32.000 +/-0.120	35.00	2.50	BF0250-0300-0320-BS3525
25.000 (0.984") +0.025/+0.051 (mm)	30.000 +0.035/+0.056	32.000 +/-0.127	39.00	3.50	BF0250-0300-0320-BS
25.000 (0.984") +0.005/+0.030 (mm)	32.000 +0.035/+0.060	20.000 +/-0.120	39.00	3.50	BF0250-0320-0200-BS
25.000 (0.984") +0.005/+0.030 (mm)	32.000 +0.040/+0.070	25.000 +/-0.127	39.00	3.50	BF0250-0320-0250-BS
25.000 (0.984") +0.005/+0.030 (mm)	32.000 +0.040/+0.070	30.000 +/-0.127	39.00	4.00	BF0250-0320-0300-BSLT
25.000 (0.984") +0.005/+0.030 (mm)	32.000 +0.040/+0.070	32.000 +/-0.120	39.00	3.50	BF0250-0320-0320-BS
25.400 (1.000") +0.000/+0.025 (mm)	31.750 +0.025/+0.051	19.050 +/-0.127	38.10	3.18	BF0254-0318-0191-BS3832LT
25.400 (1.000") +0.025/+0.051 (mm)	31.750 +0.051/+0.076	19.050 +/-0.191	38.10	4.76	BF0254-0318-0191-BS3848TH
25.400 (1.000") +0.025/+0.051 (mm)	31.750 +0.025/+0.051	19.050 +/-0.190	41.28	3.18	BF0254-0318-0191-BS4132
25.400 (1.000") +0.000/+0.025 (mm)	31.750 +0.051/+0.076	19.050 +/-0.190	47.63	3.18	BF0254-0318-0191-BS4832LH
25.400 (1.000") +0.025/+0.051 (mm)	31.750 +0.043/+0.068	25.400 +/-0.127	38.10	3.18	BF0254-0318-0254-BS3832TH
25.400 (1.000") +0.025/+0.051 (mm)	31.750 +0.051/+0.076	25.400 +/-0.127	38.10	4.76	BF0254-0318-0254-BS3848TH
25.400 (1.000") +0.000/+0.025 (mm)	31.750 +0.051/+0.076	25.400 +/-0.127	47.63	3.18	BF0254-0318-0254-BS4832LH
25.400 (1.000") +0.025/+0.051 (mm)	31.750 +0.051/+0.076	31.750 +/-0.127	38.10	4.76	BF0254-0318-0318-BS3848TH
25.400 (1.000") +0.025/+0.051 (mm)	31.750 +0.025/+0.051	31.750 +/-0.127	41.28	3.18	BF0254-0318-0318-BS4132
25.400 (1.000") +0.000/+0.025 (mm)	31.750 +0.051/+0.076	31.750 +/-0.127	47.63	3.18	BF0254-0318-0318-BS4832LH
25.400 (1.000") +0.000/+0.025 (mm)	31.750 +0.025/+0.051	38.100 +/-0.127	38.10	3.18	BF0254-0318-0381-BS3832LT
25.400 (1.000") +0.025/+0.051 (mm)	31.750 +0.051/+0.076	38.100 +/-0.127	38.10	3.97	BF0254-0318-0381-BS3840TH
25.400 (1.000") +0.025/+0.051 (mm)	31.750 +0.051/+0.076	38.100 +/-0.127	38.10	4.76	BF0254-0318-0381-BS3848TH
25.400 (1.000") +0.025/+0.051 (mm)	31.750 +0.025/+0.051	38.100 +/-0.127	41.28	3.18	BF0254-0318-0381-BS4132

Stocked or Short Delivery

Usually Available Short Delivery

Long delivery or not in current production

* Large Minimum Quantities

** Available only while stock last:

Bushes - Flanged

Nominal ID (d) mm (inches)	Nominal OD (D) mm	Length (S) mm	Flange OD (D1) mm	Flange Thickness (S1) mm	Part Number
25.400 (1.000") +0.025/+0.051 (mm)	31.750 +0.025/+0.051	44.450 +/-0.190	41.28	3.18	BF0254-0318-0445-BS
25.400 (1.000") +0.025/+0.051 (mm)	31.750 +0.051/+0.076	50.800 +/-0.190	38.10	4.76	BF0254-0318-0508-BS3848TH
25.400 (1.000") +0.000/+0.025 (mm)	33.338 +0.063/+0.089	31.750 +/-0.127	44.45	5.56	BF0254-0333-0318-BS4456LH
25.400 (1.000") +0.000/+0.025 (mm)	33.338 +0.063/+0.089	38.100 +/-0.127	44.45	5.56	BF0254-0333-0381-BS4456LH
25.400 (1.000") +0.012/+0.038 (mm)	33.338 +0.051/+0.076	38.100 +/-0.127	47.63	3.18	BF0254-0333-0381-BS4832LH
25.400 (1.000") +0.025/+0.051 (mm)	34.925 +0.051/+0.076	25.400 +/-0.191	41.28	4.76	BF0254-0349-0254-BSTH
25.400 (1.000") +0.025/+0.051 (mm)	34.925 +0.051/+0.076	44.450 +/-0.190	41.28	4.76	BF0254-0349-0445-BS4148
25.400 (1.000") -0.025/+0.000 (mm)	34.925 +0.063/+0.089	44.450 +/-0.190	44.45	4.76	BF0254-0349-0445-BS4448UH
25.400 (1.000") -0.025/+0.000 (mm)	34.925 +0.063/+0.089	50.800 +/-0.190	44.45	4.76	BF0254-0349-0508-BS4448UH
28.000 (1.102") +0.005/+0.030 (mm)	33.000 +0.040/+0.070	22.000 +/-0.120	38.00	2.50	BF0280-0330-0220-BS
28.000 (1.102") +0.005/+0.030 (mm)	33.000 +0.040/+0.070	28.000 +/-0.120	38.00	2.50	BF0280-0330-0280-BS
28.000 (1.102") +0.005/+0.030 (mm)	33.000 +0.040/+0.070	36.000 +/-0.120	38.00	2.50	BF0280-0330-0360-BS
28.000 (1.102") +0.005/+0.030 (mm)	36.000 +0.040/+0.070	22.000 +/-0.120	44.00	4.00	BF0280-0360-0220-BS
28.000 (1.102") +0.005/+0.030 (mm)	36.000 +0.040/+0.070	28.000 +/-0.120	44.00	4.00	BF0280-0360-0280-BS
28.000 (1.102") +0.005/+0.030 (mm)	36.000 +0.040/+0.070	36.000 +/-0.120	44.00	4.00	BF0280-0360-0360-BS
28.575 (1.125") +0.025/+0.051 (mm)	34.925 +0.025/+0.051	19.050 +/-0.190	44.45	3.18	BF0286-0349-0191-BS
28.575 (1.125") +0.025/+0.051 (mm)	34.925 +0.025/+0.051	25.400 +/-0.127	44.45	3.18	BF0286-0349-0254-BS
28.575 (1.125") +0.025/+0.051 (mm)	34.925 +0.025/+0.051	31.750 +/-0.127	44.45	3.18	BF0286-0349-0318-BS
30.000 (1.181") +0.005/+0.030 (mm)	38.000 +0.040/+0.070	20.000 +/-0.127	46.00	4.00	BF0300-0380-0200-BSTH
30.000 (1.181") +0.005/+0.030 (mm)	38.000 +0.040/+0.070	25.000 +/-0.127	46.00	4.00	BF0300-0380-0250-BSTH
30.000 (1.181") +0.005/+0.030 (mm)	38.000 +0.040/+0.070	30.000 +/-0.127	46.00	4.00	BF0300-0380-0300-BSTH
31.750 (1.250") +0.012/+0.038 (mm)	38.100 +0.051/+0.076	12.700 +/-0.127	42.86	3.18	BF0318-0381-0127-BS4332LH
31.750 (1.250") +0.025/+0.051 (mm)	38.100 +0.051/+0.076	25.400 +/-0.190	44.45	4.76	BF0318-0381-0254-BSTH
31.750 (1.250") +0.012/+0.038 (mm)	38.100 +0.051/+0.076	31.750 +/-0.127	42.86	3.18	BF0318-0381-0318-BS4332LH
31.750 (1.250") +0.025/+0.051 (mm)	38.100 +0.051/+0.076	31.750 +/-0.127	44.45	4.76	BF0318-0381-0318-BS4448
31.750 (1.250") +0.025/+0.051 (mm)	38.100 +0.051/+0.076	38.100 +/-0.127	50.80	2.38	BF0318-0381-0381-BS5124
31.750 (1.250") +0.025/+0.051 (mm)	38.100 +0.051/+0.076	44.450 +/-0.190	50.80	2.38	BF0318-0381-0445-BS5124TH
32.000 (1.260") +0.009/+0.040 (mm)	38.000 +0.040/+0.070	20.000 +/-0.120	44.00	3.00	BF0320-0380-0200-BS
32.000 (1.260") +0.009/+0.040 (mm)	38.000 +0.040/+0.070	25.000 +/-0.127	44.00	3.00	BF0320-0380-0250-BSLT
32.000 (1.260") +0.009/+0.040 (mm)	38.000 +0.040/+0.070	32.000 +/-0.127	44.00	3.00	BF0320-0380-0320-BSLT
32.000 (1.260") +0.009/+0.040 (mm)	40.000 +0.040/+0.070	20.000 +/-0.120	48.00	4.00	BF0320-0400-0200-BS
32.000 (1.260") +0.009/+0.040 (mm)	40.000 +0.040/+0.070	25.000 +/-0.120	48.00	4.00	BF0320-0400-0250-BS
32.000 (1.260") +0.009/+0.040 (mm)	40.000 +0.040/+0.070	30.000 +/-0.120	48.00	4.00	BF0320-0400-0300-BS
32.000 (1.260") +0.009/+0.040 (mm)	40.000 +0.040/+0.070	32.000 +/-0.120	48.00	4.00	BF0320-0400-0320-BS

 Stocked or Short Delivery

 Usually Available Short Delivery

 Long delivery or not in current production

* Large Minimum Quantities

** Available only while stock last:

Bushes - Flanged

Nominal ID (d) mm (inches)	Nominal OD (D) mm	Length (S) mm	Flange OD (D1) mm	Flange Thickness (S1) mm	Part Number
34.925 (1.375") +0.025/+0.051 (mm)	41.275 +0.051/+0.076	19.050 +/-0.190	50.80	3.18	BF0349-0413-0191-BS5132
34.925 (1.375") +0.025/+0.051 (mm)	41.275 +0.051/+0.076	25.400 +/-0.127	50.80	3.18	BF0349-0413-0254-BS5132
35.000 (1.378") +0.025/+0.051 (mm)	45.000 +0.043/+0.068	25.000 +/-0.127	55.00	5.00	BF0350-0450-0250-BS
35.000 (1.378") +0.025/+0.051 (mm)	45.000 +0.043/+0.068	35.000 +/-0.127	55.00	5.00	BF0350-0450-0350-BS
35.000 (1.378") +0.009/+0.040 (mm)	45.000 +0.040/+0.070	40.000 +/-0.190	55.00	5.00	BF0350-0450-0400-BS
36.000 (1.417") +0.009/+0.040 (mm)	42.000 +0.040/+0.070	22.000 +/-0.120	48.00	3.00	BF0360-0420-0220-BS
36.000 (1.417") +0.009/+0.040 (mm)	42.000 +0.040/+0.070	28.000 +/-0.120	48.00	3.00	BF0360-0420-0280-BS
36.000 (1.417") +0.009/+0.040 (mm)	42.000 +0.040/+0.070	36.000 +/-0.120	48.00	3.00	BF0360-0420-0360-BS
36.000 (1.417") +0.009/+0.040 (mm)	45.000 +0.040/+0.070	22.000 +/-0.120	54.00	4.50	BF0360-0450-0220-BS
36.000 (1.417") +0.009/+0.040 (mm)	45.000 +0.040/+0.070	28.000 +/-0.120	54.00	4.50	BF0360-0450-0280-BS
36.000 (1.417") +0.009/+0.040 (mm)	45.000 +0.040/+0.070	36.000 +/-0.120	54.00	4.50	BF0360-0450-0360-BS
38.100 (1.500") +0.051/+0.076 (mm)	44.450 +0.025/+0.051	38.100 +/-0.127	50.80	2.38	BF0381-0445-0381-BS5124HL
38.100 (1.500") +0.051/+0.076 (mm)	44.450 +0.064/+0.102	38.100 +/-0.120	52.400	4.76	BF0381-0445-0381-BS5248HH
40.000 (1.575") +0.009/+0.040 (mm)	46.000 +0.040/+0.070	20.000 +/-0.127	56.00	5.00	BF0400-0460-0200-BSLT
40.000 (1.575") +0.009/+0.040 (mm)	46.000 +0.040/+0.070	25.000 +/-0.120	52.00	3.00	BF0400-0460-0250-BS
40.000 (1.575") +0.009/+0.040 (mm)	46.000 +0.040/+0.070	32.000 +/-0.120	52.00	3.00	BF0400-0460-0320-BS
40.000 (1.575") +0.009/+0.040 (mm)	46.000 +0.040/+0.070	40.000 +/-0.190	52.00	3.00	BF0400-0460-0400-BS
40.000 (1.575") +0.051/+0.076 (mm)	50.000 +0.043/+0.082	25.000 +/-0.127	60.00	5.00	BF0400-0500-0250-BSTH
40.000 (1.575") +0.009/+0.040 (mm)	50.000 +0.040/+0.070	30.000 +/-0.127	60.00	5.00	BF0400-0500-0300-BSTH
40.000 (1.575") +0.009/+0.040 (mm)	50.000 +0.040/+0.070	32.000 +/-0.120	60.00	5.00	BF0400-0500-0320-BS
40.000 (1.575") +0.009/+0.040 (mm)	50.000 +0.040/+0.070	40.000 +/-0.190	60.00	5.00	BF0400-0500-0400-BSLT
40.000 (1.575") +0.009/+0.040 (mm)	50.000 +0.040/+0.070	50.000 +/-0.190	60.00	5.00	BF0400-0500-0500-BSLT
41.275 (1.625") +0.012/+0.038 (mm)	50.800 +0.076/+0.102	50.800 +/-0.190	57.15	4.76	BF0413-0508-0508-BS5748LH
44.450 (1.750") +0.051/+0.076 (mm)	57.150 +0.076/+0.102	63.500 +/-0.190	76.20	6.35	BF0445-0572-0635-BSTH
45.000 (1.772") +0.009/+0.040 (mm)	51.000 +0.050/+0.083	28.000 +/-0.120	57.00	3.00	BF0450-0510-0280-BS
45.000 (1.772") +0.009/+0.040 (mm)	51.000 +0.050/+0.083	36.000 +/-0.120	57.00	3.00	BF0450-0510-0360-BS
45.000 (1.772") +0.009/+0.040 (mm)	51.000 +0.050/+0.083	45.000 +/-0.190	57.00	3.00	BF0450-0510-0450-BS
45.000 (1.772") +0.009/+0.040 (mm)	56.000 +0.050/+0.083	28.000 +/-0.120	67.00	5.50	BF0450-0560-0280-BS
45.000 (1.772") +0.009/+0.040 (mm)	56.000 +0.050/+0.083	36.000 +/-0.120	67.00	5.50	BF0450-0560-0360-BS
45.000 (1.772") +0.009/+0.040 (mm)	56.000 +0.050/+0.083	45.000 +/-0.190	67.00	5.50	BF0450-0560-0450-BS
50.000 (1.969") +0.009/+0.040 (mm)	56.000 +0.050/+0.083	30.000 +/-0.120	62.00	3.00	BF0500-0560-0300-BS
50.000 (1.969") +0.009/+0.040 (mm)	56.000 +0.050/+0.083	32.000 +/-0.120	62.00	3.00	BF0500-0560-0320-BS
50.000 (1.969") +0.009/+0.040 (mm)	56.000 +0.050/+0.083	40.000 +/-0.190	62.00	3.00	BF0500-0560-0400-BS
50.000 (1.969") +0.009/+0.040 (mm)	56.000 +0.050/+0.083	50.000 +/-0.190	62.00	3.00	BF0500-0560-0500-BS

 Stocked or Short Delivery

 Usually Available Short Delivery

 Long delivery or not in current production

* Large Minimum Quantities

** Available only while stock last:

Bushes - Flanged

Nominal ID (d) mm (inches)	Nominal OD (D) mm	Length (S) mm	Flange OD (D1) mm	Flange Thickness (S1) mm	Part Number
50.000 (1.969") +0.009/+0.040 (mm)	60.000 +0.050/+0.083	32.000 +/-0.127	70.00	5.00	BF0500-0600-0320-BSTH
50.000 (1.969") +0.009/+0.040 (mm)	60.000 +0.050/+0.083	35.000 +/-0.120	70.00	5.00	BF0500-0600-0350-BS
50.000 (1.969") +0.009/+0.040 (mm)	60.000 +0.050/+0.083	40.000 +/-0.190	70.00	5.00	BF0500-0600-0400-BSTH
50.000 (1.969") +0.009/+0.040 (mm)	60.000 +0.040/+0.070	50.000 +/-0.190	70.00	5.00	BF0500-0600-0500-BSLT
50.800 (2.000") +0.051/+0.076 (mm)	57.150 +0.076/+0.102	19.050 +/-0.190	63.50	3.18	BF0508-0572-0191-BS6432TH
50.800 (2.000") +0.051/+0.076 (mm)	57.150 +0.076/+0.102	25.400 +/-0.127	63.50	3.18	BF0508-0572-0254-BS6432TH
50.800 (2.000") +0.051/+0.076 (mm)	57.150 +0.076/+0.102	31.750 +/-0.127	63.50	3.18	BF0508-0572-0318-BS6432TH
50.800 (2.000") +0.025/+0.051 (mm)	63.500 +0.000/+0.025	60.325 +/-0.190	76.20	9.53	BF0508-0635-0603-BS7695LL
60.000 (2.362") +0.010/+0.040 (mm)	70.000 +0.050/+0.083	50.000 +/-0.190	80.00	5.00	BF0600-0700-0500-BS
60.000 (2.362") +0.010/+0.040 (mm)	70.000 +0.050/+0.083	60.000 +/-0.250	80.00	5.00	BF0600-0700-0600-BS
69.850 (2.750") +0.025/+0.051 (mm)	82.550 -0.025/+0.000	38.100 +/-0.127	101.60	4.76	BF0699-0826-0381-BS10248LU
76.200 (3.000") +0.025/+0.051 (mm)	88.900 +0.025/+0.051	60.325 +/-0.190	101.60	9.53	BF0762-0889-0603-BSLL

Bushes - Plain

Nominal ID (d) mm (inches)	Nominal OD (D) mm	Length (S) mm	Part Number
1.191 (0.047") +0.000/+0.010 (mm)	3.969 -0.010/+0.003	1.588 +0/-0.127	BP0012-0040-0016-BSLU
1.191 (0.047") +0.000/+0.010 (mm)	3.969 -0.010/+0.003	2.380 +0/-0.127	BP0012-0040-0024-BSLU
1.191 (0.047") +0.000/+0.010 (mm)	4.763 -0.010/+0.003	1.984 +0/-0.127	BP0012-0048-0020-BSLU
1.191 (0.047") +0.000/+0.010 (mm)	4.763 -0.010/+0.003	2.779 +0/-0.127	BP0012-0048-0028-BSLU
1.588 (0.063") +0.000/+0.010 (mm)	4.763 -0.010/+0.003	2.380 +0/-0.127	BP0016-0048-0024-BSLU
1.588 (0.063") +0.000/+0.010 (mm)	6.350 -0.010/+0.003	2.380 +0/-0.127	BP0016-0064-0024-BSLU
1.984 (0.078") +0.000/+0.010 (mm)	6.350 -0.010/+0.003	2.380 +0/-0.127	BP0019-0064-0024-BSLU
1.984 (0.078") +0.000/+0.010 (mm)	6.350 -0.010/+0.003	3.571 +0/-0.127	BP0019-0064-0036-BSLU
2.000 (0.079") +0.014/+0.024 (mm)	4.000 +0.015/+0.027	3.000 +0/-0.200	BP0020-0040-0030-BSLL
2.000 (0.079") +0.014/+0.024 (mm)	4.000 +0.015/+0.027	4.000 +0/-0.200	BP0020-0040-0040-BSLL
2.000 (0.079") +0.014/+0.024 (mm)	5.000 +0.019/+0.031	2.000 +/-0.127	BP0020-0050-0020-BSLL
2.000 (0.079") +0.000/+0.024 (mm)	5.000 +0.019/+0.040	3.000 +0/-0.200	BP0020-0050-0030-BSLL
2.381 (0.094") +0.000/+0.010 (mm)	4.763 -0.010/+0.003	1.588 +0/-0.127	BP0024-0048-0016-BSLU
2.381 (0.094") +0.000/+0.010 (mm)	4.763 -0.010/+0.003	2.380 +0/-0.127	BP0024-0048-0024-BSLU
2.381 (0.094") +0.000/+0.010 (mm)	6.350 -0.010/+0.003	1.588 +0/-0.127	BP0024-0064-0016-BSLU
2.381 (0.094") +0.000/+0.010 (mm)	7.938 -0.010/+0.003	2.779 +0/-0.127	BP0024-0079-0028-BSLU
2.381 (0.094") +0.000/+0.010 (mm)	7.938 -0.010/+0.003	3.571 +0/-0.127	BP0024-0079-0036-BSLU
3.000 (0.118") +0.014/+0.024 (mm)	5.000 +0.015/+0.027	3.000 +0/-0.200	BP0030-0050-0030-BSLL
3.000 (0.118") +0.014/+0.024 (mm)	5.000 +0.015/+0.027	4.000 +0/-0.200	BP0030-0050-0040-BSLL
3.000 (0.118") +0.014/+0.024 (mm)	5.000 +0.015/+0.027	6.000 +0/-0.200	BP0030-0050-0060-BSLL

Stocked or Short Delivery

Usually Available Short Delivery

Long delivery or not in current production

* Large Minimum Quantities

** Available only while stock last:

Bushes - Plain

Nominal ID (d) mm (inches)	Nominal OD (D) mm	Length (S) mm	Part Number
3.000 (0.118") +0.000/+0.010 (mm)	6.000 -0.008/+0.000	2.500 +0/-0.170	BP0030-0060-0025-BSLU
3.000 (0.118") +0.014/+0.024 (mm)	6.000 +0.025/+0.051	3.000 +/-0.127	BP0030-0060-0030-BSLT
3.000 (0.118") +0.000/+0.024 (mm)	6.000 +0.019/+0.040	4.000 +/-0.127	BP0030-0060-0040-BSLL
3.000 (0.118") +0.000/+0.020 (mm)	6.000 +0.019/+0.040	5.000 +/-0.120	BP0030-0060-0050-BS
3.000 (0.118") +0.000/+0.020 (mm)	6.000 +0.019/+0.040	6.000 +/-0.120	BP0030-0060-0060-BS
3.000 (0.118") +0.000/+0.020 (mm)	6.000 +0.019/+0.040	10.000 +/-0.120	BP0030-0060-0100-BS
3.000 (0.118") +0.000/+0.010 (mm)	8.000 -0.009/+0.000	3.000 +0/-0.170	BP0030-0080-0030-BSLU
3.000 (0.118") +0.000/+0.010 (mm)	10.000 -0.009/+0.000	4.000 +0/-0.170	BP0030-0100-0040-BSLU
3.175 (0.125") +0.038/+0.064 (mm)	4.763 +0.051/+0.076	3.175 +/-0.127	BP0032-0048-0032-BSHH
3.175 (0.125") +0.013/+0.038 (mm)	4.763 +0.025/+0.051	3.175	BP0032-0048-0032-BSLT
3.175 (0.125") -0.025/+0.000 (mm)	4.763 +0.025/+0.051	4.001 +/-0.127	BP0032-0048-0040-BSUT
3.175 (0.125") +0.038/+0.064 (mm)	4.763 +0.051/+0.076	6.350 +/-0.127	BP0032-0048-0064-BSHH
3.175 (0.125") +0.012/+0.038 (mm)	4.763 +0.038/+0.063	6.350 +/-0.127	BP0032-0048-0064-BSLH
3.175 (0.125") -0.025/+0.000 (mm)	4.763 +0.025/+0.051	6.350 +/-0.127	BP0032-0048-0064-BSUT
3.175 (0.125") +0.012/+0.038 (mm)	4.763 +0.038/+0.063	7.938 +/-0.127	BP0032-0048-0079-BSLH
3.175 (0.125") -0.025/+0.000 (mm)	4.763 +0.025/+0.051	9.525 +/-0.127	BP0032-0048-0095-BSUT
3.175 (0.125") -0.025/+0.000 (mm)	4.763 +0.025/+0.051	12.700 +/-0.127	BP0032-0048-0127-BSUT
3.175 (0.125") +0.025/+0.051 (mm)	5.556 +0.057/+0.083	6.350 +/-0.127	BP0032-0056-0064-BSTH
3.175 (0.125") +0.025/+0.051 (mm)	5.556 +0.057/+0.083	9.525 +/-0.127	BP0032-0056-0095-BSTH
3.175 (0.125") +0.000/+0.010 (mm)	6.350 -0.010/+0.003	2.380 +0/-0.127	BP0032-0064-0024-BSLU
3.175 (0.125") +0.000/+0.010 (mm)	6.350 -0.010/+0.003	2.779 +0/-0.127	BP0032-0064-0028-BSLU
3.175 (0.125") +0.025/+0.051 (mm)	6.350 +0.051/+0.076	3.175 +/-0.127	BP0032-0064-0032-BSTH
3.175 (0.125") +0.025/+0.051 (mm)	6.350 +0.025/+0.051	6.350 +/-0.127	BP0032-0064-0064-BS
3.175 (0.125") +0.051/+0.076 (mm)	6.350 +0.051/+0.076	6.350 +/-0.127	BP0032-0064-0064-BSHH
3.175 (0.125") +0.025/+0.051 (mm)	6.350 +0.051/+0.076	6.350 +/-0.127	BP0032-0064-0064-BSTH
3.175 (0.125") +0.051/+0.076 (mm)	6.350 +0.051/+0.076	9.525	BP0032-0064-0095-BSHH
3.175 (0.125") +0.025/+0.051 (mm)	6.350 +0.051/+0.076	9.525 +/-0.127	BP0032-0064-0095-BSTH
3.175 (0.125") +0.038/+0.063 (mm)	6.350 +0.051/+0.076	10.516 +0/-0.102	BP0032-0064-0105-BSHH
3.175 (0.125") +0.000/+0.010 (mm)	7.938 -0.010/+0.003	2.781 +0/-0.127	BP0032-0079-0028-BSLU
3.175 (0.125") +0.000/+0.010 (mm)	7.938 -0.010/+0.003	3.571 +0/-0.127	BP0032-0079-0036-BSLU
3.175 (0.125") +0.000/+0.010 (mm)	9.525 -0.010/+0.003	2.779 +0/-0.127	BP0032-0095-0028-BSLU
3.175 (0.125") +0.000/+0.010 (mm)	9.525 -0.010/+0.003	3.571 +0/-0.127	BP0032-0095-0036-BSLU
3.175 (0.125") +0.025/+0.051 (mm)	9.525 +0.025/+0.051	6.350 +/-0.127	BP0032-0095-0064-BS
3.175 (0.125") +0.025/+0.051 (mm)	9.525 +0.025/+0.051	12.700 +/-0.127	BP0032-0095-0127-BS

Stocked or Short Delivery

Usually Available Short Delivery

Long delivery or not in current production

* Large Minimum Quantities

** Available only while stock last:

Bushes - Plain

Nominal ID (d) mm (inches)	Nominal OD (D) mm	Length (S) mm	Part Number
3.967 (0.156") -0.030/-0.005 (mm)	5.556 +0.006/+0.032	6.350 +/-0.127	BP0040-0056-0064-BSUL
3.967 (0.156") -0.030/-0.005 (mm)	5.556 +0.006/+0.032	9.525 +/-0.127	BP0040-0056-0095-BSUL
3.967 (0.156") +0.046/+0.072 (mm)	6.350 +0.051/+0.076	7.938 +/-0.127	BP0040-0064-0079-BSHH
3.969 (0.156") +0.019/+0.044 (mm)	6.350 +0.051/+0.076	3.175 +/-0.127	BP0039-0064-0032-BSLH
3.969 (0.156") +0.019/+0.044 (mm)	6.350 +0.051/+0.076	4.750 +/-0.127	BP0039-0064-0048-BSLH
3.969 (0.156") +0.019/+0.044 (mm)	6.350 +0.051/+0.076	6.731 +/-0.127	BP0039-0064-0067-BSLH
3.969 (0.156") +0.000/+0.010 (mm)	7.938 -0.010/+0.003	2.779 +0/-0.127	BP0039-0079-0028-BSLU
3.969 (0.156") +0.000/+0.010 (mm)	7.938 -0.010/+0.003	3.175 +0/-0.127	BP0039-0079-0032-BSLU
3.975 (0.156") -0.025/+0.000 (mm)	6.350 +0.038/+0.063	9.525 +/-0.127	BP0040-0064-0095-BSUH
4.000 (0.157") +0.000/+0.020 (mm)	6.000 +0.019/+0.040	8.000 +/-0.120	BP0040-0060-0080-BS
4.000 (0.157") +0.000/+0.020 (mm)	6.000 +0.019/+0.040	10.000 +/-0.120	BP0040-0060-0100-BS
4.000 (0.157") +0.000/+0.020 (mm)	6.000 +0.019/+0.040	17.000 +/-0.120	BP0040-0060-0170-BS
4.000 (0.157") +0.000/+0.020 (mm)	7.000 +0.019/+0.040	4.000 +/-0.127	BP0040-0070-0040-BS
4.000 (0.157") +0.020/+0.032 (mm)	7.000 +0.023/+0.038	6.000 +/-0.127	BP0040-0070-0060-BS
4.000 (0.157") +0.000/+0.020 (mm)	7.000 +0.019/+0.040	8.000 +/-0.120	BP0040-0070-0080-BS
4.000 (0.157") +0.000/+0.020 (mm)	7.000 +0.019/+0.040	10.000 +/-0.120	BP0040-0070-0100-BS
4.000 (0.157") +0.000/+0.020 (mm)	7.000 +0.019/+0.040	12.000 +/-0.120	BP0040-0070-0120-BS
4.000 (0.157") +0.000/+0.012 (mm)	8.000 -0.009/+0.000	4.000 +0/-0.200	BP0040-0080-0040-BSLU
4.000 (0.157") +0.000/+0.032 (mm)	8.000 +0.019/+0.040	4.000 +0/-0.200	BP0040-0080-0040-BSTL
4.000 (0.157") +0.000/+0.032 (mm)	8.000 +0.019/+0.040	6.000 +0/-0.200	BP0040-0080-0060-BSTL
4.000 (0.157") +0.000/+0.032 (mm)	8.000 +0.019/+0.040	8.000 +0/-0.200	BP0040-0080-0080-BSTL
4.000 (0.157") +0.000/+0.020 (mm)	8.000 +0.019/+0.040	10.000 +/-0.120	BP0040-0080-0100-BS
4.000 (0.157") +0.000/+0.020 (mm)	8.000 +0.019/+0.040	12.000 +/-0.120	BP0040-0080-0120-BS
4.763 (0.188") +0.012/+0.038 (mm)	6.350 +0.051/+0.076	4.750 +/-0.127	BP0048-0064-0048-BSLH
4.763 (0.188") +0.012/+0.038 (mm)	6.350 +0.051/+0.076	5.334 +/-0.127	BP0048-0064-0053-BSLH
4.763 (0.188") +0.012/+0.038 (mm)	6.350 +0.051/+0.076	6.172 +/-0.127	BP0048-0064-0062-BSLH
4.763 (0.188") -0.025/+0.000 (mm)	6.350 +0.025/+0.051	6.350 +/-0.127	BP0048-0064-0064-BSUT
4.763 (0.188") +0.000/+0.025 (mm)	6.350 +0.025/+0.051	6.350 +/-0.127	BP0048-0064-0064-BSLT
4.763 (0.188") +0.025/+0.051 (mm)	6.350 +0.051/+0.076	6.350 +/-0.127	BP0048-0064-0064-BSTH
4.763 (0.188") +0.012/+0.038 (mm)	6.350 +0.051/+0.076	7.747 +/-0.127	BP0048-0064-0077-BSLH
4.763 (0.188") -0.025/+0.000 (mm)	6.350 +0.025/+0.051	7.938 +/-0.127	BP0048-0064-0079-BSUT
4.763 (0.188") +0.012/+0.038 (mm)	6.350 +0.051/+0.076	8.382 +/-0.127	BP0048-0064-0084-BSLH
4.763 (0.188") +0.012/+0.038 (mm)	6.350 +0.051/+0.076	8.712 +0/-0.152	BP0048-0064-0087-BSLH
4.763 (0.188") +0.000/+0.025 (mm)	6.350 +0.025/+0.051	9.525 +/-0.127	BP0048-0064-0095-BSLT

Stocked or Short Delivery

Usually Available Short Delivery

Long delivery or not in current production

* Large Minimum Quantities

** Available only while stock last:

Bushes - Plain

Nominal ID (d) mm (inches)	Nominal OD (D) mm	Length (S) mm	Part Number
4.763 (0.188") +0.025/+0.051 (mm)	6.350 +0.051/+0.076	9.525 +/-0.127	BP0048-0064-0095-BSTH
4.763 (0.188") -0.025/+0.000 (mm)	6.350 +0.025/+0.051	9.525 +/-0.127	BP0048-0064-0095-BSUT
4.763 (0.188") +0.012/+0.038 (mm)	6.350 +0.051/+0.076	10.312 +/-0.127	BP0048-0064-0103-BSLH
4.763 (0.188") +0.000/+0.025 (mm)	6.350 +0.025/+0.051	11.113 +/-0.127	BP0048-0064-0111-BSLT
4.763 (0.188") +0.012/+0.038 (mm)	6.350 +0.051/+0.076	11.887 +/-0.127	BP0048-0064-0119-BSLH
4.763 (0.188") +0.025/+0.051 (mm)	6.350 +0.051/+0.076	12.700 +/-0.127	BP0048-0064-0127-BSTH
4.763 (0.188") -0.025/+0.000 (mm)	6.350 +0.025/+0.051	12.700 +/-0.127	BP0048-0064-0127-BSUT
4.763 (0.188") +0.000/+0.025 (mm)	6.350 +0.025/+0.051	12.700 +/-0.127	BP0048-0064-0127-BSLT
4.763 (0.188") +0.000/+0.025 (mm)	6.350 +0.025/+0.051	15.875 +/-0.127	BP0048-0064-0159-BSLT
4.763 (0.188") -0.025/+0.000 (mm)	6.350 +0.025/+0.051	15.875 +/-0.127	BP0048-0064-0159-BSUT
4.763 (0.188") +0.012/+0.038 (mm)	7.144 +0.044/+0.070	4.724 +0/-0.102	BP0048-0071-0047-BSLH
4.763 (0.188") +0.025/+0.051 (mm)	7.938 +0.025/+0.051	4.763 +/-0.127	BP0048-0079-0048-BS
4.763 (0.188") +0.000/+0.025 (mm)	7.938 +0.025/+0.051	4.763 +/-0.127	BP0048-0079-0048-BSLT
4.763 (0.188") +0.012/+0.038 (mm)	7.938 +0.051/+0.076	6.325 +0/-0.102	BP0048-0079-0064-BSLH
4.763 (0.188") +0.025/+0.051 (mm)	7.938 +0.051/+0.076	6.350 +/-0.127	BP0048-0079-0064-BSTH
4.763 (0.188") +0.000/+0.025 (mm)	7.938 +0.025/+0.051	6.350 +/-0.127	BP0048-0079-0064-BSLT
4.763 (0.188") +0.025/+0.051 (mm)	7.938 +0.025/+0.051	6.350 +/-0.127	BP0048-0079-0064-BS
4.763 (0.188") +0.000/+0.025 (mm)	7.938 +0.025/+0.051	7.938 +/-0.127	BP0048-0079-0079-BSLT
4.763 (0.188") +0.025/+0.051 (mm)	7.938 +0.025/+0.051	9.525 +/-0.127	BP0048-0079-0095-BS
4.763 (0.188") +0.000/+0.025 (mm)	7.938 +0.025/+0.051	9.525 +/-0.127	BP0048-0079-0095-BSLT
4.763 (0.188") +0.025/+0.051 (mm)	7.938 +0.051/+0.076	9.525 +/-0.127	BP0048-0079-0095-BSTH
4.763 (0.188") +0.000/+0.025 (mm)	7.938 +0.025/+0.051	11.113 +/-0.127	BP0048-0079-0111-BSLT
4.763 (0.188") +0.025/+0.051 (mm)	7.938 +0.051/+0.076	12.700 +/-0.127	BP0048-0079-0127-BSTH
4.763 (0.188") +0.025/+0.051 (mm)	7.938 +0.025/+0.051	12.700 +/-0.127	BP0048-0079-0127-BS
4.763 (0.188") +0.000/+0.025 (mm)	7.938 +0.025/+0.051	12.700 +/-0.127	BP0048-0079-0127-BSLT
4.763 (0.188") +0.025/+0.051 (mm)	7.938 +0.025/+0.051	15.875 +/-0.127	BP0048-0079-0159-BS
4.763 (0.188") +0.000/+0.025 (mm)	7.938 +0.025/+0.051	15.875 +/-0.127	BP0048-0079-0159-BSLT
4.763 (0.188") +0.000/+0.025 (mm)	7.938 +0.025/+0.051	19.050 +/-0.127	BP0048-0079-0191-BSLT
4.763 (0.188") +0.000/+0.010 (mm)	9.525 -0.010/+0.003	3.175 +0/-0.127	BP0048-0095-0032-BSLU
4.763 (0.188") +0.000/+0.025 (mm)	9.525 +0.038/+0.063	6.350 +/-0.127	BP0048-0095-0064-BSLH
4.763 (0.188") +0.000/+0.025 (mm)	9.525 +0.038/+0.063	9.525 +/-0.127	BP0048-0095-0095-BSLH
4.763 (0.188") +0.000/+0.025 (mm)	9.525 +0.038/+0.063	12.700 +/-0.127	BP0048-0095-0127-BSLH
4.763 (0.188") +0.012/+0.038 (mm)	11.113 +0.051/+0.076	12.700 +/-0.127	BP0048-0111-0127-BSLH
4.763 (0.188") +0.000/+0.010 (mm)	12.700 -0.010/+0.003	3.967 +0/-0.127	BP0048-0127-0040-BSLU

Stocked or Short Delivery

Usually Available Short Delivery

Long delivery or not in current production

* Large Minimum Quantities

** Available only while stock last:

Bushes - Plain

Nominal ID (d) mm (inches)	Nominal OD (D) mm	Length (S) mm	Part Number
4.763 (0.188") +0.000/+0.010 (mm)	12.700 -0.010/+0.003	4.978 +0/-0.127	BP0048-0127-0050-BSLU
5.000 (0.197") +0.000/+0.020 (mm)	7.000 +0.019/+0.040	7.000 +/-0.120	BP0050-0070-0070-BS
5.000 (0.197") +0.000/+0.032 (mm)	8.000 +0.019/+0.040	5.000 +0/-0.200	BP0050-0080-0050-BSTL
5.000 (0.197") +0.000/+0.032 (mm)	8.000 +0.019/+0.040	8.000 +0/-0.200	BP0050-0080-0080-BSTL
5.000 (0.197") +0.000/+0.020 (mm)	8.000 +0.019/+0.040	10.000 +/-0.127	BP0050-0080-0100-BS
5.000 (0.197") +0.000/+0.020 (mm)	8.000 +0.019/+0.040	12.000 +/-0.127	BP0050-0080-0120-BS
5.000 (0.197") +0.000/+0.020 (mm)	8.000 +0.019/+0.040	15.000 +/-0.120	BP0050-0080-0150-BS
5.000 (0.197") +0.000/+0.020 (mm)	8.000 +0.019/+0.040	16.000 +/-0.127	BP0050-0080-0160-BS
5.000 (0.197") +0.000/+0.020 (mm)	9.000 +0.019/+0.040	4.000 +/-0.120	BP0050-0090-0040-BS
5.000 (0.197") +0.000/+0.020 (mm)	9.000 +0.019/+0.040	5.000 +/-0.127	BP0050-0090-0050-BS
5.000 (0.197") +0.000/+0.020 (mm)	9.000 +0.019/+0.040	8.000 +/-0.127	BP0050-0090-0080-BS
5.000 (0.197") +0.000/+0.012 (mm)	10.000 -0.009/+0.000	5.000 +0/-0.170	BP0050-0100-0050-BSLU
5.000 (0.197") +0.000/+0.012 (mm)	12.000 -0.011/+0.000	4.000 +0/-0.170	BP0050-0120-0040-BSLU
5.000 (0.197") +0.000/+0.012 (mm)	13.000 -0.011/+0.000	5.000 +0/-0.170	BP0050-0130-0050-BSLU
5.563 (0.219") -0.025/+0.000 (mm)	7.938 +0.025/+0.051	7.938 +/-0.127	BP0056-0079-0079-BSUT
5.563 (0.219") -0.025/+0.000 (mm)	7.938 +0.025/+0.051	9.525 +/-0.127	BP0056-0079-0095-BSUT
5.563 (0.219") -0.025/+0.000 (mm)	11.113 +0.038/+0.063	12.700 +/-0.127	BP0056-0111-0127-BSUH
5.563 (0.219") -0.025/+0.000 (mm)	11.113 +0.038/+0.063	19.050 +/-0.127	BP0056-0111-0191-BSUH
6.000 (0.236") +0.000/+0.020 (mm)	9.000 +0.019/+0.040	4.000 +/-0.127	BP0060-0090-0040-BS
6.000 (0.236") +0.000/+0.020 (mm)	9.000 +0.019/+0.040	6.000 +/-0.127	BP0060-0090-0060-BS
6.000 (0.236") +0.000/+0.020 (mm)	9.000 +0.019/+0.040	8.000 +/-0.120	BP0060-0090-0080-BS
6.000 (0.236") +0.000/+0.020 (mm)	9.000 +0.019/+0.040	10.000 +/-0.127	BP0060-0090-0100-BS
6.000 (0.236") +0.000/+0.025 (mm)	9.000 +0.019/+0.040	12.000 +/-0.127	BP0060-0090-0120-LT
6.000 (0.236") +0.000/+0.020 (mm)	9.000 +0.019/+0.040	15.000 +/-0.120	BP0060-0090-0150-BS
6.000 (0.236") +0.000/+0.020 (mm)	9.000 +0.019/+0.040	16.000 +/-0.127	BP0060-0090-0160-BS
6.000 (0.236") +0.013/+0.038 (mm)	9.525 +0.051/+0.076	6.350 +/-0.127	BP0060-0095-0064-BSLH
6.000 (0.236") +0.005/+0.030 (mm)	10.000 +0.019/+0.040	4.000 +/-0.127	BP0060-0100-0040-BSLT
6.000 (0.236") +0.000/+0.012 (mm)	10.000 -0.009/+0.000	5.000 +0/-0.170	BP0060-0100-0050-BSLU
6.000 (0.236") +0.000/+0.032 (mm)	10.000 +0.019/+0.040	6.000 +0/-0.200	BP0060-0100-0060-BSTL
6.000 (0.236") +0.000/+0.032 (mm)	10.000 +0.019/+0.040	10.000 +0/-0.200	BP0060-0100-0100-BSTL
6.000 (0.236") +0.000/+0.020 (mm)	10.000 +0.019/+0.040	12.000 +/-0.120	BP0060-0100-0120-BS
6.000 (0.236") +0.000/+0.020 (mm)	10.000 +0.019/+0.040	14.000 +/-0.120	BP0060-0100-0140-BS
6.000 (0.236") +0.000/+0.020 (mm)	10.000 +0.019/+0.040	16.000 +/-0.120	BP0060-0100-0160-BS
6.000 (0.236") +0.000/+0.020 (mm)	12.000 +0.028/+0.050	6.000 +/-0.120	BP0060-0120-0060-BS

 Stocked or Short Delivery

 Usually Available Short Delivery

 Long delivery or not in current production

* Large Minimum Quantities

** Available only while stock last:

Bushes - Plain

Nominal ID (d) mm (inches)	Nominal OD (D) mm	Length (S) mm	Part Number
6.000 (0.236") +0.000/+0.032 (mm)	12.000 +0.028/+0.050	8.000 +0/-0.200	BP0060-0120-0080-BS
6.000 (0.236") +0.000/+0.020 (mm)	12.000 +0.028/+0.050	10.000 +/-0.120	BP0060-0120-0100-BS
6.000 (0.236") +0.000/+0.020 (mm)	12.000 +0.028/+0.050	11.000 +/-0.120	BP0060-0120-0110-BS
6.000 (0.236") +0.020/+0.032 (mm)	12.000 +0.028/+0.050	12.000 +0/-0.200	BP0060-0120-0120-BS
6.000 (0.236") +0.000/+0.020 (mm)	12.000 +0.028/+0.050	15.000 +/-0.120	BP0060-0120-0150-BS
6.000 (0.236") +0.000/+0.020 (mm)	12.000 +0.028/+0.050	16.000 +/-0.120	BP0060-0120-0160-BS
6.000 (0.236") +0.000/+0.020 (mm)	12.000 +0.028/+0.050	25.000 +/-0.120	BP0060-0120-0250-BS
6.000 (0.236") +0.000/+0.012 (mm)	16.000 -0.011/+0.000	5.000 +0/-0.170	BP0060-0160-0050-BSLU
6.350 (0.250") +0.025/+0.051 (mm)	7.938 +0.051/+0.076	2.921 +/-0.127	BP0064-0079-0029-BSTH
6.350 (0.250") +0.025/+0.051 (mm)	7.938 +0.051/+0.076	4.293 +0/-0.152	BP0064-0079-0043-BSTH
6.350 (0.250") +0.025/+0.051 (mm)	7.938 +0.051/+0.076	4.750 +/-0.127	BP0064-0079-0048-BSTH
6.350 (0.250") +0.025/+0.051 (mm)	7.938 +0.051/+0.076	5.944 +/-0.127	BP0064-0079-0059-BSTH
6.350 (0.250") -0.013/+0.013 (mm)	7.938 +0.025/+0.051	6.350 +/-0.127	BP0064-0079-0064-BSUT
6.350 (0.250") +0.012/+0.038 (mm)	7.938 +0.051/+0.076	6.350 +/-0.127	BP0064-0079-0064-BSLH
6.350 (0.250") +0.025/+0.051 (mm)	7.938 +0.051/+0.076	6.350 +/-0.127	BP0064-0079-0064-BSTH
6.350 (0.250") +0.025/+0.051 (mm)	7.938 +0.051/+0.076	8.839 +/-0.127	BP0064-0079-0088-BSTH
6.350 (0.250") +0.012/+0.038 (mm)	7.938 +0.051/+0.076	9.525 +/-0.127	BP0064-0079-0095-BSLH
6.350 (0.250") +0.025/+0.051 (mm)	7.938 +0.051/+0.076	9.906 +/-0.127	BP0064-0079-0099-BSTH
6.350 (0.250") +0.025/+0.051 (mm)	7.938 +0.051/+0.076	11.100 +/-0.127	BP0064-0079-0111-BSTH
6.350 (0.250") +0.051/+0.076 (mm)	7.938 +0.051/+0.076	12.700	BP0064-0079-0127-BSHH
6.350 (0.250") +0.025/+0.051 (mm)	7.938 +0.051/+0.076	12.700 +/-0.127	BP0064-0079-0127-BSTH
6.350 (0.250") -0.013/+0.013 (mm)	7.938 +0.025/+0.051	12.700	BP0064-0079-0127-BSUT
6.350 (0.250") +0.051/+0.076 (mm)	7.938 +0.051/+0.076	15.875 +/-0.127	BP0064-0079-0159-BSHH
6.350 (0.250") +0.025/+0.051 (mm)	7.938 +0.051/+0.076	19.050 +/-0.127	BP0064-0079-0191-BSTH
6.350 (0.250") +0.051/+0.076 (mm)	7.938 +0.051/+0.076	19.050	BP0064-0079-0191-BSHH
6.350 (0.250") +0.000/+0.010 (mm)	9.525 -0.010/+0.003	3.175 +0/-0.127	BP0064-0095-0032-BSLU
6.350 (0.250") +0.025/+0.051 (mm)	9.525 +0.051/+0.076	5.537 +/-0.127	BP0064-0095-0055-BSTH
6.350 (0.250") +0.025/+0.051 (mm)	9.525 +0.025/+0.051	6.350	BP0064-0095-0064-BS
6.350 (0.250") +0.051/+0.076 (mm)	9.525 +0.025/+0.051	6.350 +/-0.127	BP0064-0095-0064-BSHT
6.350 (0.250") +0.025/+0.051 (mm)	9.525 +0.051/+0.076	6.350 +/-0.127	BP0064-0095-0064-BSTH
6.350 (0.250") -0.013/+0.013 (mm)	9.525 +0.025/+0.051	6.350 +/-0.127	BP0064-0095-0064-BSUT
6.350 (0.250") +0.025/+0.051 (mm)	9.525 +0.051/+0.076	7.518 +/-0.127	BP0064-0095-0075-BSTH
6.350 (0.250") +0.025/+0.051 (mm)	9.525 +0.025/+0.051	7.938	BP0064-0095-0079-BS
6.350 (0.250") +0.025/+0.051 (mm)	9.525 +0.051/+0.076	7.938 +/-0.127	BP0064-0095-0079-BSTH

Stocked or Short Delivery

Usually Available Short Delivery

Long delivery or not in current production

* Large Minimum Quantities

** Available only while stock last:

Bushes - Plain

Nominal ID (d) mm (inches)	Nominal OD (D) mm	Length (S) mm	Part Number
6.350 (0.250") -0.013/+0.013 (mm)	9.525 +0.025/+0.051	7.938 +/-0.127	BP0064-0095-0079-BSUT
6.350 (0.250") +0.025/+0.051 (mm)	9.525 +0.025/+0.051	9.525	BP0064-0095-0095-BS
6.350 (0.250") +0.025/+0.051 (mm)	9.525 +0.051/+0.076	9.525 +/-0.127	BP0064-0095-0095-BSTH
6.350 (0.250") -0.013/+0.013 (mm)	9.525 +0.025/+0.051	9.525 +/-0.127	BP0064-0095-0095-BSUT
6.350 (0.250") +0.025/+0.051 (mm)	9.525 +0.051/+0.076	10.312 +/-0.127	BP0064-0095-0103-BSTH
6.350 (0.250") +0.025/+0.051 (mm)	9.525 +0.025/+0.051	12.700 +/-0.127	BP0064-0095-0127-BS
6.350 (0.250") +0.051/+0.076 (mm)	9.525 +0.025/+0.051	12.700 +/-0.127	BP0064-0095-0127-BSHT
6.350 (0.250") +0.025/+0.051 (mm)	9.525 +0.051/+0.076	12.700 +/-0.127	BP0064-0095-0127-BSTH
6.350 (0.250") -0.013/+0.013 (mm)	9.525 +0.025/+0.051	12.700 +/-0.127	BP0064-0095-0127-BSUT
6.350 (0.250") -0.013/+0.013 (mm)	9.525 +0.025/+0.051	14.288 +/-0.127	BP0064-0095-0143-BSUT
6.350 (0.250") +0.025/+0.051 (mm)	9.525 +0.051/+0.076	14.478 +0/-0.152	BP0064-0095-0145-BSTH
6.350 (0.250") +0.025/+0.051 (mm)	9.525 +0.025/+0.051	15.875	BP0064-0095-0159-BS
6.350 (0.250") +0.025/+0.051 (mm)	9.525 +0.051/+0.076	15.875 +/-0.127	BP0064-0095-0159-BSTH
6.350 (0.250") -0.013/+0.013 (mm)	9.525 +0.025/+0.051	15.875 +/-0.127	BP0064-0095-0159-BSUT
6.350 (0.250") +0.025/+0.051 (mm)	9.525 +0.051/+0.076	18.263 +/-0.127	BP0064-0095-0183-BSTH
6.350 (0.250") +0.025/+0.051 (mm)	9.525 +0.025/+0.051	19.050	BP0064-0095-0191-BS
6.350 (0.250") +0.051/+0.076 (mm)	9.525 +0.025/+0.051	19.050 +/-0.127	BP0064-0095-0191-BSHT
6.350 (0.250") +0.025/+0.051 (mm)	9.525 +0.051/+0.076	19.050 +/-0.127	BP0064-0095-0191-BSTH
6.350 (0.250") -0.013/+0.013 (mm)	9.525 +0.025/+0.051	19.050 +/-0.127	BP0064-0095-0191-BSUT
6.350 (0.250") +0.025/+0.051 (mm)	9.525 +0.051/+0.076	22.225 +/-0.127	BP0064-0095-0222-BSTH
6.350 (0.250") -0.013/+0.013 (mm)	9.525 +0.025/+0.051	22.225	BP0064-0095-0222-BSUT
6.350 (0.250") +0.025/+0.051 (mm)	9.525 +0.051/+0.076	25.400 +/-0.127	BP0064-0095-0254-BSTH
6.350 (0.250") -0.013/+0.013 (mm)	9.525 +0.025/+0.051	25.400	BP0064-0095-0254-BSUT
6.350 (0.250") +0.025/+0.051 (mm)	9.525 +0.025/+0.051	25.400 +/-0.127	BP0064-0095-0254-BS
6.350 (0.250") +0.025/+0.051 (mm)	9.525 +0.025/+0.051	28.575 +/-0.127	BP0064-0095-0286-BS
6.350 (0.250") -0.013/+0.013 (mm)	9.525 +0.025/+0.051	28.575 +/-0.127	BP0064-0095-0286-BSUT
6.350 (0.250") +0.102/+0.127 (mm)	9.525 +0.025/+0.051	31.750	BP0064-0095-0318-BSHT
6.350 (0.250") -0.013/+0.013 (mm)	9.525 +0.025/+0.051	31.750 +/-0.127	BP0064-0095-0318-BSUT
6.350 (0.250") +0.000/+0.025 (mm)	11.113 +0.025/+0.051	9.525 +/-0.127	BP0064-0111-0095-BSLT
6.350 (0.250") +0.025/+0.051 (mm)	11.113 +0.051/+0.076	10.338 +/-0.127	BP0064-0111-0103-BSTH
6.350 (0.250") +0.025/+0.051 (mm)	11.113 +0.051/+0.076	11.100 +/-0.127	BP0064-0111-0111-BSTH
6.350 (0.250") +0.000/+0.025 (mm)	11.113 +0.025/+0.051	12.700 +/-0.127	BP0064-0111-0127-BSLT
6.350 (0.250") +0.025/+0.051 (mm)	11.113 +0.025/+0.051	12.700 +/-0.127	BP0064-0111-0127-BS
6.350 (0.250") +0.025/+0.051 (mm)	11.113 +0.025/+0.051	15.875 +/-0.127	BP0064-0111-0159-BS

Stocked or Short Delivery

Usually Available Short Delivery

Long delivery or not in current production

* Large Minimum Quantities

** Available only while stock last:

Bushes - Plain

Nominal ID (d) mm (inches)	Nominal OD (D) mm	Length (S) mm	Part Number
6.350 (0.250") +0.000/+0.025 (mm)	11.113 +0.025/+0.051	15.875 +/-0.127	BP0064-0111-0159-BSLT
6.350 (0.250") +0.025/+0.051 (mm)	11.113 +0.025/+0.051	19.050 +/-0.127	BP0064-0111-0191-BS
6.350 (0.250") +0.000/+0.025 (mm)	11.113 +0.025/+0.051	19.050 +/-0.127	BP0064-0111-0191-BSLT
6.350 (0.250") +0.000/+0.025 (mm)	11.113 +0.025/+0.051	22.225 +/-0.127	BP0064-0111-0222-BSLT
6.350 (0.250") +0.025/+0.051 (mm)	11.113 +0.025/+0.051	25.400 +/-0.127	BP0064-0111-0254-BS
6.350 (0.250") +0.000/+0.025 (mm)	11.113 +0.025/+0.051	25.400 +/-0.127	BP0064-0111-0254-BSLT
6.350 (0.250") +0.000/+0.010 (mm)	12.700 -0.010/+0.003	3.175 +0/-0.127	BP0064-0127-0032-BSLU
6.350 (0.250") +0.000/+0.010 (mm)	12.700 -0.010/+0.003	4.763 +0/-0.127	BP0064-0127-0048-BSLU
6.350 (0.250") +0.000/+0.025 (mm)	12.700 +0.051/+0.076	5.537 +/-0.127	BP0064-0127-0055-BSLH
6.350 (0.250") +0.025/+0.051 (mm)	12.700 +0.012/+0.038	7.938 +/-0.127	BP0064-0127-0079-BSTL
6.350 (0.250") +0.025/+0.051 (mm)	12.700 +0.051/+0.076	12.700 +/-0.127	BP0064-0127-0127-BSTH
6.350 (0.250") +0.025/+0.051 (mm)	12.700 +0.013/+0.038	12.700	BP0064-0127-0127-BSTL
6.350 (0.250") +0.025/+0.051 (mm)	12.700 +0.051/+0.076	19.050 +/-0.127	BP0064-0127-0191-BSTH
6.350 (0.250") +0.025/+0.051 (mm)	12.700 +0.013/+0.038	19.050	BP0064-0127-0191-BSTL
6.350 (0.250") +0.025/+0.051 (mm)	12.700 +0.051/+0.076	25.400 +/-0.127	BP0064-0127-0254-BSTH
6.350 (0.250") +0.025/+0.051 (mm)	12.700 +0.013/+0.038	25.400	BP0064-0127-0254-BSTL
6.350 (0.250") +0.000/+0.010 (mm)	15.875 -0.010/+0.003	4.978 +0/-0.127	BP0064-0159-0050-BSLU
7.000 (0.276") +0.005/+0.030 (mm)	10.000 +0.019/+0.040	5.000 +/-0.120	BP0070-0100-0050-BS
7.000 (0.276") +0.005/+0.030 (mm)	10.000 +0.019/+0.040	8.000 +/-0.127	BP0070-0100-0080-BSTL
7.000 (0.276") +0.005/+0.040 (mm)	10.000 +0.019/+0.040	10.000 +0/-0.200	BP0070-0100-0100-BSTL
7.000 (0.276") +0.005/+0.030 (mm)	11.000 +0.028/+0.050	8.000 +/-0.127	BP0070-0110-0080-BSHT
7.000 (0.276") +0.025/+0.040 (mm)	11.000 +0.028/+0.046	10.000 +/-0.127	BP0070-0110-0100-BS
7.912 (0.311") -0.025/+0.000 (mm)	11.113 -0.025/+0.000	9.525 +/-0.127	BP0079-0111-0095-BSUU
7.912 (0.311") -0.025/+0.000 (mm)	11.113 -0.025/+0.000	12.700 +/-0.127	BP0079-0111-0127-BSUU
7.938 (0.313") +0.012/+0.038 (mm)	9.525 +0.051/+0.076	3.175 +/-0.127	BP0079-0095-0032-BSLH
7.938 (0.313") +0.012/+0.038 (mm)	9.525 +0.051/+0.076	5.283 +/-0.127	BP0079-0095-0053-BSLH
7.938 (0.313") +0.025/+0.051 (mm)	9.525 +0.051/+0.076	6.350 +/-0.127	BP0079-0095-0064-BSTH
7.938 (0.313") +0.012/+0.038 (mm)	9.525 +0.051/+0.076	7.137 +/-0.127	BP0079-0095-0071-BSLH
7.938 (0.313") +0.000/+0.025 (mm)	9.525 +0.025/+0.051	7.938 +/-0.127	BP0079-0095-0079-BSLT
7.938 (0.313") +0.012/+0.038 (mm)	9.525 +0.051/+0.076	9.398 +/-0.127	BP0079-0095-0094-BSLH
7.938 (0.313") +0.000/+0.025 (mm)	9.525 +0.025/+0.051	9.525	BP0079-0095-0095-BSLT
7.938 (0.313") +0.025/+0.051 (mm)	9.525 +0.051/+0.076	9.525 +/-0.127	BP0079-0095-0095-BSTH
7.938 (0.313") +0.012/+0.038 (mm)	9.525 +0.051/+0.076	10.693 +/-0.127	BP0079-0095-0107-BSLH
7.938 (0.313") +0.012/+0.038 (mm)	9.525 +0.051/+0.076	12.370 +/-0.127	BP0079-0095-0124-BSLH

Stocked or Short Delivery

Usually Available Short Delivery

Long delivery or not in current production

* Large Minimum Quantities

** Available only while stock last:

Bushes - Plain

Nominal ID (d) mm (inches)	Nominal OD (D) mm	Length (S) mm	Part Number
7.938 (0.313") +0.000/+0.025 (mm)	9.525 +0.025/+0.051	12.700	BP0079-0095-0127-BSLT
7.938 (0.313") +0.025/+0.051 (mm)	9.525 +0.051/+0.076	12.700 +/-0.127	BP0079-0095-0127-BSTH
7.938 (0.313") +0.000/+0.025 (mm)	9.525 +0.025/+0.051	15.875	BP0079-0095-0159-BSLT
7.938 (0.313") +0.025/+0.051 (mm)	9.525 +0.051/+0.076	15.875 +/-0.127	BP0079-0095-0159-BSTH
7.938 (0.313") +0.000/+0.025 (mm)	9.525 +0.025/+0.051	19.050	BP0079-0095-0191-BSLT
7.938 (0.313") +0.025/+0.051 (mm)	9.525 +0.051/+0.076	19.050 +/-0.127	BP0079-0095-0191-BSTH
7.938 (0.313") +0.012/+0.038 (mm)	11.113 +0.051/+0.076	4.750 +/-0.127	BP0079-0111-0048-BSLH
7.938 (0.313") +0.051/+0.076 (mm)	11.113 +0.025/+0.051	6.350 +/-0.127	BP0079-0111-0064-BSHT
7.938 (0.313") -0.025/+0.000 (mm)	11.113 +0.038/+0.063	6.350 +/-0.127	BP0079-0111-0064-BSUH
7.938 (0.313") +0.000/+0.025 (mm)	11.113 +0.025/+0.051	6.350 +/-0.127	BP0079-0111-0064-BSLT
7.938 (0.313") +0.000/+0.025 (mm)	11.113 +0.025/+0.051	7.938 +/-0.127	BP0079-0111-0079-BSLT
7.938 (0.313") -0.025/+0.000 (mm)	11.113 +0.038/+0.063	7.938 +/-0.127	BP0079-0111-0079-BSUH
7.938 (0.313") +0.000/+0.025 (mm)	11.113 +0.025/+0.051	9.525 +/-0.127	BP0079-0111-0095-BSLT
7.938 (0.313") -0.025/+0.000 (mm)	11.113 +0.038/+0.063	9.525 +/-0.127	BP0079-0111-0095-BSUH
7.938 (0.313") +0.000/+0.025 (mm)	11.113 +0.025/+0.051	11.113 +/-0.127	BP0079-0111-0111-BSLT
7.938 (0.313") +0.000/+0.025 (mm)	11.113 +0.025/+0.051	12.700 +/-0.127	BP0079-0111-0127-BSLT
7.938 (0.313") +0.051/+0.076 (mm)	11.113 +0.025/+0.051	12.700 +/-0.127	BP0079-0111-0127-BSHT
7.938 (0.313") -0.025/+0.000 (mm)	11.113 +0.038/+0.063	12.700 +/-0.127	BP0079-0111-0127-BSUH
7.938 (0.313") +0.000/+0.025 (mm)	11.113 +0.025/+0.051	15.875 +/-0.127	BP0079-0111-0159-BSLT
7.938 (0.313") -0.025/+0.000 (mm)	11.113 +0.038/+0.063	15.875 +/-0.127	BP0079-0111-0159-BSUH
7.938 (0.313") +0.000/+0.025 (mm)	11.113 +0.025/+0.051	17.463 +/-0.127	BP0079-0111-0175-BSLT
7.938 (0.313") +0.051/+0.076 (mm)	11.113 +0.025/+0.051	19.050 +/-0.127	BP0079-0111-0191-BSHT
7.938 (0.313") +0.000/+0.025 (mm)	11.113 +0.025/+0.051	19.050 +/-0.127	BP0079-0111-0191-BSLT
7.938 (0.313") -0.025/+0.000 (mm)	11.113 +0.038/+0.063	19.050 +/-0.127	BP0079-0111-0191-BSUH
7.938 (0.313") +0.000/+0.025 (mm)	11.113 +0.025/+0.051	22.225 +/-0.127	BP0079-0111-0222-BSLT
7.938 (0.313") +0.000/+0.025 (mm)	11.113 +0.025/+0.051	25.400 +/-0.127	BP0079-0111-0254-BSLT
7.938 (0.313") +0.000/+0.025 (mm)	11.113 +0.025/+0.051	28.575 +/-0.127	BP0079-0111-0286-BSLT
7.938 (0.313") +0.000/+0.025 (mm)	11.113 +0.025/+0.051	31.750 +/-0.127	BP0079-0111-0318-BSLT
7.938 (0.313") +0.000/+0.025 (mm)	11.113 +0.025/+0.051	34.925 +/-0.127	BP0079-0111-0349-BSLT
7.938 (0.313") +0.025/+0.051 (mm)	12.700 +0.028/+0.046	6.350 +/-0.127	BP0079-0127-0064-BS
7.938 (0.313") +0.013/+0.038 (mm)	12.700 +0.051/+0.076	6.350	BP0079-0127-0064-BSLH
7.938 (0.313") +0.012/+0.038 (mm)	12.700 +0.051/+0.076	7.925 +/-0.127	BP0079-0127-0079-BSLH
7.938 (0.313") +0.025/+0.051 (mm)	12.700 +0.028/+0.046	9.525 +/-0.127	BP0079-0127-0095-BS
7.938 (0.313") +0.012/+0.038 (mm)	12.700 +0.051/+0.076	9.525 +/-0.127	BP0079-0127-0095-BSLH

Stocked or Short Delivery

Usually Available Short Delivery

Long delivery or not in current production

* Large Minimum Quantities

** Available only while stock last:

Bushes - Plain

Nominal ID (d) mm (inches)	Nominal OD (D) mm	Length (S) mm	Part Number
7.938 (0.313") -0.025/+0.000 (mm)	12.700 +0.051/+0.076	9.525 +/-0.127	BP0079-0127-0095-BSUH
7.938 (0.313") +0.012/+0.038 (mm)	12.700 +0.051/+0.076	11.100 +/-0.127	BP0079-0127-0111-BSLH
7.938 (0.313") -0.025/+0.000 (mm)	12.700 +0.051/+0.076	12.700 +/-0.127	BP0079-0127-0127-BSUH
7.938 (0.313") +0.025/+0.051 (mm)	12.700 +0.028/+0.046	12.700 +/-0.127	BP0079-0127-0127-BS
7.938 (0.313") +0.012/+0.038 (mm)	12.700 +0.051/+0.076	12.700 +/-0.127	BP0079-0127-0127-BSLH
7.938 (0.313") +0.012/+0.038 (mm)	12.700 +0.051/+0.076	14.288 +/-0.127	BP0079-0127-0143-BSLH
7.938 (0.313") +0.025/+0.051 (mm)	12.700 +0.028/+0.046	15.875 +/-0.127	BP0079-0127-0159-BS
7.938 (0.313") +0.012/+0.038 (mm)	12.700 +0.051/+0.076	15.875 +/-0.127	BP0079-0127-0159-BSLH
7.938 (0.313") -0.025/+0.000 (mm)	12.700 +0.051/+0.076	15.875 +/-0.127	BP0079-0127-0159-BSUH
7.938 (0.313") +0.012/+0.038 (mm)	12.700 +0.051/+0.076	17.856 +/-0.127	BP0079-0127-0179-BSLH
7.938 (0.313") +0.012/+0.038 (mm)	12.700 +0.051/+0.076	19.050 +/-0.127	BP0079-0127-0191-BSLH
7.938 (0.313") -0.025/+0.000 (mm)	12.700 +0.051/+0.076	19.050 +/-0.127	BP0079-0127-0191-BSUH
7.938 (0.313") -0.025/+0.000 (mm)	12.700 +0.051/+0.076	22.225 +/-0.127	BP0079-0127-0222-BSUH
7.938 (0.313") -0.025/+0.000 (mm)	12.700 +0.051/+0.076	25.400 +/-0.127	BP0079-0127-0254-BSUH
7.938 (0.313") +0.012/+0.038 (mm)	12.700 +0.051/+0.076	25.400 +/-0.127	BP0079-0127-0254-BSLH
7.938 (0.313") +0.000/+0.010 (mm)	17.463 -0.010/+0.003	6.350 +0/-0.127	BP0079-0175-0064-BSLU
8.000 (0.315") +0.005/+0.030 (mm)	10.000 +0.019/+0.040	8.000 +/-0.120	BP0080-0100-0080-BS
8.000 (0.315") +0.005/+0.030 (mm)	10.000 +0.019/+0.040	10.000 +/-0.120	BP0080-0100-0100-BS
8.000 (0.315") +0.025/+0.051 (mm)	11.000 +0.028/+0.046	6.000 +/-0.127	BP0080-0110-0060-BS
8.000 (0.315") +0.005/+0.030 (mm)	11.000 +0.028/+0.050	8.000 +/-0.127	BP0080-0110-0080-BS
8.000 (0.315") +0.005/+0.030 (mm)	11.000 +0.028/+0.050	12.000 +/-0.127	BP0080-0110-0120-BS
8.000 (0.315") +0.005/+0.030 (mm)	11.000 +0.028/+0.050	16.000 +/-0.120	BP0080-0110-0160-BS
8.000 (0.315") +0.005/+0.030 (mm)	11.000 +0.028/+0.050	20.000 +/-0.120	BP0080-0110-0200-BS
8.000 (0.315") +0.005/+0.040 (mm)	12.000 +0.028/+0.050	6.000 +0/-0.200	BP0080-0120-0060-BS
8.000 (0.315") +0.005/+0.040 (mm)	12.000 +0.028/+0.050	8.000 +0/-0.200	BP0080-0120-0080-BS
8.000 (0.315") +0.005/+0.030 (mm)	12.000 +0.028/+0.050	10.000 +/-0.120	BP0080-0120-0100-BS
8.000 (0.315") +0.005/+0.040 (mm)	12.000 +0.028/+0.050	12.000 +0/-0.200	BP0080-0120-0120-BS
8.000 (0.315") +0.005/+0.030 (mm)	12.000 +0.028/+0.050	14.000 +/-0.120	BP0080-0120-0140-BS
8.000 (0.315") +0.005/+0.030 (mm)	12.000 +0.028/+0.050	16.000 +/-0.127	BP0080-0120-0160-BS
8.000 (0.315") +0.005/+0.030 (mm)	12.000 +0.028/+0.050	20.000 +/-0.127	BP0080-0120-0200-BS
8.000 (0.315") +0.005/+0.040 (mm)	14.000 +0.028/+0.050	8.000 +0/-0.200	BP0080-0140-0080-BS
8.000 (0.315") +0.005/+0.040 (mm)	14.000 +0.028/+0.050	12.000 +0/-0.200	BP0080-0140-0120-BS
8.000 (0.315") +0.005/+0.030 (mm)	14.000 +0.028/+0.050	14.000 +/-0.120	BP0080-0140-0140-BS
8.000 (0.315") +0.005/+0.040 (mm)	14.000 +0.028/+0.050	16.000 +0/-0.200	BP0080-0140-0160-BS

 Stocked or Short Delivery

 Usually Available Short Delivery

 Long delivery or not in current production

* Large Minimum Quantities

** Available only while stock last:

Bushes - Plain

Nominal ID (d) mm (inches)	Nominal OD (D) mm	Length (S) mm	Part Number
8.000 (0.315") +0.005/+0.030 (mm)	14.000 +0.028/+0.050	20.000 +/-0.120	BP0080-0140-0200-BS
8.000 (0.315") +0.000/+0.015 (mm)	16.000 -0.011/+0.000	6.000 +0/-0.170	BP0080-0160-0060-BSLU
8.334 (0.328") -0.000/+0.025 (mm)	11.906 +0.058/+0.084	12.700 +/-0.127	BP0083-0119-0127-BSLH
8.334 (0.328") +0.000/+0.025 (mm)	11.906 +0.058/+0.084	19.050 +/-0.127	BP0083-0119-0191-BSLH
8.334 (0.328") +0.000/+0.025 (mm)	12.700 +0.051/+0.076	11.100 +/-0.127	BP0083-0127-0111-BSLH
9.000 (0.354") +0.005/+0.030 (mm)	12.000 +0.028/+0.050	6.000 +/-0.120	BP0090-0120-0060-BS
9.000 (0.354") +0.005/+0.030 (mm)	12.000 +0.028/+0.050	10.000 +/-0.127	BP0090-0120-0100-BS
9.000 (0.354") +0.005/+0.030 (mm)	12.000 +0.028/+0.050	14.000 +/-0.127	BP0090-0120-0140-BS
9.000 (0.354") +0.025/+0.051 (mm)	14.000 +0.028/+0.046	6.000 +/-0.127	BP0090-0140-0060-BS
9.000 (0.354") +0.025/+0.051 (mm)	14.000 +0.028/+0.046	10.000 +/-0.127	BP0090-0140-0100-BS
9.000 (0.354") +0.005/+0.030 (mm)	14.000 +0.028/+0.050	14.000 +/-0.127	BP0090-0140-0140-BSLT
9.525 (0.375") +0.012/+0.038 (mm)	11.113 +0.038/+0.063	6.350 +/-0.127	BP0095-0111-0064-BSLH
9.525 (0.375") +0.012/+0.038 (mm)	11.113 +0.038/+0.063	9.525 +/-0.127	BP0095-0111-0095-BSLH
9.525 (0.375") +0.012/+0.038 (mm)	11.113 +0.038/+0.063	12.700 +/-0.127	BP0095-0111-0127-BSLH
9.525 (0.375") +0.012/+0.038 (mm)	11.113 +0.038/+0.063	19.050 +/-0.127	BP0095-0111-0191-BSLH
9.525 (0.375") +0.013/+0.038 (mm)	12.700 +0.051/+0.076	4.750	BP0095-0127-0048-BSLH
9.525 (0.375") +0.025/+0.051 (mm)	12.700 +0.051/+0.076	4.750 +0/-0.102	BP0095-0127-0048-BSTH
9.525 (0.375") +0.051/+0.076 (mm)	12.700 +0.038/+0.063	6.350 +/-0.127	BP0095-0127-0064-BSHH
9.525 (0.375") -0.025/+0.000 (mm)	12.700 +0.051/+0.076	6.350 +/-0.127	BP0095-0127-0064-BSUH
9.525 (0.375") +0.012/+0.038 (mm)	12.700 +0.051/+0.076	6.350 +/-0.127	BP0095-0127-0064-BSLH
9.525 (0.375") +0.025/+0.051 (mm)	12.700 +0.051/+0.076	6.350 +/-0.127	BP0095-0127-0064-BSTH
9.525 (0.375") +0.012/+0.038 (mm)	12.700 +0.051/+0.076	7.938 +/-0.127	BP0095-0127-0079-BSLH
9.525 (0.375") +0.012/+0.038 (mm)	12.700 +0.051/+0.076	9.525 +/-0.127	BP0095-0127-0095-BSLH
9.525 (0.375") +0.025/+0.051 (mm)	12.700 +0.051/+0.076	9.525 +/-0.127	BP0095-0127-0095-BSTH
9.525 (0.375") -0.025/+0.000 (mm)	12.700 +0.051/+0.076	9.525 +/-0.127	BP0095-0127-0095-BSUH
9.525 (0.375") +0.012/+0.038 (mm)	12.700 +0.051/+0.076	11.113 +/-0.127	BP0095-0127-0111-BSLH
9.525 (0.375") -0.025/+0.000 (mm)	12.700 +0.051/+0.076	11.113 +/-0.127	BP0095-0127-0111-BSUH
9.525 (0.375") +0.012/+0.038 (mm)	12.700 +0.051/+0.076	12.700 +/-0.127	BP0095-0127-0127-BSLH
9.525 (0.375") +0.025/+0.051 (mm)	12.700 +0.051/+0.076	12.700 +/-0.127	BP0095-0127-0127-BSTH
9.525 (0.375") -0.025/+0.000 (mm)	12.700 +0.051/+0.076	12.700 +/-0.127	BP0095-0127-0127-BSUH
9.525 (0.375") +0.051/+0.076 (mm)	12.700 +0.038/+0.063	12.700 +/-0.127	BP0095-0127-0127-BSHH
9.525 (0.375") +0.051/+0.076 (mm)	12.700 +0.038/+0.063	15.875 +/-0.127	BP0095-0127-0159-BSHH
9.525 (0.375") +0.012/+0.038 (mm)	12.700 +0.051/+0.076	15.875 +/-0.127	BP0095-0127-0159-BSLH
9.525 (0.375") +0.025/+0.051 (mm)	12.700 +0.051/+0.076	15.875 +/-0.127	BP0095-0127-0159-BSTH

Stocked or Short Delivery

Usually Available Short Delivery

Long delivery or not in current production

* Large Minimum Quantities

** Available only while stock last:

Bushes - Plain

Nominal ID (d) mm (inches)	Nominal OD (D) mm	Length (S) mm	Part Number
9.525 (0.375") -0.025/+0.000 (mm)	12.700 +0.051/+0.076	15.875 +/-0.127	BP0095-0127-0159-BSUH
9.525 (0.375") -0.025/+0.000 (mm)	12.700 +0.051/+0.076	19.050 +/-0.127	BP0095-0127-0191-BSUH
9.525 (0.375") +0.051/+0.076 (mm)	12.700 +0.038/+0.063	19.050 +/-0.127	BP0095-0127-0191-BSHH
9.525 (0.375") +0.012/+0.038 (mm)	12.700 +0.051/+0.076	19.050 +/-0.127	BP0095-0127-0191-BSLH
9.525 (0.375") +0.025/+0.051 (mm)	12.700 +0.051/+0.076	19.050 +/-0.127	BP0095-0127-0191-BSTH
9.525 (0.375") +0.025/+0.051 (mm)	12.700 +0.051/+0.076	20.650 +/-0.127	BP0095-0127-0207-BSTH
9.525 (0.375") +0.025/+0.051 (mm)	12.700 +0.051/+0.076	22.225 +/-0.127	BP0095-0127-0222-BSTH
9.525 (0.375") -0.025/+0.000 (mm)	12.700 +0.051/+0.076	22.225 +/-0.127	BP0095-0127-0222-BSUH
9.525 (0.375") +0.012/+0.038 (mm)	12.700 +0.051/+0.076	22.225 +/-0.127	BP0095-0127-0222-BSLH
9.525 (0.375") +0.051/+0.076 (mm)	12.700 +0.038/+0.063	25.400 +/-0.127	BP0095-0127-0254-BSHH
9.525 (0.375") +0.012/+0.038 (mm)	12.700 +0.051/+0.076	25.400 +/-0.127	BP0095-0127-0254-BSLH
9.525 (0.375") +0.025/+0.051 (mm)	12.700 +0.051/+0.076	25.400 +/-0.127	BP0095-0127-0254-BSTH
9.525 (0.375") -0.025/+0.000 (mm)	12.700 +0.051/+0.076	25.400 +/-0.127	BP0095-0127-0254-BSUH
9.525 (0.375") +0.012/+0.038 (mm)	12.700 +0.051/+0.076	28.575 +/-0.127	BP0095-0127-0286-BSLH
9.525 (0.375") +0.025/+0.051 (mm)	12.700 +0.051/+0.076	31.750 +/-0.127	BP0095-0127-0318-BSTH
9.525 (0.375") -0.025/+0.000 (mm)	12.700 +0.051/+0.076	31.750 +/-0.127	BP0095-0127-0318-BSUH
9.525 (0.375") +0.025/+0.051 (mm)	14.288 +0.051/+0.076	8.331 +/-0.127	BP0095-0143-0083-BSTH
9.525 (0.375") +0.051/+0.076 (mm)	14.288 +0.038/+0.063	9.525 +/-0.127	BP0095-0143-0095-BSHH
9.525 (0.375") +0.013/+0.038 (mm)	14.288 +0.051/+0.076	9.525 +/-0.127	BP0095-0143-0095-BSLH
9.525 (0.375") +0.051/+0.076 (mm)	14.288 +0.038/+0.063	12.700 +/-0.127	BP0095-0143-0127-BSHH
9.525 (0.375") +0.013/+0.038 (mm)	14.288 +0.051/+0.076	12.700 +/-0.127	BP0095-0143-0127-BSLH
9.525 (0.375") +0.025/+0.051 (mm)	14.288 +0.051/+0.076	12.700 +/-0.127	BP0095-0143-0127-BSTH
9.525 (0.375") +0.012/+0.038 (mm)	14.288 +0.051/+0.076	14.288 +/-0.127	BP0095-0143-0143-BSLH
9.525 (0.375") +0.051/+0.076 (mm)	14.288 +0.038/+0.063	15.875 +/-0.127	BP0095-0143-0159-BSHH
9.525 (0.375") +0.012/+0.038 (mm)	14.288 +0.051/+0.076	17.463 +/-0.127	BP0095-0143-0175-BSLH
9.525 (0.375") +0.013/+0.038 (mm)	14.288 +0.051/+0.076	19.050 +/-0.127	BP0095-0143-0191-BSLH
9.525 (0.375") +0.025/+0.051 (mm)	14.288 +0.051/+0.076	19.050 +/-0.127	BP0095-0143-0191-BSTH
9.525 (0.375") +0.025/+0.051 (mm)	14.288 +0.051/+0.076	19.177 +/-0.127	BP0095-0143-0192-BSTH
9.525 (0.375") +0.051/+0.076 (mm)	14.288 +0.038/+0.063	22.225 +/-0.127	BP0095-0143-0222-BSHH
9.525 (0.375") +0.025/+0.051 (mm)	14.288 +0.051/+0.076	25.273 +/-0.127	BP0095-0143-0253-BSTH
9.525 (0.375") +0.013/+0.038 (mm)	14.288 +0.051/+0.076	25.400 +/-0.127	BP0095-0143-0254-BSLH
9.525 (0.375") +0.025/+0.051 (mm)	14.288 +0.051/+0.076	25.400 +/-0.127	BP0095-0143-0254-BSTH
9.525 (0.375") +0.013/+0.038 (mm)	14.288 +0.051/+0.076	31.750 +/-0.127	BP0095-0143-0318-BSLH
9.525 (0.375") +0.025/+0.051 (mm)	14.288 +0.051/+0.076	31.750 +/-0.127	BP0095-0143-0318-BSTH

 Stocked or Short Delivery

 Usually Available Short Delivery

 Long delivery or not in current production

* Large Minimum Quantities

** Available only while stock last:

Bushes - Plain

Nominal ID (d) mm (inches)	Nominal OD (D) mm	Length (S) mm	Part Number
9.525 (0.375") +0.025/+0.051 (mm)	15.875 +0.051/+0.076	7.925 +/-0.127	BP0095-0159-0079-BSTH
9.525 (0.375") +0.000/+0.025 (mm)	15.875 +0.025/+0.051	9.525	BP0095-0159-0095-BSLT
9.525 (0.375") +0.025/+0.051 (mm)	15.875 +0.051/+0.076	9.525 +/-0.127	BP0095-0159-0095-BSTH
9.525 (0.375") +0.025/+0.051 (mm)	15.875 +0.051/+0.076	10.973 +/-0.127	BP0095-0159-0110-BSTH
9.525 (0.375") +0.000/+0.025 (mm)	15.875 +0.025/+0.051	11.113 +/-0.127	BP0095-0159-0111-BSLT
9.525 (0.375") +0.000/+0.025 (mm)	15.875 +0.025/+0.051	12.700	BP0095-0159-0127-BSLT
9.525 (0.375") +0.025/+0.051 (mm)	15.875 +0.051/+0.076	12.700 +/-0.127	BP0095-0159-0127-BSTH
9.525 (0.375") +0.051/+0.076 (mm)	15.875 +0.051/+0.076	15.875 +/-0.127	BP0095-0159-0159-BSHH
9.525 (0.375") +0.000/+0.025 (mm)	15.875 +0.025/+0.051	15.875	BP0095-0159-0159-BSLT
9.525 (0.375") +0.025/+0.051 (mm)	15.875 +0.051/+0.076	15.926 +0/-0.102	BP0095-0159-0160-BSTH
9.525 (0.375") +0.025/+0.051 (mm)	15.875 +0.051/+0.076	19.050 +/-0.127	BP0095-0159-0191-BSTH
9.525 (0.375") +0.000/+0.025 (mm)	15.875 +0.025/+0.051	19.050	BP0095-0159-0191-BSLT
9.525 (0.375") +0.051/+0.076 (mm)	15.875 +0.051/+0.076	22.225 +/-0.127	BP0095-0159-0222-BSHH
9.525 (0.375") +0.000/+0.025 (mm)	15.875 +0.025/+0.051	22.225	BP0095-0159-0222-BSLT
9.525 (0.375") +0.051/+0.076 (mm)	15.875 +0.051/+0.076	25.400 +/-0.127	BP0095-0159-0254-BSHH
9.525 (0.375") +0.000/+0.025 (mm)	15.875 +0.025/+0.051	25.400	BP0095-0159-0254-BSLT
9.525 (0.375") +0.000/+0.025 (mm)	15.875 +0.025/+0.051	28.575 +/-0.127	BP0095-0159-0286-BSLT
9.525 (0.375") +0.051/+0.076 (mm)	15.875 +0.051/+0.076	31.750 +/-0.127	BP0095-0159-0318-BSHH
9.525 (0.375") +0.000/+0.025 (mm)	15.875 +0.025/+0.051	31.750	BP0095-0159-0318-BSLT
9.525 (0.375") +0.051/+0.076 (mm)	15.875 +0.051/+0.076	38.100 +/-0.127	BP0095-0159-0381-BSHH
9.525 (0.375") +0.012/+0.038 (mm)	17.463 +0.012/+0.038	19.050 +/-0.127	BP0095-0175-0191-BSLL
9.525 (0.375") +0.012/+0.038 (mm)	17.463 +0.012/+0.038	38.100 +/-0.127	BP0095-0175-0381-BSLL
9.525 (0.375") +0.051/+0.076 (mm)	19.050 +0.051/+0.076	9.525 +/-0.127	BP0095-0191-0095-BSHH
9.525 (0.375") +0.025/+0.051 (mm)	19.050 +0.051/+0.076	12.700 +/-0.127	BP0095-0191-0127-BSTH
9.525 (0.375") +0.051/+0.076 (mm)	19.050 +0.051/+0.076	19.050 +/-0.127	BP0095-0191-0191-BSHH
9.525 (0.375") +0.025/+0.051 (mm)	19.050 +0.051/+0.076	19.050	BP0095-0191-0191-BSTH
9.525 (0.375") +0.051/+0.076 (mm)	19.050 +0.051/+0.076	25.400 +/-0.127	BP0095-0191-0254-BSHH
9.525 (0.375") +0.025/+0.051 (mm)	19.050 +0.051/+0.076	25.400	BP0095-0191-0254-BSTH
9.525 (0.375") +0.051/+0.076 (mm)	19.050 +0.051/+0.076	31.750 +/-0.127	BP0095-0191-0318-BSHH
9.525 (0.375") +0.025/+0.051 (mm)	19.050 +0.051/+0.076	31.750	BP0095-0191-0318-BSTH
9.525 (0.375") +0.000/+0.010 (mm)	22.225 -0.010/+0.003	7.137 +0/-0.127	BP0095-0222-0071-BSLU
10.000 (0.394") +0.005/+0.030 (mm)	12.000 +0.028/+0.050	10.000 +/-0.120	BP0100-0120-0100-BS
10.000 (0.394") +0.005/+0.030 (mm)	12.000 +0.028/+0.050	11.000 +/-0.120	BP0100-0120-0110-BS
10.000 (0.394") +0.005/+0.030 (mm)	12.000 +0.028/+0.050	20.000 +/-0.120	BP0100-0120-0200-BS

 Stocked or Short Delivery

 Usually Available Short Delivery

 Long delivery or not in current production

* Large Minimum Quantities

** Available only while stock last:

Bushes - Plain

Nominal ID (d) mm (inches)	Nominal OD (D) mm	Length (S) mm	Part Number
10.000 (0.394") +0.005/+0.030 (mm)	13.000 +0.028/+0.050	10.000 +/-0.120	BP0100-0130-0100-BS
10.000 (0.394") +0.005/+0.030 (mm)	13.000 +0.028/+0.050	12.000 +/-0.120	BP0100-0130-0120-BS
10.000 (0.394") +0.005/+0.030 (mm)	13.000 +0.028/+0.050	16.000 +/-0.120	BP0100-0130-0160-BS
10.000 (0.394") +0.005/+0.030 (mm)	13.000 +0.028/+0.050	18.000 +/-0.120	BP0100-0130-0180-BS
10.000 (0.394") +0.005/+0.030 (mm)	13.000 +0.028/+0.050	20.000 +/-0.120	BP0100-0130-0200-BS
10.000 (0.394") +0.005/+0.030 (mm)	13.000 +0.028/+0.050	25.000 +/-0.120	BP0100-0130-0250-BS
10.000 (0.394") +0.005/+0.030 (mm)	14.000 +0.028/+0.050	8.000 +/-0.127	BP0100-0140-0080-BS
10.000 (0.394") +0.005/+0.030 (mm)	14.000 +0.028/+0.050	10.000 +/-0.127	BP0100-0140-0100-BSLT
10.000 (0.394") +0.005/+0.030 (mm)	14.000 +0.028/+0.050	14.000 +/-0.120	BP0100-0140-0140-BS
10.000 (0.394") +0.005/+0.030 (mm)	14.000 +0.028/+0.050	15.000 +/-0.120	BP0100-0140-0150-BS
10.000 (0.394") +0.005/+0.030 (mm)	14.000 +0.028/+0.050	16.000 +/-0.127	BP0100-0140-0160-BSLT
10.000 (0.394") +0.005/+0.030 (mm)	14.000 +0.028/+0.050	18.000 +/-0.120	BP0100-0140-0180-BS
10.000 (0.394") +0.005/+0.030 (mm)	14.000 +0.028/+0.050	20.000 +/-0.127	BP0100-0140-0200-BS
10.000 (0.394") +0.005/+0.030 (mm)	14.000 +0.028/+0.050	25.000 +/-0.127	BP0100-0140-0250-BS
10.000 (0.394") +0.005/+0.030 (mm)	15.000 +0.028/+0.050	10.000 +/-0.120	BP0100-0150-0100-BS
10.000 (0.394") +0.005/+0.030 (mm)	15.000 +0.028/+0.050	16.000 +/-0.120	BP0100-0150-0160-BS
10.000 (0.394") +0.005/+0.030 (mm)	15.000 +0.028/+0.050	20.000 +/-0.120	BP0100-0150-0200-BS
10.000 (0.394") +0.005/+0.030 (mm)	15.000 +0.028/+0.050	25.000 +/-0.120	BP0100-0150-0250-BS
10.000 (0.394") +0.005/+0.030 (mm)	16.000 +0.028/+0.050	8.000 +/-0.127	BP0100-0160-0080-BSLT
10.000 (0.394") +0.005/+0.030 (mm)	16.000 +0.028/+0.050	10.000 +/-0.127	BP0100-0160-0100-BSLT
10.000 (0.394") +0.005/+0.030 (mm)	16.000 +0.028/+0.050	15.000 +/-0.120	BP0100-0160-0150-BS
10.000 (0.394") +0.005/+0.030 (mm)	16.000 +0.028/+0.050	16.000 +/-0.127	BP0100-0160-0160-BSLH
10.000 (0.394") +0.005/+0.040 (mm)	16.000 +0.028/+0.050	20.000 +0/-0.200	BP0100-0160-0200-BS
10.000 (0.394") +0.005/+0.030 (mm)	16.000 +0.028/+0.050	25.000 +/-0.127	BP0100-0160-0250-BS
10.000 (0.394") +0.000/+0.015 (mm)	19.000 -0.013/+0.000	7.000 +0/-0.170	BP0100-0190-0070-BSLU
11.113 (0.438") +0.012/+0.038 (mm)	14.288 +0.038/+0.063	7.938 +/-0.127	BP0111-0143-0079-BSLH
11.113 (0.438") +0.038/+0.063 (mm)	14.288 +0.038/+0.063	9.525 +/-0.127	BP0111-0143-0095-BSHH
11.113 (0.438") +0.012/+0.038 (mm)	14.288 +0.038/+0.063	9.525 +/-0.127	BP0111-0143-0095-BSLH
11.113 (0.438") +0.038/+0.063 (mm)	14.288 +0.038/+0.063	12.700 +/-0.127	BP0111-0143-0127-BSHH
11.113 (0.438") +0.012/+0.038 (mm)	14.288 +0.038/+0.063	12.700 +/-0.127	BP0111-0143-0127-BSLH
11.113 (0.438") +0.038/+0.063 (mm)	14.288 +0.038/+0.063	15.875 +/-0.127	BP0111-0143-0159-BSHH
11.113 (0.438") +0.012/+0.038 (mm)	14.288 +0.038/+0.063	15.875 +/-0.127	BP0111-0143-0159-BSLH
11.113 (0.438") +0.051/+0.076 (mm)	14.288 +0.051/+0.076	18.110 +/-0.127	BP0111-0143-0181-BSHH
11.113 (0.438") +0.038/+0.063 (mm)	14.288 +0.038/+0.063	19.050 +/-0.127	BP0111-0143-0191-BSHH

Stocked or Short Delivery

Usually Available Short Delivery

Long delivery or not in current production

* Large Minimum Quantities

** Available only while stock last:

Bushes - Plain

Nominal ID (d) mm (inches)	Nominal OD (D) mm	Length (S) mm	Part Number
11.113 (0.438") +0.012/+0.038 (mm)	14.288 +0.038/+0.063	19.050 +/-0.127	BP0111-0143-0191-BSLH
11.113 (0.438") +0.012/+0.038 (mm)	14.288 +0.038/+0.063	20.638 +/-0.127	BP0111-0143-0206-BSLH
11.113 (0.438") +0.038/+0.063 (mm)	14.288 +0.038/+0.063	22.225 +/-0.127	BP0111-0143-0222-BSHH
11.113 (0.438") +0.012/+0.038 (mm)	14.288 +0.038/+0.063	23.813 +/-0.127	BP0111-0143-0238-BSLH
11.113 (0.438") +0.038/+0.063 (mm)	14.288 +0.038/+0.063	25.400 +/-0.127	BP0111-0143-0254-BSHH
11.113 (0.438") +0.012/+0.038 (mm)	14.288 +0.038/+0.063	25.400 +/-0.127	BP0111-0143-0254-BSLH
11.113 (0.438") +0.038/+0.063 (mm)	14.288 +0.038/+0.063	31.750 +/-0.127	BP0111-0143-0318-BSHH
11.113 (0.438") +0.038/+0.063 (mm)	15.875 +0.051/+0.076	9.525 +/-0.127	BP0111-0159-0095-BSHH
11.113 (0.438") +0.013/+0.038 (mm)	15.875 +0.025/+0.051	9.525	BP0111-0159-0095-BSLT
11.113 (0.438") +0.012/+0.038 (mm)	15.875 +0.025/+0.051	11.113 +/-0.127	BP0111-0159-0111-BSLT
11.113 (0.438") +0.025/+0.051 (mm)	15.875 +0.051/+0.076	12.700 +/-0.127	BP0111-0159-0127-BSTH
11.113 (0.438") +0.013/+0.038 (mm)	15.875 +0.025/+0.051	12.700	BP0111-0159-0127-BSLT
11.113 (0.438") +0.013/+0.038 (mm)	15.875 +0.025/+0.051	15.875	BP0111-0159-0159-BSLT
11.113 (0.438") +0.038/+0.063 (mm)	15.875 +0.051/+0.076	15.875 +/-0.127	BP0111-0159-0159-BSHH
11.113 (0.438") +0.013/+0.038 (mm)	15.875 +0.025/+0.051	19.050	BP0111-0159-0191-BSLT
11.113 (0.438") +0.025/+0.051 (mm)	15.875 +0.051/+0.076	19.050 +/-0.127	BP0111-0159-0191-BSTH
11.113 (0.438") +0.038/+0.063 (mm)	15.875 +0.051/+0.076	22.225 +/-0.127	BP0111-0159-0222-BSHH
11.113 (0.438") +0.013/+0.038 (mm)	15.875 +0.025/+0.051	25.400	BP0111-0159-0254-BSLT
11.113 (0.438") +0.025/+0.051 (mm)	15.875 +0.051/+0.076	25.400 +/-0.127	BP0111-0159-0254-BSTH
11.113 (0.438") +0.038/+0.063 (mm)	15.875 +0.051/+0.076	31.750 +/-0.127	BP0111-0159-0318-BSHH
11.113 (0.438") +0.013/+0.038 (mm)	15.875 +0.025/+0.051	31.750	BP0111-0159-0318-BSLT
11.113 (0.438") +0.038/+0.063 (mm)	15.875 +0.051/+0.076	38.100 +/-0.127	BP0111-0159-0381-BSHH
11.113 (0.438") +0.013/+0.038 (mm)	15.875 +0.025/+0.051	38.100	BP0111-0159-0381-BSLT
11.113 (0.438") +0.025/+0.051 (mm)	17.463 +0.051/+0.076	12.700 +/-0.127	BP0111-0175-0127-BSTH
11.113 (0.438") +0.025/+0.051 (mm)	17.463 +0.051/+0.076	25.400 +/-0.127	BP0111-0175-0254-BSTH
11.113 (0.438") +0.025/+0.051 (mm)	17.463 +0.051/+0.076	38.100 +/-0.127	BP0111-0175-0381-BSTH
12.000 (0.472") +0.005/+0.030 (mm)	14.000 +0.028/+0.050	9.000 +/-0.120	BP0120-0140-0090-BS
12.000 (0.472") +0.005/+0.030 (mm)	14.000 +0.028/+0.050	12.000 +/-0.120	BP0120-0140-0120-BS
12.000 (0.472") +0.005/+0.030 (mm)	14.000 +0.028/+0.050	14.000 +/-0.120	BP0120-0140-0140-BS
12.000 (0.472") +0.005/+0.030 (mm)	14.000 +0.028/+0.050	16.000 +/-0.120	BP0120-0140-0160-BS
12.000 (0.472") +0.005/+0.030 (mm)	15.000 +0.028/+0.050	8.000 +/-0.120	BP0120-0150-0080-BS
12.000 (0.472") +0.005/+0.030 (mm)	15.000 +0.028/+0.050	12.000 +/-0.120	BP0120-0150-0120-BS
12.000 (0.472") +0.005/+0.030 (mm)	15.000 +0.028/+0.050	16.000 +/-0.120	BP0120-0150-0160-BS
12.000 (0.472") +0.005/+0.030 (mm)	15.000 +0.028/+0.050	18.000 +/-0.120	BP0120-0150-0180-BS

 Stocked or Short Delivery

 Usually Available Short Delivery

 Long delivery or not in current production

* Large Minimum Quantities

** Available only while stock last:

Bushes - Plain

Nominal ID (d) mm (inches)	Nominal OD (D) mm	Length (S) mm	Part Number
12.000 (0.472") +0.005/+0.030 (mm)	15.000 +0.028/+0.050	20.000 +/-0.120	BP0120-0150-0200-BS
12.000 (0.472") +0.005/+0.030 (mm)	15.000 +0.028/+0.050	25.000 +/-0.120	BP0120-0150-0250-BS
12.000 (0.472") +0.005/+0.030 (mm)	16.000 +0.028/+0.050	8.000 +/-0.127	BP0120-0160-0080-BS
12.000 (0.472") +0.005/+0.030 (mm)	16.000 +0.028/+0.050	12.000 +/-0.127	BP0120-0160-0120-BSLT
12.000 (0.472") +0.005/+0.030 (mm)	16.000 +0.028/+0.050	15.000 +/-0.120	BP0120-0160-0150-BS
12.000 (0.472") +0.005/+0.030 (mm)	16.000 +0.028/+0.050	16.000 +/-0.127	BP0120-0160-0160-BS
12.000 (0.472") +0.005/+0.040 (mm)	16.000 +0.028/+0.050	20.000 +0/-0.200	BP0120-0160-0200-BS
12.000 (0.472") +0.005/+0.030 (mm)	16.000 +0.028/+0.050	25.000 +/-0.127	BP0120-0160-0250-BS
12.000 (0.472") +0.005/+0.030 (mm)	16.000 +0.028/+0.050	27.000 +/-0.120	BP0120-0160-0270-BS
12.000 (0.472") +0.005/+0.030 (mm)	17.000 +0.028/+0.050	10.000 +/-0.120	BP0120-0170-0100-BS
12.000 (0.472") +0.005/+0.030 (mm)	17.000 +0.028/+0.050	12.000 +/-0.120	BP0120-0170-0120-BS
12.000 (0.472") +0.005/+0.030 (mm)	17.000 +0.028/+0.050	16.000 +/-0.120	BP0120-0170-0160-BS
12.000 (0.472") +0.005/+0.030 (mm)	17.000 +0.028/+0.050	18.000 +/-0.120	BP0120-0170-0180-BS
12.000 (0.472") +0.005/+0.030 (mm)	17.000 +0.028/+0.050	20.000 +/-0.120	BP0120-0170-0200-BS
12.000 (0.472") +0.005/+0.030 (mm)	17.000 +0.028/+0.050	25.000 +/-0.120	BP0120-0170-0250-BS
12.000 (0.472") +0.005/+0.030 (mm)	18.000 +0.028/+0.050	8.000 +/-0.127	BP0120-0180-0080-BS
12.000 (0.472") +0.005/+0.030 (mm)	18.000 +0.028/+0.050	10.000 +/-0.127	BP0120-0180-0100-BSLT
12.000 (0.472") +0.005/+0.030 (mm)	18.000 +0.028/+0.050	12.000 +/-0.127	BP0120-0180-0120-BSLT
12.000 (0.472") +0.005/+0.030 (mm)	18.000 +0.028/+0.050	16.000 +0/-0.200	BP0120-0180-0160-BS
12.000 (0.472") +0.005/+0.030 (mm)	18.000 +0.028/+0.050	18.000 +/-0.120	BP0120-0180-0180-BS
12.000 (0.472") +0.005/+0.030 (mm)	18.000 +0.028/+0.050	20.000 +/-0.127	BP0120-0180-0200-BS
12.000 (0.472") +0.005/+0.030 (mm)	18.000 +0.028/+0.050	25.000 +0/-0.200	BP0120-0180-0250-BS
12.000 (0.472") +0.005/+0.030 (mm)	20.000 +0.035/+0.060	8.000 +0/-0.170	BP0120-0200-0080-BSLU
12.700 (0.500") +0.012/+0.038 (mm)	15.875 +0.051/+0.076	7.938 +/-0.127	BP0127-0159-0079-BSLH
12.700 (0.500") +0.013/+0.038 (mm)	15.875 +0.051/+0.076	9.525 +/-0.127	BP0127-0159-0095-BSLH
12.700 (0.500") +0.025/+0.051 (mm)	15.875 +0.051/+0.076	9.525 +/-0.127	BP0127-0159-0095-BSTH
12.700 (0.500") +0.051/+0.076 (mm)	15.875 +0.051/+0.076	10.617 +0/-0.102	BP0127-0159-0106-BSHH
12.700 (0.500") +0.013/+0.038 (mm)	15.875 +0.051/+0.076	11.100 +/-0.127	BP0127-0159-0111-BSLH
12.700 (0.500") +0.051/+0.076 (mm)	15.875 +0.051/+0.076	11.100 +/-0.127	BP0127-0159-0111-BSHH
12.700 (0.500") +0.025/+0.051 (mm)	15.875 +0.051/+0.076	12.700 +/-0.127	BP0127-0159-0127-BSTH
12.700 (0.500") +0.012/+0.038 (mm)	15.875 +0.051/+0.076	12.700 +/-0.127	BP0127-0159-0127-BSLH
12.700 (0.500") +0.038/+0.063 (mm)	15.875 +0.076/+0.102	12.700 +/-0.127	BP0127-0159-0127-BSHH1
12.700 (0.500") +0.076/+0.102 (mm)	15.875 +0.038/+0.063	12.700 +/-0.127	BP0127-0159-0127-BSHH2
12.700 (0.500") +0.012/+0.038 (mm)	15.875 +0.051/+0.076	14.288 +/-0.127	BP0127-0159-0143-BSLH

Stocked or Short Delivery

Usually Available Short Delivery

Long delivery or not in current production

* Large Minimum Quantities

** Available only while stock last:

Bushes - Plain

Nominal ID (d) mm (inches)	Nominal OD (D) mm	Length (S) mm	Part Number
12.700 (0.500") +0.051/+0.076 (mm)	15.875 +0.051/+0.076	15.062 +/-0.127	BP0127-0159-0151-BSHH
12.700 (0.500") +0.038/+0.063 (mm)	15.875 +0.076/+0.102	15.875 +/-0.127	BP0127-0159-0159-BSHH
12.700 (0.500") +0.012/+0.038 (mm)	15.875 +0.051/+0.076	15.875 +/-0.127	BP0127-0159-0159-BSLH
12.700 (0.500") +0.025/+0.051 (mm)	15.875 +0.051/+0.076	15.875 +/-0.127	BP0127-0159-0159-BSTH
12.700 (0.500") +0.012/+0.038 (mm)	15.875 +0.051/+0.076	17.463 +/-0.127	BP0127-0159-0175-BSLH
12.700 (0.500") +0.025/+0.051 (mm)	15.875 +0.051/+0.076	19.050 +/-0.127	BP0127-0159-0191-BSTH
12.700 (0.500") +0.038/+0.063 (mm)	15.875 +0.076/+0.102	19.050 +/-0.127	BP0127-0159-0191-BSHH
12.700 (0.500") +0.012/+0.038 (mm)	15.875 +0.051/+0.076	19.050 +/-0.127	BP0127-0159-0191-BSLH
12.700 (0.500") +0.013/+0.038 (mm)	15.875 +0.051/+0.076	22.225	BP0127-0159-0222-BSLH
12.700 (0.500") +0.025/+0.051 (mm)	15.875 +0.051/+0.076	22.225 +/-0.127	BP0127-0159-0222-BSTH
12.700 (0.500") +0.038/+0.063 (mm)	15.875 +0.076/+0.102	25.400 +/-0.127	BP0127-0159-0254-BSHH1
12.700 (0.500") +0.076/+0.102 (mm)	15.875 +0.038/+0.063	25.400 +/-0.127	BP0127-0159-0254-BSHH2
12.700 (0.500") +0.012/+0.038 (mm)	15.875 +0.051/+0.076	25.400 +/-0.127	BP0127-0159-0254-BSLH
12.700 (0.500") +0.025/+0.051 (mm)	15.875 +0.051/+0.076	25.400 +/-0.127	BP0127-0159-0254-BSTH
12.700 (0.500") +0.051/+0.076 (mm)	15.875 +0.051/+0.076	26.162 +/-0.127	BP0127-0159-0262-BSHH
12.700 (0.500") +0.025/+0.051 (mm)	15.875 +0.051/+0.076	28.575 +/-0.127	BP0127-0159-0286-BSTH
12.700 (0.500") +0.025/+0.051 (mm)	15.875 +0.051/+0.076	31.750 +/-0.127	BP0127-0159-0318-BSTH
12.700 (0.500") +0.038/+0.063 (mm)	15.875 +0.076/+0.102	31.750 +/-0.127	BP0127-0159-0318-BSHH
12.700 (0.500") +0.012/+0.038 (mm)	15.875 +0.051/+0.076	31.750 +/-0.127	BP0127-0159-0318-BSLH
12.700 (0.500") +0.012/+0.038 (mm)	15.875 +0.051/+0.076	38.100 +/-0.127	BP0127-0159-0381-BSLH
12.700 (0.500") +0.076/+0.102 (mm)	17.463 +0.038/+0.063	6.350 +/-0.127	BP0127-0175-0064-BSHH
12.700 (0.500") +0.012/+0.038 (mm)	17.463 +0.038/+0.063	9.525 +/-0.127	BP0127-0175-0095-BSLH
12.700 (0.500") +0.051/+0.076 (mm)	17.463 +0.051/+0.076	12.700 +/-0.127	BP0127-0175-0127-BSHH1
12.700 (0.500") +0.076/+0.102 (mm)	17.463 +0.038/+0.063	12.700 +/-0.127	BP0127-0175-0127-BSHH2
12.700 (0.500") +0.012/+0.038 (mm)	17.463 +0.038/+0.063	12.700 +/-0.127	BP0127-0175-0127-BSLH
12.700 (0.500") +0.076/+0.102 (mm)	17.463 +0.038/+0.063	14.288 +/-0.127	BP0127-0175-0143-BSHH
12.700 (0.500") +0.012/+0.038 (mm)	17.463 +0.038/+0.063	14.288 +/-0.127	BP0127-0175-0143-BSLH
12.700 (0.500") +0.051/+0.076 (mm)	17.463 +0.051/+0.076	15.875 +/-0.127	BP0127-0175-0159-BSHH1
12.700 (0.500") +0.076/+0.102 (mm)	17.463 +0.038/+0.063	15.875 +/-0.127	BP0127-0175-0159-BSHH2
12.700 (0.500") +0.012/+0.038 (mm)	17.463 +0.038/+0.063	15.875 +/-0.127	BP0127-0175-0159-BSLH
12.700 (0.500") +0.076/+0.102 (mm)	17.463 +0.038/+0.063	19.050 +/-0.127	BP0127-0175-0191-BSHH
12.700 (0.500") +0.038/+0.063 (mm)	17.463 +0.012/+0.038	19.050 +/-0.127	BP0127-0175-0191-BSHL
12.700 (0.500") +0.012/+0.038 (mm)	17.463 +0.038/+0.063	19.050 +/-0.127	BP0127-0175-0191-BSLH
12.700 (0.500") +0.012/+0.038 (mm)	17.463 +0.038/+0.063	22.225 +/-0.127	BP0127-0175-0222-BSLH

Stocked or Short Delivery

Usually Available Short Delivery

Long delivery or not in current production

* Large Minimum Quantities

** Available only while stock last:

Bushes - Plain

Nominal ID (d) mm (inches)	Nominal OD (D) mm	Length (S) mm	Part Number
12.700 (0.500")	17.463	22.225	BP0127-0175-0222-BSHH1
+0.051/+0.076 (mm)	+0.051/+0.076	+/-0.127	
12.700 (0.500")	17.463	22.225	BP0127-0175-0222-BSHH2
+0.076/+0.102 (mm)	+0.038/+0.063	+/-0.127	
12.700 (0.500")	17.463	25.400	BP0127-0175-0254-BSLH
+0.012/+0.038 (mm)	+0.038/+0.063	+/-0.127	
12.700 (0.500")	17.463	25.400	BP0127-0175-0254-BSHH1
+0.051/+0.076 (mm)	+0.051/+0.076	+/-0.127	
12.700 (0.500")	17.463	25.400	BP0127-0175-0254-BSHH2
+0.076/+0.102 (mm)	+0.038/+0.063	+/-0.127	
12.700 (0.500")	17.463	28.575	BP0127-0175-0286-BSHH1
+0.051/+0.076 (mm)	+0.051/+0.076	+/-0.127	
12.700 (0.500")	17.463	28.575	BP0127-0175-0286-BSHH2
+0.076/+0.102 (mm)	+0.038/+0.063	+/-0.127	
12.700 (0.500")	17.463	28.575	BP0127-0175-0286-BSLH
+0.012/+0.038 (mm)	+0.038/+0.063	+/-0.127	
12.700 (0.500")	17.463	28.575	BP0127-0175-0286-BSTH
+0.025/+0.051 (mm)	+0.025/+0.076	+/-0.397	
12.700 (0.500")	17.463	31.750	BP0127-0175-0318-BSLH
+0.012/+0.038 (mm)	+0.038/+0.063	+/-0.127	
12.700 (0.500")	17.463	31.750	BP0127-0175-0318-BSHH
+0.051/+0.076 (mm)	+0.051/+0.076	+/-0.127	
12.700 (0.500")	17.463	31.750	BP0127-0175-0318-BSHL
+0.038/+0.063 (mm)	+0.012/+0.038	+/-0.127	
12.700 (0.500")	17.463	34.925	BP0127-0175-0349-BSHH
+0.076/+0.102 (mm)	+0.038/+0.063	+/-0.127	
12.700 (0.500")	17.463	38.100	BP0127-0175-0381-BSHH
+0.051/+0.076 (mm)	+0.051/+0.076	+/-0.127	
12.700 (0.500")	17.463	38.100	BP0127-0175-0381-BSLL
+0.013/+0.038 (mm)	+0.013/+0.038		
12.700 (0.500")	19.050	6.350	BP0127-0191-0064-BSHH
+0.051/+0.076 (mm)	+0.051/+0.076	+/-0.127	
12.700 (0.500")	19.050	9.525	BP0127-0191-0095-BSTH
+0.025/+0.051 (mm)	+0.051/+0.076	+/-0.127	
12.700 (0.500")	19.050	11.100	BP0127-0191-0111-BSHH
+0.051/+0.076 (mm)	+0.063/+0.089	+0/-0.203	
12.700 (0.500")	19.050	12.700	BP0127-0191-0127-BSUT
-0.013/+0.013 (mm)	+0.025/+0.051	+/-0.127	
12.700 (0.500")	19.050	12.700	BP0127-0191-0127-BSHH
+0.038/+0.063 (mm)	+0.051/+0.076	+/-0.127	
12.700 (0.500")	19.050	12.700	BP0127-0191-0127-BSLT
+0.012/+0.038 (mm)	+0.025/+0.051	+/-0.127	
12.700 (0.500")	19.050	12.700	BP0127-0191-0127-BSTH
+0.025/+0.051 (mm)	+0.051/+0.076	+/-0.127	
12.700 (0.500")	19.050	14.288	BP0127-0191-0143-BSLT
+0.012/+0.038 (mm)	+0.025/+0.051	+/-0.127	
12.700 (0.500")	19.050	15.875	BP0127-0191-0159-BSTH
+0.025/+0.051 (mm)	+0.051/+0.076	+/-0.127	
12.700 (0.500")	19.050	15.875	BP0127-0191-0159-BSHH
+0.038/+0.063 (mm)	+0.051/+0.076	+/-0.127	
12.700 (0.500")	19.050	19.050	BP0127-0191-0191-BSHH
+0.038/+0.063 (mm)	+0.051/+0.076	+/-0.127	
12.700 (0.500")	19.050	19.050	BP0127-0191-0191-BSLT
+0.012/+0.038 (mm)	+0.025/+0.051	+/-0.127	
12.700 (0.500")	19.050	19.050	BP0127-0191-0191-BSTH
+0.025/+0.051 (mm)	+0.051/+0.076	+/-0.127	
12.700 (0.500")	19.050	19.050	BP0127-0191-0191-BSUT
-0.013/+0.013 (mm)	+0.025/+0.051	+/-0.127	
12.700 (0.500")	19.050	22.225	BP0127-0191-0222-BSHH
+0.038/+0.063 (mm)	+0.051/+0.076	+/-0.127	
12.700 (0.500")	19.050	22.225	BP0127-0191-0222-BSTH
+0.025/+0.051 (mm)	+0.051/+0.076	+/-0.127	
12.700 (0.500")	19.050	25.400	BP0127-0191-0254-BSLT
+0.012/+0.038 (mm)	+0.025/+0.051	+/-0.127	
12.700 (0.500")	19.050	25.400	BP0127-0191-0254-BSTH
+0.025/+0.051 (mm)	+0.051/+0.076	+/-0.127	
12.700 (0.500")	19.050	25.400	BP0127-0191-0254-BSUT
-0.013/+0.013 (mm)	+0.025/+0.051	+/-0.127	

Stocked or Short Delivery

Usually Available Short Delivery

Long delivery or not in current production

* Large Minimum Quantities

** Available only while stock last:

Bushes - Plain

Nominal ID (d) mm (inches)	Nominal OD (D) mm	Length (S) mm	Part Number
12.700 (0.500") +0.038/+0.063 (mm)	19.050 +0.051/+0.076	25.400 +/-0.127	BP0127-0191-0254-BSHH
12.700 (0.500") +0.051/+0.076 (mm)	19.050 +0.051/+0.076	28.575 +/-0.127	BP0127-0191-0286-BSHH
12.700 (0.500") +0.025/+0.051 (mm)	19.050 +0.025/+0.076	28.575 +/-0.397	BP0127-0191-0286-BSTH
12.700 (0.500") -0.013/+0.013 (mm)	19.050 +0.025/+0.051	28.575 +/-0.127	BP0127-0191-0286-BSUT
12.700 (0.500") +0.038/+0.063 (mm)	19.050 +0.051/+0.076	31.750 +/-0.127	BP0127-0191-0318-BSHH
12.700 (0.500") +0.025/+0.051 (mm)	19.050 +0.051/+0.076	31.750 +/-0.127	BP0127-0191-0318-BSTH
12.700 (0.500") -0.013/+0.013 (mm)	19.050 +0.025/+0.051	31.750 +/-0.127	BP0127-0191-0318-BSUT
12.700 (0.500") +0.012/+0.038 (mm)	19.050 +0.025/+0.051	38.100 +/-0.127	BP0127-0191-0381-BSLT
12.700 (0.500") +0.025/+0.051 (mm)	19.050 +0.051/+0.076	38.100 +/-0.127	BP0127-0191-0381-BSTH
12.700 (0.500") +0.038/+0.063 (mm)	19.050 +0.051/+0.076	38.100 +/-0.127	BP0127-0191-0381-BSHH
12.700 (0.500") +0.025/+0.051 (mm)	19.050 +0.051/+0.076	44.450 +/-0.190	BP0127-0191-0445-BSTH
12.700 (0.500") +0.038/+0.063 (mm)	19.050 +0.051/+0.076	44.450 +/-0.190	BP0127-0191-0445-BSHH
12.700 (0.500") +0.051/+0.076 (mm)	19.050 +0.051/+0.076	50.800 +/-0.190	BP0127-0191-0508-BSHH
12.700 (0.500") +0.025/+0.051 (mm)	19.050 +0.051/+0.076	50.800 +/-0.190	BP0127-0191-0508-BSTH
12.700 (0.500") +0.051/+0.076 (mm)	20.638 +0.038/+0.063	12.700 +/-0.127	BP0127-0206-0127-BSHH
12.700 (0.500") +0.025/+0.051 (mm)	20.638 +0.076/+0.102	12.700 +/-0.127	BP0127-0206-0127-BSTH
12.700 (0.500") +0.051/+0.076 (mm)	20.638 +0.038/+0.063	19.050 +/-0.127	BP0127-0206-0191-BSHH
12.700 (0.500") +0.000/+0.025 (mm)	20.638 +0.038/+0.063	19.050 +/-0.127	BP0127-0206-0191-BSLH
12.700 (0.500") +0.025/+0.051 (mm)	20.638 +0.076/+0.102	19.050 +/-0.127	BP0127-0206-0191-BSTH
12.700 (0.500") +0.051/+0.076 (mm)	20.638 +0.038/+0.063	25.400 +/-0.127	BP0127-0206-0254-BSHH
12.700 (0.500") +0.025/+0.051 (mm)	20.638 +0.076/+0.102	25.400 +/-0.127	BP0127-0206-0254-BSTH
12.700 (0.500") +0.000/+0.025 (mm)	20.638 +0.038/+0.063	25.400 +/-0.127	BP0127-0206-0254-BSLH
12.700 (0.500") +0.051/+0.076 (mm)	20.638 +0.038/+0.063	38.100 +/-0.127	BP0127-0206-0381-BSHH
12.700 (0.500") +0.000/+0.025 (mm)	20.638 +0.038/+0.063	38.100 +/-0.127	BP0127-0206-0381-BSLH
12.700 (0.500") +0.025/+0.051 (mm)	20.638 +0.076/+0.102	38.100 +/-0.127	BP0127-0206-0381-BSTH
12.700 (0.500") +0.051/+0.076 (mm)	22.225 +0.051/+0.076	12.700 +/-0.127	BP0127-0222-0127-BSHH1
12.700 (0.500") +0.051/+0.076 (mm)	22.225 +0.076/+0.102	12.700 +/-0.127	BP0127-0222-0127-BSHH2
12.700 (0.500") +0.051/+0.076 (mm)	22.225 +0.051/+0.076	15.875 +/-0.127	BP0127-0222-0159-BSHH
12.700 (0.500") +0.025/+0.051 (mm)	22.225 +0.076/+0.102	15.875	BP0127-0222-0159-BSTH
12.700 (0.500") +0.051/+0.076 (mm)	22.225 +0.051/+0.076	19.050 +/-0.127	BP0127-0222-0191-BSHH1
12.700 (0.500") +0.051/+0.076 (mm)	22.225 +0.076/+0.101	19.050 +/-0.127	BP0127-0222-0191-BSHH2
12.700 (0.500") +0.025/+0.051 (mm)	22.225 +0.076/+0.102	19.050	BP0127-0222-0191-BSTH
12.700 (0.500") +0.051/+0.076 (mm)	22.225 +0.051/+0.076	22.225 +/-0.127	BP0127-0222-0223-BSHH
12.700 (0.500") +0.025/+0.051 (mm)	22.225 +0.076/+0.102	22.225	BP0127-0222-0223-BSTH

 Stocked or Short Delivery

 Usually Available Short Delivery

 Long delivery or not in current production

* Large Minimum Quantities

** Available only while stock last:

Bushes - Plain

Nominal ID (d) mm (inches)	Nominal OD (D) mm	Length (S) mm	Part Number
12.700 (0.500")	22.225	25.400	BP0127-0222-0254-BSHH1
+0.051/+0.076 (mm)	+0.051/+0.076	+/-0.127	
12.700 (0.500")	22.225	25.400	BP0127-0222-0254-BSHH2
+0.051/+0.076 (mm)	+0.076/+0.101	+/-0.127	
12.700 (0.500")	22.225	25.400	BP0127-0222-0254-BSTH
+0.025/+0.051 (mm)	+0.076/+0.102		
12.700 (0.500")	22.225	31.750	BP0127-0222-0318-BSTH
+0.025/+0.051 (mm)	+0.076/+0.102		
12.700 (0.500")	22.225	31.750	BP0127-0222-0318-BSHH1
+0.051/+0.076 (mm)	+0.051/+0.076	+/-0.127	
12.700 (0.500")	22.225	31.750	BP0127-0222-0318-BSHH2
+0.051/+0.076 (mm)	+0.076/+0.101	+/-0.127	
12.700 (0.500")	22.225	38.100	BP0127-0222-0381-BSTH
+0.025/+0.051 (mm)	+0.076/+0.102		
12.700 (0.500")	22.225	38.100	BP0127-0222-0381-BSHH1
+0.051/+0.076 (mm)	+0.051/+0.076	+/-0.127	
12.700 (0.500")	22.225	38.100	BP0127-0222-0381-BSHH2
+0.051/+0.076 (mm)	+0.076/+0.101	+/-0.127	
12.700 (0.500")	25.400	19.050	BP0127-0254-0191-BSHH
+0.051/+0.076 (mm)	+0.076/+0.102	+/-0.127	
12.700 (0.500")	25.400	19.050	BP0127-0254-0191-BSTH
+0.025/+0.051 (mm)	+0.076/+0.102		
12.700 (0.500")	25.400	25.400	BP0127-0254-0254-BSHH
+0.051/+0.076 (mm)	+0.076/+0.102	+/-0.127	
12.700 (0.500")	25.400	25.400	BP0127-0254-0254-BSTH
+0.025/+0.051 (mm)	+0.076/+0.102		
12.700 (0.500")	25.400	38.100	BP0127-0254-0381-BSHH
+0.051/+0.076 (mm)	+0.076/+0.102	+/-0.127	
12.700 (0.500")	25.400	38.100	BP0127-0254-0381-BSTH
+0.025/+0.051 (mm)	+0.076/+0.102		
12.700 (0.500")	25.400	50.800	BP0127-0254-0508-BSTH
+0.025/+0.051 (mm)	+0.076/+0.102		
12.700 (0.500")	25.400	50.800	BP0127-0254-0508-BSHH
+0.051/+0.076 (mm)	+0.076/+0.102	+/-0.190	
12.700 (0.500")	28.575	7.938	BP0127-0286-0079-BSLU
+0.000/+0.010 (mm)	-0.010/+0.003	+0/-0.127	
14.000 (0.551")	18.000	10.000	BP0140-0180-0100-BS
+0.005/+0.030 (mm)	+0.028/+0.050	+/-0.127	
14.000 (0.551")	18.000	14.000	BP0140-0180-0140-BS
+0.005/+0.030 (mm)	+0.028/+0.050	+/-0.127	
14.000 (0.551")	18.000	15.000	BP0140-0180-0150-BS
+0.005/+0.030 (mm)	+0.028/+0.050	+/-0.120	
14.000 (0.551")	18.000	18.000	BP0140-0180-0180-BS
+0.005/+0.030 (mm)	+0.028/+0.050	+/-0.120	
14.000 (0.551")	18.000	19.000	BP0140-0180-0190-BS
+0.005/+0.030 (mm)	+0.028/+0.050	+/-0.120	
14.000 (0.551")	18.000	20.000	BP0140-0180-0200-BS
+0.005/+0.030 (mm)	+0.028/+0.050	+/-0.127	
14.000 (0.551")	18.000	22.000	BP0140-0180-0220-BS
+0.005/+0.030 (mm)	+0.028/+0.050	+/-0.120	
14.000 (0.551")	18.000	26.000	BP0140-0180-0260-BS
+0.005/+0.030 (mm)	+0.028/+0.050	+/-0.120	
14.000 (0.551")	18.000	28.000	BP0140-0180-0280-BS
+0.005/+0.030 (mm)	+0.028/+0.050	+/-0.120	
14.000 (0.551")	20.000	10.000	BP0140-0200-0100-BSLT
+0.005/+0.030 (mm)	+0.035/+0.060	+/-0.127	
14.000 (0.551")	20.000	12.000	BP0140-0200-0120-BS
+0.005/+0.030 (mm)	+0.035/+0.060	+/-0.120	
14.000 (0.551")	20.000	14.000	BP0140-0200-0140-BS
+0.005/+0.030 (mm)	+0.035/+0.060	+/-0.127	
14.000 (0.551")	20.000	15.000	BP0140-0200-0150-BS
+0.005/+0.030 (mm)	+0.035/+0.060	+/-0.120	
14.000 (0.551")	20.000	18.000	BP0140-0200-0180-BS
+0.005/+0.030 (mm)	+0.035/+0.060	+/-0.120	
14.000 (0.551")	20.000	20.000	BP0140-0200-0200-BS
+0.005/+0.030 (mm)	+0.035/+0.060	+/-0.127	
14.000 (0.551")	20.000	22.000	BP0140-0200-0220-BS
+0.005/+0.030 (mm)	+0.035/+0.060	+/-0.120	

Stocked or Short Delivery

Usually Available Short Delivery

Long delivery or not in current production

* Large Minimum Quantities

** Available only while stock last:

Bushes - Plain

Nominal ID (d) mm (inches)	Nominal OD (D) mm	Length (S) mm	Part Number
14.000 (0.551") +0.005/+0.030 (mm)	20.000 +0.035/+0.060	25.000 +/-0.120	BP0140-0200-0250-BS
14.000 (0.551") +0.005/+0.030 (mm)	20.000 +0.035/+0.060	28.000 +/-0.120	BP0140-0200-0280-BS
14.000 (0.551") +0.025/+0.051 (mm)	20.000 +0.035/+0.056	30.000 +/-0.127	BP0140-0200-0300-BS
14.288 (0.563") +0.000/+0.025 (mm)	17.463 +0.063/+0.089	11.113 +/-0.127	BP0143-0175-0111-BSLH
14.288 (0.563") +0.038/+0.063 (mm)	17.463 +0.038/+0.063	12.700 +/-0.127	BP0143-0175-0127-BSHH
14.288 (0.563") +0.025/+0.051 (mm)	17.463 +0.051/+0.076	12.700 +/-0.127	BP0143-0175-0127-BSTH
14.288 (0.563") +0.000/+0.025 (mm)	17.463 +0.063/+0.089	12.700 +/-0.127	BP0143-0175-0127-BSLH
14.288 (0.563") +0.000/+0.025 (mm)	17.463 +0.063/+0.089	15.875 +/-0.127	BP0143-0175-0159-BSLH
14.288 (0.563") +0.025/+0.051 (mm)	17.463 +0.051/+0.076	15.875 +/-0.127	BP0143-0175-0159-BSTH
14.288 (0.563") +0.038/+0.063 (mm)	17.463 +0.038/+0.063	19.050 +/-0.127	BP0143-0175-0191-BSHH
14.288 (0.563") +0.000/+0.025 (mm)	17.463 +0.063/+0.089	19.050 +/-0.127	BP0143-0175-0191-BSLH
14.288 (0.563") +0.025/+0.051 (mm)	17.463 +0.051/+0.076	19.050 +/-0.127	BP0143-0175-0191-BSTH
14.288 (0.563") +0.025/+0.051 (mm)	17.463 +0.051/+0.076	25.400 +/-0.127	BP0143-0175-0254-BSTH
14.288 (0.563") +0.038/+0.063 (mm)	17.463 +0.038/+0.063	25.400 +/-0.127	BP0143-0175-0254-BSHH
14.288 (0.563") +0.000/+0.025 (mm)	17.463 +0.063/+0.089	25.400 +/-0.127	BP0143-0175-0254-BSLH
14.288 (0.563") +0.114/+0.140 (mm)	17.463 +0.012/+0.038	28.575 +/-0.127	BP0143-0175-0286-BSHL
14.288 (0.563") +0.000/+0.025 (mm)	17.463 +0.063/+0.089	31.750 +/-0.127	BP0143-0175-0318-BSLH
14.288 (0.563") +0.025/+0.051 (mm)	17.463 +0.051/+0.076	31.750 +/-0.127	BP0143-0175-0318-BSTH
14.288 (0.563") +0.038/+0.063 (mm)	17.463 +0.038/+0.063	31.750 +/-0.127	BP0143-0175-0318-BSHH
14.288 (0.563") +0.038/+0.063 (mm)	17.463 +0.038/+0.063	38.100 +/-0.127	BP0143-0175-0381-BSHH
14.288 (0.563") +0.114/+0.140 (mm)	17.463 +0.012/+0.038	38.100 +/-0.127	BP0143-0175-0381-BSHL
14.288 (0.563") +0.025/+0.051 (mm)	17.463 +0.051/+0.076	38.100 +/-0.127	BP0143-0175-0381-BSTH
14.288 (0.563") +0.012/+0.038 (mm)	19.050 +0.051/+0.076	12.700 +/-0.127	BP0143-0191-0127-BSL2H
14.288 (0.563") +0.038/+0.063 (mm)	19.050 +0.051/+0.076	12.700 +/-0.127	BP0143-0191-0127-BSHH1
14.288 (0.563") +0.063/+0.088 (mm)	19.050 +0.051/+0.076	12.700 +/-0.127	BP0143-0191-0127-BSHH2
14.288 (0.563") +0.000/+0.025 (mm)	19.050 +0.063/+0.089	12.700 +/-0.127	BP0143-0191-0127-BSL1H
14.288 (0.563") +0.000/+0.025 (mm)	19.050 +0.063/+0.089	15.875 +/-0.127	BP0143-0191-0159-BSLH
14.288 (0.563") +0.063/+0.088 (mm)	19.050 +0.051/+0.076	19.050 +/-0.127	BP0143-0191-0191-BSHH
14.288 (0.563") +0.000/+0.025 (mm)	19.050 +0.063/+0.089	19.050 +/-0.127	BP0143-0191-0191-BSL1H
14.288 (0.563") +0.012/+0.038 (mm)	19.050 +0.051/+0.076	19.050 +/-0.127	BP0143-0191-0191-BSL2H
14.288 (0.563") +0.025/+0.051 (mm)	19.050 +0.051/+0.076	19.050 +/-0.127	BP0143-0191-0191-BSTH
14.288 (0.563") +0.038/+0.063 (mm)	19.050 +0.051/+0.076	25.400 +/-0.127	BP0143-0191-0254-BSHH1
14.288 (0.563") +0.063/+0.088 (mm)	19.050 +0.051/+0.076	25.400 +/-0.127	BP0143-0191-0254-BSHH2
14.288 (0.563") +0.000/+0.025 (mm)	19.050 +0.063/+0.089	25.400 +/-0.127	BP0143-0191-0254-BSL1H

 Stocked or Short Delivery

 Usually Available Short Delivery

 Long delivery or not in current production

* Large Minimum Quantities

** Available only while stock last:

Bushes - Plain

Nominal ID (d) mm (inches)	Nominal OD (D) mm	Length (S) mm	Part Number
14.288 (0.563") +0.012/+0.038 (mm)	19.050 +0.051/+0.076	25.400 +/-0.127	BP0143-0191-0254-BSL2H
14.288 (0.563") +0.063/+0.088 (mm)	19.050 +0.051/+0.076	31.750 +/-0.127	BP0143-0191-0318-BSHH
14.288 (0.563") +0.025/+0.051 (mm)	19.050 +0.051/+0.076	31.750 +/-0.127	BP0143-0191-0318-BSH
14.288 (0.563") +0.000/+0.025 (mm)	19.050 +0.063/+0.089	31.750 +/-0.127	BP0143-0191-0318-BSL1H
14.288 (0.563") +0.012/+0.038 (mm)	19.050 +0.051/+0.076	31.750 +/-0.127	BP0143-0191-0318-BSL2H
14.288 (0.563") +0.000/+0.025 (mm)	19.050 +0.063/+0.089	34.925 +/-0.127	BP0143-0191-0349-BSLH
14.288 (0.563") +0.038/+0.063 (mm)	19.050 +0.051/+0.076	38.100 +/-0.127	BP0143-0191-0381-BSHH1
14.288 (0.563") +0.063/+0.088 (mm)	19.050 +0.051/+0.076	38.100 +/-0.127	BP0143-0191-0381-BSHH2
14.288 (0.563") +0.000/+0.025 (mm)	19.050 +0.063/+0.089	38.100 +/-0.127	BP0143-0191-0381-BSLH
14.288 (0.563") +0.038/+0.063 (mm)	20.638 +0.038/+0.063	12.700 +/-0.127	BP0143-0206-0127-BSHH
14.288 (0.563") +0.038/+0.063 (mm)	20.638 +0.038/+0.063	19.050 +/-0.127	BP0143-0206-0191-BSHH1
14.288 (0.563") -0.013/+0.013 (mm)	20.638 +0.038/+0.064	19.050 +/-0.127	BP0143-0206-0191-BSHH2
14.288 (0.563") +0.038/+0.063 (mm)	20.638 +0.038/+0.063	25.400 +/-0.127	BP0143-0206-0254-BSHH1
14.288 (0.563") -0.013/+0.013 (mm)	20.638 +0.038/+0.064	25.400 +/-0.127	BP0143-0206-0254-BSHH2
14.288 (0.563") +0.038/+0.063 (mm)	20.638 +0.038/+0.063	31.750 +/-0.127	BP0143-0206-0318-BSHH1
14.288 (0.563") -0.013/+0.013 (mm)	20.638 +0.038/+0.064	31.750 +/-0.127	BP0143-0206-0318-BSHH2
14.288 (0.563") +0.038/+0.063 (mm)	20.638 +0.038/+0.063	38.100 +/-0.127	BP0143-0206-0381-BSHH
14.288 (0.563") +0.088/+0.114 (mm)	22.225 +0.025/+0.051	25.400 +/-0.127	BP0143-0222-0254-BSHT
14.288 (0.563") +0.088/+0.114 (mm)	22.225 +0.025/+0.051	34.925 +/-0.127	BP0143-0222-0349-BSHT
15.000 (0.591") +0.005/+0.030 (mm)	19.000 +0.035/+0.060	10.000 +/-0.127	BP0150-0190-0100-BS
15.000 (0.591") +0.005/+0.030 (mm)	19.000 +0.035/+0.060	15.000 +/-0.127	BP0150-0190-0150-BS
15.000 (0.591") +0.005/+0.030 (mm)	19.000 +0.035/+0.060	16.000 +/-0.120	BP0150-0190-0160-BS
15.000 (0.591") +0.005/+0.030 (mm)	19.000 +0.035/+0.060	25.000 +/-0.127	BP0150-0190-0250-BS
15.000 (0.591") +0.025/+0.051 (mm)	19.000 +0.035/+0.056	30.000 +/-0.127	BP0150-0190-0300-BS
15.000 (0.591") +0.005/+0.030 (mm)	19.000 +0.035/+0.060	32.000 +/-0.120	BP0150-0190-0320-BS
15.000 (0.591") +0.005/+0.030 (mm)	21.000 +0.035/+0.060	10.000 +/-0.120	BP0150-0210-0100-BS
15.000 (0.591") +0.005/+0.030 (mm)	21.000 +0.035/+0.060	15.000 +/-0.127	BP0150-0210-0150-BS
15.000 (0.591") +0.005/+0.030 (mm)	21.000 +0.035/+0.060	16.000 +/-0.120	BP0150-0210-0160-BS
15.000 (0.591") +0.005/+0.030 (mm)	21.000 +0.035/+0.060	20.000 +/-0.120	BP0150-0210-0200-BS
15.000 (0.591") +0.005/+0.030 (mm)	21.000 +0.035/+0.060	21.000 +/-0.120	BP0150-0210-0210-BS
15.000 (0.591") +0.005/+0.030 (mm)	21.000 +0.035/+0.060	25.000 +/-0.127	BP0150-0210-0250-BS
15.000 (0.591") +0.005/+0.030 (mm)	21.000 +0.035/+0.060	30.000 +/-0.120	BP0150-0210-0300-BS
15.000 (0.591") +0.005/+0.030 (mm)	21.000 +0.035/+0.060	32.000 +/-0.120	BP0150-0210-0320-BS
15.875 (0.625") +0.051/+0.076 (mm)	19.050 +0.051/+0.076	8.712 +/-0.127	BP0159-0191-0087-BSHH

Stocked or Short Delivery

Usually Available Short Delivery

Long delivery or not in current production

* Large Minimum Quantities

** Available only while stock last:

Bushes - Plain

Nominal ID (d) mm (inches)	Nominal OD (D) mm	Length (S) mm	Part Number
15.875 (0.625") +0.051/+0.076 (mm)	19.050 +0.063/+0.089	9.525 +/-0.127	BP0159-0191-0095-BSHH
15.875 (0.625") +0.025/+0.051 (mm)	19.050 +0.051/+0.076	9.525 +/-0.127	BP0159-0191-0095-BSTH
15.875 (0.625") +0.051/+0.076 (mm)	19.050 +0.063/+0.089	11.049 +/-0.127	* BP0159-0191-0110-BSHH
15.875 (0.625") +0.025/+0.051 (mm)	19.050 +0.051/+0.076	12.700 +/-0.127	BP0159-0191-0127-BSTH
15.875 (0.625") +0.025/+0.051 (mm)	19.050 +0.025/+0.051	12.700	BP0159-0191-0127-BS
15.875 (0.625") +0.051/+0.076 (mm)	19.050 +0.051/+0.076	12.700 +/-0.127	BP0159-0191-0127-BSHH
15.875 (0.625") +0.000/+0.025 (mm)	19.050 +0.051/+0.076	12.700 +/-0.127	BP0159-0191-0127-BSLH
15.875 (0.625") +0.025/+0.051 (mm)	19.050 +0.051/+0.076	15.875 +/-0.127	BP0159-0191-0159-BSTH
15.875 (0.625") +0.051/+0.076 (mm)	19.050 +0.051/+0.076	15.875 +/-0.127	BP0159-0191-0159-BSHH
15.875 (0.625") +0.025/+0.051 (mm)	19.050 +0.025/+0.051	15.875	BP0159-0191-0159-BS
15.875 (0.625") +0.025/+0.051 (mm)	19.050 +0.025/+0.051	19.050	BP0159-0191-0191-BS
15.875 (0.625") +0.051/+0.076 (mm)	19.050 +0.051/+0.076	19.050 +/-0.127	BP0159-0191-0191-BSHH
15.875 (0.625") +0.025/+0.051 (mm)	19.050 +0.051/+0.076	19.050 +/-0.127	BP0159-0191-0191-BSTH
15.875 (0.625") +0.051/+0.076 (mm)	19.050 +0.063/+0.089	19.329 +0/-0.127	BP0159-0191-0193-BSHH
15.875 (0.625") +0.051/+0.076 (mm)	19.050 +0.051/+0.076	22.225 +/-0.127	BP0159-0191-0222-BSHH
15.875 (0.625") +0.000/+0.025 (mm)	19.050 +0.051/+0.076	22.225 +/-0.127	BP0159-0191-0222-BSLH
15.875 (0.625") +0.025/+0.051 (mm)	19.050 +0.051/+0.076	22.225 +/-0.127	BP0159-0191-0222-BSTH
15.875 (0.625") +0.051/+0.076 (mm)	19.050 +0.051/+0.076	25.400 +/-0.127	BP0159-0191-0254-BSHH
15.875 (0.625") +0.000/+0.025 (mm)	19.050 +0.051/+0.076	25.400 +/-0.127	BP0159-0191-0254-BSLH
15.875 (0.625") +0.025/+0.051 (mm)	19.050 +0.051/+0.076	25.400 +/-0.127	BP0159-0191-0254-BSTH
15.875 (0.625") +0.051/+0.076 (mm)	19.050 +0.051/+0.076	28.575 +/-0.127	BP0159-0191-0286-BSHH
15.875 (0.625") +0.000/+0.025 (mm)	19.050 +0.051/+0.076	28.575 +/-0.127	BP0159-0191-0286-BSLH
15.875 (0.625") +0.025/+0.051 (mm)	19.050 +0.025/+0.076	28.575 +/-0.397	BP0159-0191-0286-BSTH
15.875 (0.625") +0.000/+0.025 (mm)	19.050 +0.051/+0.076	31.750 +/-0.127	BP0159-0191-0318-BSLH
15.875 (0.625") +0.025/+0.051 (mm)	19.050 +0.051/+0.076	31.750 +/-0.127	BP0159-0191-0318-BSTH
15.875 (0.625") +0.025/+0.051 (mm)	19.050 +0.051/+0.076	38.100 +/-0.127	BP0159-0191-0381-BSTH
15.875 (0.625") +0.051/+0.076 (mm)	19.050 +0.051/+0.076	38.100 +/-0.127	BP0159-0191-0381-BSHH
15.875 (0.625") +0.000/+0.025 (mm)	19.050 +0.051/+0.076	38.100 +/-0.127	BP0159-0191-0381-BSLH
15.875 (0.625") -0.025/+0.000 (mm)	20.638 +0.038/+0.063	12.700 +/-0.127	BP0159-0206-0127-BSUH
15.875 (0.625") +0.025/+0.051 (mm)	20.638 +0.076/+0.102	12.700 +/-0.127	BP0159-0206-0127-BSTH
15.875 (0.625") +0.051/+0.076 (mm)	20.638 +0.051/+0.076	15.875 +/-0.127	BP0159-0206-0159-BSHH
15.875 (0.625") +0.025/+0.051 (mm)	20.638 +0.076/+0.102	15.875 +/-0.127	BP0159-0206-0159-BSTH
15.875 (0.625") -0.025/+0.000 (mm)	20.638 +0.038/+0.063	15.875 +/-0.127	BP0159-0206-0159-BSUH
15.875 (0.625") +0.051/+0.076 (mm)	20.638 +0.051/+0.076	19.050 +/-0.127	BP0159-0206-0191-BSHH

Stocked or Short Delivery

Usually Available Short Delivery

Long delivery or not in current production

* Large Minimum Quantities

** Available only while stock last:

Bushes - Plain

Nominal ID (d) mm (inches)	Nominal OD (D) mm	Length (S) mm	Part Number
15.875 (0.625") +0.025/+0.051 (mm)	20.638 +0.038/+0.063	19.050 +/-0.127	BP0159-0206-0191-BSTH1
15.875 (0.625") +0.025/+0.051 (mm)	20.638 +0.076/+0.102	19.050 +/-0.127	BP0159-0206-0191-BSTH2
15.875 (0.625") -0.025/+0.000 (mm)	20.638 +0.038/+0.063	19.050 +/-0.127	BP0159-0206-0191-BSUH
15.875 (0.625") +0.051/+0.076 (mm)	20.638 +0.038/+0.063	22.225 +/-0.127	BP0159-0206-0222-BSHH
15.875 (0.625") +0.025/+0.051 (mm)	20.638 +0.076/+0.102	22.225 +/-0.127	BP0159-0206-0222-BSTH
15.875 (0.625") -0.025/+0.000 (mm)	20.638 +0.038/+0.063	22.225 +/-0.127	BP0159-0206-0222-BSUH
15.875 (0.625") +0.051/+0.076 (mm)	20.638 +0.051/+0.076	25.400	BP0159-0206-0254-BSHH
15.875 (0.625") +0.025/+0.051 (mm)	20.638 +0.038/+0.063	25.400 +/-0.127	BP0159-0206-0254-BSTH1
15.875 (0.625") +0.025/+0.051 (mm)	20.638 +0.076/+0.102	25.400 +/-0.127	BP0159-0206-0254-BSTH2
15.875 (0.625") -0.025/+0.000 (mm)	20.638 +0.038/+0.063	25.400 +/-0.127	BP0159-0206-0254-BSUH
15.875 (0.625") -0.025/+0.000 (mm)	20.638 +0.038/+0.063	28.575 +/-0.127	BP0159-0206-0286-BSUH
15.875 (0.625") -0.013/+0.013 (mm)	20.638 +0.051/+0.076	31.750	BP0159-0206-0318-BSUH
15.875 (0.625") +0.051/+0.076 (mm)	20.638 +0.051/+0.076	31.750 +/-0.127	BP0159-0206-0318-BSHH
15.875 (0.625") +0.025/+0.051 (mm)	20.638 +0.038/+0.063	31.750 +/-0.127	BP0159-0206-0318-BSTH1
15.875 (0.625") +0.025/+0.051 (mm)	20.638 +0.076/+0.102	31.750 +/-0.127	BP0159-0206-0318-BSTH2
15.875 (0.625") -0.025/+0.000 (mm)	20.638 +0.038/+0.063	34.925 +/-0.127	BP0159-0206-0349-BSUH
15.875 (0.625") +0.025/+0.051 (mm)	20.638 +0.038/+0.063	34.925 +/-0.127	BP0159-0206-0349-BSTH
15.875 (0.625") +0.051/+0.076 (mm)	20.638 +0.038/+0.063	38.100 +/-0.127	BP0159-0206-0381-BSHH
15.875 (0.625") +0.025/+0.051 (mm)	20.638 +0.038/+0.063	38.100 +/-0.127	BP0159-0206-0381-BSTH1
15.875 (0.625") +0.025/+0.051 (mm)	20.638 +0.076/+0.102	38.100 +/-0.127	BP0159-0206-0381-BSTH2
15.875 (0.625") -0.025/+0.000 (mm)	20.638 +0.038/+0.063	38.100 +/-0.127	BP0159-0206-0381-BSUH
15.875 (0.625") +0.051/+0.076 (mm)	20.638 +0.038/+0.063	44.450 +/-0.190	BP0159-0206-0445-BSHH
15.875 (0.625") +0.025/+0.051 (mm)	20.638 +0.038/+0.063	44.450 +/-0.190	BP0159-0206-0445-BSTH1
15.875 (0.625") +0.025/+0.051 (mm)	20.638 +0.076/+0.102	44.450 +/-0.190	BP0159-0206-0445-BSTH2
15.875 (0.625") +0.025/+0.051 (mm)	20.638 +0.038/+0.063	50.800 +/-0.190	BP0159-0206-0508-BSTH
15.875 (0.625") +0.051/+0.076 (mm)	22.225 +0.063/+0.089	8.204 +/-0.127	BP0159-0222-0082-BSHH
15.875 (0.625") +0.051/+0.076 (mm)	22.225 +0.063/+0.089	12.700 +/-0.127	BP0159-0222-0127-BSHH2
15.875 (0.625") +0.025/+0.051 (mm)	22.225 +0.076/+0.102	12.700 +/-0.127	BP0159-0222-0127-BSTH
15.875 (0.625") -0.025/+0.000 (mm)	22.225 +0.279/+0.305	12.700 +/-0.127	BP0159-0222-0127-BSUH
15.875 (0.625") +0.051/+0.076 (mm)	22.225 +0.051/+0.076	12.700 +/-0.127	BP0159-0222-0127-BSHH1
15.875 (0.625") +0.051/+0.076 (mm)	22.225 +0.051/+0.076	15.875 +/-0.127	BP0159-0222-0159-BSHH1
15.875 (0.625") +0.051/+0.076 (mm)	22.225 +0.063/+0.089	15.875 +/-0.127	BP0159-0222-0159-BSHH2
15.875 (0.625") +0.025/+0.051 (mm)	22.225 +0.076/+0.102	15.875 +/-0.127	BP0159-0222-0159-BSTH
15.875 (0.625") -0.025/+0.000 (mm)	22.225 +0.279/+0.305	19.050 +/-0.127	BP0159-0222-0191-BSUH

Stocked or Short Delivery

Usually Available Short Delivery

Long delivery or not in current production

* Large Minimum Quantities

** Available only while stock last:

Bushes - Plain

Nominal ID (d) mm (inches)	Nominal OD (D) mm	Length (S) mm	Part Number
15.875 (0.625")	22.225	19.050	BP0159-0222-0191-BSTH
+0.025/+0.051 (mm)	+0.076/+0.102	+/-0.127	
15.875 (0.625")	22.225	22.225	BP0159-0222-0222-BSTH
+0.025/+0.051 (mm)	+0.051/+0.076	+/-0.127	
15.875 (0.625")	22.225	22.225	BP0159-0222-0222-BSHH
+0.051/+0.076 (mm)	+0.051/+0.076	+/-0.127	
15.875 (0.625")	22.225	25.400	BP0159-0222-0254-BSTH
+0.025/+0.051 (mm)	+0.076/+0.102	+/-0.127	
15.875 (0.625")	22.225	25.400	BP0159-0222-0254-BSUH
-0.025/+0.000 (mm)	+0.279/+0.305	+/-0.127	
15.875 (0.625")	22.225	28.575	BP0159-0222-0286-BSHH
+0.051/+0.076 (mm)	+0.051/+0.076	+/-0.127	
15.875 (0.625")	22.225	28.575	BP0159-0222-0286-BSTH
+0.025/+0.051 (mm)	+0.051/+0.076	+/-0.127	
15.875 (0.625")	22.225	31.750	BP0159-0222-0318-BSHH
+0.051/+0.076 (mm)	+0.051/+0.076	+/-0.127	
15.875 (0.625")	22.225	31.750	BP0159-0222-0318-BSTH
+0.025/+0.051 (mm)	+0.051/+0.076	+/-0.127	
15.875 (0.625")	22.225	34.925	BP0159-0222-0349-BSTH
+0.025/+0.051 (mm)	+0.051/+0.076	+/-0.127	
15.875 (0.625")	22.225	38.100	BP0159-0222-0381-BSHH
+0.051/+0.076 (mm)	+0.051/+0.076	+/-0.127	
15.875 (0.625")	22.225	38.100	BP0159-0222-0381-BSTH
+0.025/+0.051 (mm)	+0.051/+0.076	+/-0.127	
15.875 (0.625")	22.225	38.100	BP0159-0222-0381-BSUH
-0.025/+0.000 (mm)	+0.279/+0.305	+/-0.127	
15.875 (0.625")	22.225	41.275	BP0159-0222-0413-BSTH
+0.025/+0.051 (mm)	+0.051/+0.076	+/-0.190	
15.875 (0.625")	22.225	44.450	BP0159-0222-0445-BSHH
+0.051/+0.076 (mm)	+0.051/+0.076	+/-0.190	
15.875 (0.625")	22.225	50.800	BP0159-0222-0508-BSHH
+0.051/+0.076 (mm)	+0.051/+0.076	+/-0.190	
15.875 (0.625")	22.225	50.800	BP0159-0222-0508-BSTH
+0.025/+0.051 (mm)	+0.051/+0.076	+/-0.190	
15.875 (0.625")	23.813	15.875	BP0159-0238-0159-BSHH1
+0.051/+0.076 (mm)	+0.038/+0.064		
15.875 (0.625")	23.813	15.875	BP0159-0238-0159-BSHH2
+0.051/+0.076 (mm)	+0.063/+0.089	+/-0.127	
15.875 (0.625")	23.813	19.050	BP0159-0238-0191-BSHH1
+0.051/+0.076 (mm)	+0.038/+0.064		
15.875 (0.625")	23.813	19.050	BP0159-0238-0191-BSHH2
+0.051/+0.076 (mm)	+0.063/+0.089	+/-0.127	
15.875 (0.625")	23.813	25.400	BP0159-0238-0254-BSHH1
+0.051/+0.076 (mm)	+0.038/+0.064		
15.875 (0.625")	23.813	25.400	BP0159-0238-0254-BSHH2
+0.051/+0.076 (mm)	+0.063/+0.089	+/-0.127	
15.875 (0.625")	25.400	12.700	BP0159-0254-0127-BSHH
+0.051/+0.076 (mm)	+0.051/+0.076	+/-0.127	
15.875 (0.625")	25.400	15.875	BP0159-0254-0159-BSHH
+0.051/+0.076 (mm)	+0.051/+0.076	+/-0.127	
15.875 (0.625")	25.400	19.050	BP0159-0254-0191-BSHH
+0.051/+0.076 (mm)	+0.064/+0.089	+/-0.127	
15.875 (0.625")	25.400	22.225	BP0159-0254-0222-BSHH
+0.051/+0.076 (mm)	+0.064/+0.089	+/-0.127	
15.875 (0.625")	25.400	25.400	BP0159-0254-0254-BSHH
+0.051/+0.076 (mm)	+0.064/+0.089	+/-0.127	
15.875 (0.625")	25.400	28.575	BP0159-0254-0286-BSHH
+0.051/+0.076 (mm)	+0.063/+0.089	+/-0.127	
15.875 (0.625")	25.400	31.750	BP0159-0254-0318-BSHH
+0.051/+0.076 (mm)	+0.064/+0.089	+/-0.127	
15.875 (0.625")	25.400	34.925	BP0159-0254-0349-BSHH
+0.051/+0.076 (mm)	+0.063/+0.089	+/-0.127	
15.875 (0.625")	25.400	38.100	BP0159-0254-0381-BSHH
+0.051/+0.076 (mm)	+0.064/+0.089	+/-0.127	
15.875 (0.625")	25.400	44.450	BP0159-0254-0445-BSHH
+0.051/+0.076 (mm)	+0.051/+0.076	+/-0.190	
15.875 (0.625")	25.400	50.800	BP0159-0254-0508-BSHH
+0.051/+0.076 (mm)	+0.051/+0.076	+/-0.190	

Stocked or Short Delivery

Usually Available Short Delivery

Long delivery or not in current production

* Large Minimum Quantities

** Available only while stock last:

Bushes - Plain

Nominal ID (d) mm (inches)	Nominal OD (D) mm	Length (S) mm	Part Number
16.000 (0.630") +0.005/+0.030 (mm)	20.000 +0.035/+0.060	12.000 +/-0.127	BP0160-0200-0120-BS
16.000 (0.630") +0.005/+0.030 (mm)	20.000 +0.035/+0.060	16.000 +/-0.120	BP0160-0200-0160-BS
16.000 (0.630") +0.005/+0.030 (mm)	20.000 +0.035/+0.060	16.000 +/-0.127	BP0160-0200-0160-BSLT
16.000 (0.630") +0.005/+0.030 (mm)	20.000 +0.035/+0.060	20.000 +/-0.120	BP0160-0200-0200-BS
16.000 (0.630") +0.005/+0.030 (mm)	20.000 +0.035/+0.060	25.000 +/-0.127	BP0160-0200-0250-BSLT
16.000 (0.630") +0.005/+0.030 (mm)	20.000 +0.035/+0.060	28.000 +/-0.120	BP0160-0200-0280-BS
16.000 (0.630") +0.005/+0.030 (mm)	20.000 +0.035/+0.060	30.000 +/-0.120	BP0160-0200-0300-BS
16.000 (0.630") +0.005/+0.030 (mm)	20.000 +0.035/+0.060	32.000 +/-0.120	BP0160-0200-0320-BS
16.000 (0.630") +0.025/+0.051 (mm)	22.000 +0.035/+0.056	12.000 +/-0.127	BP0160-0220-0120-BS
16.000 (0.630") +0.005/+0.030 (mm)	22.000 +0.035/+0.060	16.000 +/-0.127	BP0160-0220-0160-BS
16.000 (0.630") +0.005/+0.030 (mm)	22.000 +0.035/+0.060	20.000 +/-0.120	BP0160-0220-0200-BS
16.000 (0.630") +0.005/+0.030 (mm)	22.000 +0.035/+0.060	22.000 +/-0.120	BP0160-0220-0220-BS
16.000 (0.630") +0.005/+0.030 (mm)	22.000 +0.035/+0.060	25.000 +/-0.127	BP0160-0220-0250-BSLT
16.000 (0.630") +0.005/+0.030 (mm)	22.000 +0.035/+0.060	30.000 +/-0.127	BP0160-0220-0300-BS
16.000 (0.630") +0.005/+0.030 (mm)	22.000 +0.035/+0.060	32.000 +/-0.120	BP0160-0220-0320-BS
17.463 (0.688") +0.000/+0.025 (mm)	20.638 +0.038/+0.063	25.400 +/-0.127	BP0175-0206-0254-BSLH
17.463 (0.688") +0.000/+0.025 (mm)	20.638 +0.038/+0.063	31.750 +/-0.127	BP0175-0206-0318-BSLH
17.463 (0.688") +0.038/+0.063 (mm)	22.225 +0.051/+0.076	12.700 +/-0.127	BP0175-0222-0127-BSHH
17.463 (0.688") +0.038/+0.063 (mm)	22.225 +0.051/+0.076	19.050 +/-0.127	BP0175-0222-0191-BSHH
17.463 (0.688") -0.013/+0.013 (mm)	22.225 +0.051/+0.076	19.050	BP0175-0222-0191-BSUH
17.463 (0.688") -0.013/+0.013 (mm)	22.225 +0.051/+0.076	25.400	BP0175-0222-0254-BSUH
17.463 (0.688") +0.038/+0.063 (mm)	22.225 +0.051/+0.076	25.400 +/-0.127	BP0175-0222-0254-BSHH
17.463 (0.688") +0.038/+0.063 (mm)	22.225 +0.051/+0.076	28.575 +/-0.127	BP0175-0222-0286-BSHH
17.463 (0.688") +0.038/+0.063 (mm)	22.225 +0.051/+0.076	31.750 +/-0.127	BP0175-0222-0318-BSHH
17.463 (0.688") -0.013/+0.013 (mm)	22.225 +0.051/+0.076	31.750	BP0175-0222-0318-BSUH
17.463 (0.688") +0.038/+0.063 (mm)	22.225 +0.051/+0.076	38.100 +/-0.127	BP0175-0222-0381-BSHH
17.463 (0.688") +0.038/+0.063 (mm)	22.225 +0.051/+0.076	44.450 +/-0.190	BP0175-0222-0445-BSHH
17.463 (0.688") +0.038/+0.063 (mm)	22.225 +0.051/+0.076	50.800 +/-0.190	BP0175-0222-0508-BSHH
17.463 (0.688") +0.012/+0.038 (mm)	23.813 +0.063/+0.089	25.400 +/-0.127	BP0175-0238-0254-BSLH
17.463 (0.688") +0.012/+0.038 (mm)	23.813 +0.063/+0.089	31.750 +/-0.127	BP0175-0238-0318-BSLH
17.463 (0.688") +0.012/+0.038 (mm)	23.813 +0.063/+0.089	38.100 +/-0.127	BP0175-0238-0381-BSLH
18.000 (0.709") +0.005/+0.030 (mm)	22.000 +0.035/+0.060	12.000 +/-0.127	BP0180-0220-0120-BS
18.000 (0.709") +0.005/+0.030 (mm)	22.000 +0.035/+0.060	18.000 +/-0.127	BP0180-0220-0180-BS
18.000 (0.709") +0.005/+0.030 (mm)	22.000 +0.035/+0.060	22.000 +/-0.120	BP0180-0220-0220-BS

Stocked or Short Delivery

Usually Available Short Delivery

Long delivery or not in current production

* Large Minimum Quantities

** Available only while stock last:

Bushes - Plain

Nominal ID (d) mm (inches)	Nominal OD (D) mm	Length (S) mm	Part Number
18.000 (0.709") +0.005/+0.030 (mm)	22.000 +0.035/+0.060	28.000 +/-0.120	BP0180-0220-0280-BS
18.000 (0.709") +0.025/+0.051 (mm)	22.000 +0.035/+0.056	30.000 +/-0.127	BP0180-0220-0300-BS
18.000 (0.709") +0.005/+0.030 (mm)	22.000 +0.035/+0.060	36.000 +/-0.120	BP0180-0220-0360-BS
18.000 (0.709") +0.005/+0.030 (mm)	24.000 +0.035/+0.060	12.000 +/-0.120	BP0180-0240-0120-BS
18.000 (0.709") +0.005/+0.030 (mm)	24.000 +0.035/+0.060	17.000 +/-0.120	BP0180-0240-0170-BS
18.000 (0.709") +0.005/+0.030 (mm)	24.000 +0.035/+0.060	18.000 +/-0.127	BP0180-0240-0180-BS
18.000 (0.709") +0.005/+0.030 (mm)	24.000 +0.035/+0.060	22.000 +/-0.120	BP0180-0240-0220-BS
18.000 (0.709") +0.005/+0.030 (mm)	24.000 +0.035/+0.060	24.000 +/-0.120	BP0180-0240-0240-BS
18.000 (0.709") +0.005/+0.030 (mm)	24.000 +0.035/+0.060	25.000 +/-0.120	BP0180-0240-0250-BS
18.000 (0.709") +0.005/+0.030 (mm)	24.000 +0.035/+0.060	28.000 +/-0.120	BP0180-0240-0280-BS
18.000 (0.709") +0.005/+0.030 (mm)	24.000 +0.035/+0.060	30.000 +/-0.127	BP0180-0240-0300-BS
18.000 (0.709") +0.005/+0.030 (mm)	24.000 +0.035/+0.060	36.000 +/-0.120	BP0180-0240-0360-BS
18.000 (0.709") +0.005/+0.030 (mm)	25.000 +0.035/+0.060	22.000 +/-0.120	BP0180-0250-0220-BS
18.000 (0.709") +0.005/+0.030 (mm)	25.000 +0.035/+0.060	28.000 +/-0.120	BP0180-0250-0280-BS
18.000 (0.709") +0.005/+0.030 (mm)	25.000 +0.035/+0.060	36.000 +/-0.120	BP0180-0250-0360-BS
19.050 (0.750") +0.025/+0.051 (mm)	22.225 +0.076/+0.102	12.700 +/-0.127	BP0191-0222-0127-BSTH
19.050 (0.750") +0.000/+0.025 (mm)	22.225 +0.051/+0.076	14.288 +/-0.127	BP0191-0222-0143-BSLH
19.050 (0.750") +0.000/+0.025 (mm)	22.225 +0.051/+0.076	15.875 +/-0.127	BP0191-0222-0159-BSLH
19.050 (0.750") +0.025/+0.051 (mm)	22.225 +0.076/+0.102	15.875 +/-0.127	BP0191-0222-0159-BSTH
19.050 (0.750") +0.051/+0.076 (mm)	22.225 +0.051/+0.076	15.875 +/-0.127	BP0191-0222-0159-BSHH
19.050 (0.750") +0.051/+0.076 (mm)	22.225 +0.051/+0.076	17.463 +/-0.127	BP0191-0222-0175-BSHH
19.050 (0.750") +0.025/+0.051 (mm)	22.225 +0.076/+0.102	19.050 +/-0.127	BP0191-0222-0191-BSTH
19.050 (0.750") +0.000/+0.025 (mm)	22.225 +0.051/+0.076	19.050 +/-0.127	BP0191-0222-0191-BSLH
19.050 (0.750") +0.051/+0.076 (mm)	22.225 +0.051/+0.076	19.050 +/-0.127	BP0191-0222-0191-BSHH
19.050 (0.750") +0.000/+0.025 (mm)	22.225 +0.051/+0.076	22.225 +/-0.127	BP0191-0222-0223-BSLH
19.050 (0.750") +0.051/+0.076 (mm)	22.225 +0.051/+0.076	22.225 +/-0.127	BP0191-0222-0223-BSHH
19.050 (0.750") +0.025/+0.051 (mm)	22.225 +0.076/+0.102	25.400 +/-0.127	BP0191-0222-0254-BSTH
19.050 (0.750") +0.000/+0.025 (mm)	22.225 +0.051/+0.076	25.400 +/-0.127	BP0191-0222-0254-BSLH
19.050 (0.750") +0.051/+0.076 (mm)	22.225 +0.051/+0.076	25.400 +/-0.127	BP0191-0222-0254-BSHH
19.050 (0.750") +0.051/+0.076 (mm)	22.225 +0.051/+0.076	28.575 +/-0.127	BP0191-0222-0286-BSHH
19.050 (0.750") +0.000/+0.025 (mm)	22.225 +0.051/+0.076	28.575 +/-0.127	BP0191-0222-0286-BSLH
19.050 (0.750") +0.025/+0.051 (mm)	22.225 +0.076/+0.102	31.750 +/-0.127	BP0191-0222-0318-BSTH
19.050 (0.750") +0.051/+0.076 (mm)	22.225 +0.051/+0.076	31.750 +/-0.127	BP0191-0222-0318-BSHH
19.050 (0.750") +0.000/+0.025 (mm)	22.225 +0.051/+0.076	31.750 +/-0.127	BP0191-0222-0318-BSLH

Stocked or Short Delivery

Usually Available Short Delivery

Long delivery or not in current production

* Large Minimum Quantities

** Available only while stock last:

Bushes - Plain

Nominal ID (d) mm (inches)	Nominal OD (D) mm	Length (S) mm	Part Number
19.050 (0.750") +0.000/+0.025 (mm)	22.225 +0.051/+0.076	34.925 +/-0.127	BP0191-0222-0349-BSLH
19.050 (0.750") +0.051/+0.076 (mm)	22.225 +0.051/+0.076	38.100 +/-0.127	BP0191-0222-0381-BSHH
19.050 (0.750") +0.000/+0.025 (mm)	22.225 +0.051/+0.076	38.100 +/-0.127	BP0191-0222-0381-BSLH
19.050 (0.750") +0.051/+0.076 (mm)	22.225 +0.051/+0.076	41.275 +/-0.190	BP0191-0222-0413-BSHH
19.050 (0.750") +0.000/+0.025 (mm)	22.225 +0.051/+0.076	41.275	BP0191-0222-0413-BSLH
19.050 (0.750") +0.051/+0.076 (mm)	23.813 +0.063/+0.089	12.700 +/-0.127	BP0191-0238-0127-BSHH
19.050 (0.750") +0.051/+0.076 (mm)	23.813 +0.063/+0.089	15.875 +/-0.127	BP0191-0238-0159-BSHH
19.050 (0.750") +0.051/+0.076 (mm)	23.813 +0.063/+0.089	19.050 +/-0.127	BP0191-0238-0191-BSHH
19.050 (0.750") +0.025/+0.051 (mm)	23.813 +0.089/+0.114	19.050	BP0191-0238-0191-BSTH
19.050 (0.750") +0.051/+0.076 (mm)	23.813 +0.063/+0.089	22.225 +/-0.127	BP0191-0238-0222-BSHH
19.050 (0.750") +0.025/+0.051 (mm)	23.813 +0.089/+0.114	25.400 +/-0.127	BP0191-0238-0254-BSTH
19.050 (0.750") +0.012/+0.038 (mm)	23.813 +0.038/+0.063	25.400 +/-0.127	BP0191-0238-0254-BSLH
19.050 (0.750") +0.051/+0.076 (mm)	23.813 +0.063/+0.089	25.400 +/-0.127	BP0191-0238-0254-BSHH
19.050 (0.750") +0.051/+0.076 (mm)	23.813 +0.063/+0.089	28.575 +/-0.127	BP0191-0238-0286-BSHH
19.050 (0.750") +0.025/+0.051 (mm)	23.813 +0.089/+0.114	28.575	BP0191-0238-0286-BSTH
19.050 (0.750") +0.012/+0.038 (mm)	23.813 +0.038/+0.063	31.750 +/-0.127	BP0191-0238-0318-BSLH
19.050 (0.750") +0.025/+0.051 (mm)	23.813 +0.089/+0.114	31.750 +/-0.127	BP0191-0238-0318-BSTH
19.050 (0.750") +0.051/+0.076 (mm)	23.813 +0.063/+0.089	31.750 +/-0.127	BP0191-0238-0318-BSHH
19.050 (0.750") +0.025/+0.051 (mm)	23.813 +0.089/+0.114	34.925 +/-0.127	BP0191-0238-0349-BSTH
19.050 (0.750") +0.012/+0.038 (mm)	23.813 +0.038/+0.063	38.100 +/-0.127	BP0191-0238-0381-BSLH
19.050 (0.750") +0.051/+0.076 (mm)	23.813 +0.063/+0.089	38.100 +/-0.127	BP0191-0238-0381-BSHH
19.050 (0.750") +0.025/+0.051 (mm)	23.813 +0.089/+0.114	38.100 +/-0.127	BP0191-0238-0381-BSTH
19.050 (0.750") +0.025/+0.051 (mm)	23.813 +0.089/+0.114	41.275	BP0191-0238-0413-BSTH
19.050 (0.750") +0.051/+0.076 (mm)	23.813 +0.063/+0.089	41.275 +/-0.190	BP0191-0238-0413-BSHH
19.050 (0.750") +0.012/+0.038 (mm)	23.813 +0.038/+0.063	44.450 +/-0.190	BP0191-0238-0445-BSLH
19.050 (0.750") +0.025/+0.051 (mm)	23.813 +0.089/+0.114	44.450 +/-0.190	BP0191-0238-0445-BSTH
19.050 (0.750") +0.051/+0.076 (mm)	23.813 +0.063/+0.089	44.450 +/-0.190	BP0191-0238-0445-BSHH
19.050 (0.750") +0.051/+0.076 (mm)	23.813 +0.063/+0.089	47.625 +/-0.190	BP0191-0238-0476-BSHH
19.050 (0.750") +0.051/+0.076 (mm)	23.813 +0.063/+0.089	50.800 +/-0.190	BP0191-0238-0508-BSHH
19.050 (0.750") +0.025/+0.051 (mm)	23.813 +0.089/+0.114	50.800	BP0191-0238-0508-BSTH
19.050 (0.750") +0.025/+0.051 (mm)	25.400 +0.038/+0.063	9.525 +/-0.127	BP0191-0254-0095-BSTH
19.050 (0.750") +0.025/+0.051 (mm)	25.400 +0.038/+0.064	12.700	BP0191-0254-0127-BSTH1
19.050 (0.750") +0.025/+0.051 (mm)	25.400 +0.076/+0.102	12.700 +/-0.127	BP0191-0254-0127-BSTH2
19.050 (0.750") +0.025/+0.051 (mm)	25.400 +0.076/+0.102	15.875 +/-0.127	BP0191-0254-0159-BSTH

 Stocked or Short Delivery

 Usually Available Short Delivery

 Long delivery or not in current production

* Large Minimum Quantities

** Available only while stock last:

Bushes - Plain

Nominal ID (d) mm (inches)	Nominal OD (D) mm	Length (S) mm	Part Number
19.050 (0.750") -0.013/+0.013 (mm)	25.400 +0.038/+0.063	19.050 +/-0.127	BP0191-0254-0191-BSUH
19.050 (0.750") +0.025/+0.051 (mm)	25.400 +0.076/+0.102	19.050 +/-0.127	BP0191-0254-0191-BSTH2
19.050 (0.750") +0.025/+0.051 (mm)	25.400 +0.038/+0.063	19.050 +/-0.127	BP0191-0254-0191-BSTH1
19.050 (0.750") +0.051/+0.076 (mm)	25.400 +0.051/+0.076	19.050 +/-0.127	BP0191-0254-0191-BSHH
19.050 (0.750") +0.025/+0.051 (mm)	25.400 +0.038/+0.063	22.225 +/-0.127	BP0191-0254-0222-BSTH
19.050 (0.750") +0.051/+0.076 (mm)	25.400 +0.051/+0.076	22.225 +/-0.127	BP0191-0254-0222-BSHH
19.050 (0.750") +0.051/+0.076 (mm)	25.400 +0.051/+0.076	25.400 +/-0.127	BP0191-0254-0254-BSHH
19.050 (0.750") +0.025/+0.051 (mm)	25.400 +0.038/+0.063	25.400 +/-0.127	BP0191-0254-0254-BSTH1
19.050 (0.750") -0.013/+0.013 (mm)	25.400 +0.038/+0.063	25.400 +/-0.127	BP0191-0254-0254-BSUH
19.050 (0.750") +0.025/+0.051 (mm)	25.400 +0.076/+0.102	25.400 +/-0.127	BP0191-0254-0254-BSTH2
19.050 (0.750") -0.013/+0.013 (mm)	25.400 +0.038/+0.063	28.575 +/-0.127	BP0191-0254-0286-BSUH
19.050 (0.750") +0.051/+0.076 (mm)	25.400 +0.051/+0.076	28.575 +/-0.127	BP0191-0254-0286-BSHH
19.050 (0.750") +0.025/+0.051 (mm)	25.400 +0.038/+0.063	28.575 +/-0.127	BP0191-0254-0286-BSTH
19.050 (0.750") -0.013/+0.013 (mm)	25.400 +0.038/+0.063	31.750 +/-0.127	BP0191-0254-0318-BSUH
19.050 (0.750") +0.025/+0.051 (mm)	25.400 +0.076/+0.102	31.750 +/-0.127	BP0191-0254-0318-BSTH2
19.050 (0.750") +0.025/+0.051 (mm)	25.400 +0.038/+0.063	31.750 +/-0.127	BP0191-0254-0318-BSTH1
19.050 (0.750") +0.051/+0.076 (mm)	25.400 +0.051/+0.076	31.750 +/-0.127	BP0191-0254-0318-BSHH
19.050 (0.750") +0.025/+0.051 (mm)	25.400 +0.038/+0.063	34.925 +/-0.127	BP0191-0254-0349-BSTH
19.050 (0.750") +0.025/+0.051 (mm)	25.400 +0.076/+0.102	38.100 +/-0.127	BP0191-0254-0381-BSTH2
19.050 (0.750") +0.025/+0.051 (mm)	25.400 +0.038/+0.063	38.100 +/-0.127	BP0191-0254-0381-BSTH1
19.050 (0.750") +0.051/+0.076 (mm)	25.400 +0.051/+0.076	38.100 +/-0.127	BP0191-0254-0381-BSHH
19.050 (0.750") -0.013/+0.013 (mm)	25.400 +0.038/+0.063	38.100 +/-0.127	BP0191-0254-0381-BSUH
19.050 (0.750") +0.025/+0.051 (mm)	25.400 +0.076/+0.102	44.450 +/-0.190	BP0191-0254-0445-BSTH2
19.050 (0.750") +0.025/+0.051 (mm)	25.400 +0.038/+0.064	44.450	BP0191-0254-0445-BSTH1
19.050 (0.750") +0.025/+0.051 (mm)	25.400 +0.025/+0.203	47.625 +/-0.397	BP0191-0254-0476-BSTH
19.050 (0.750") +0.051/+0.076 (mm)	25.400 +0.051/+0.076	50.800 +/-0.190	BP0191-0254-0508-BSHH
19.050 (0.750") +0.025/+0.051 (mm)	25.400 +0.038/+0.064	50.800	BP0191-0254-0508-BSTH
19.050 (0.750") +0.025/+0.051 (mm)	25.400 +0.038/+0.063	53.975 +/-0.190	BP0191-0254-0540-BSTH
19.050 (0.750") +0.025/+0.051 (mm)	25.400 +0.038/+0.063	57.150 +/-0.190	BP0191-0254-0572-BSTH
19.050 (0.750") +0.025/+0.051 (mm)	25.400 +0.038/+0.064	63.500	BP0191-0254-0635-BSTH1
19.050 (0.750") +0.025/+0.051 (mm)	25.400 +0.076/+0.102	63.500 +/-0.190	BP0191-0254-0635-BSTH2
19.050 (0.750") +0.000/+0.025 (mm)	26.988 +0.025/+0.051	25.400 +/-0.127	BP0191-0270-0254-BSLT
19.050 (0.750") +0.000/+0.025 (mm)	26.988 +0.025/+0.051	31.750 +/-0.127	BP0191-0270-0318-BSLT
19.050 (0.750") +0.051/+0.076 (mm)	28.575 +0.051/+0.076	12.700 +/-0.127	BP0191-0286-0127-BSHH

Stocked or Short Delivery

Usually Available Short Delivery

Long delivery or not in current production

* Large Minimum Quantities

** Available only while stock last:

Bushes - Plain

Nominal ID (d) mm (inches)	Nominal OD (D) mm	Length (S) mm	Part Number
19.050 (0.750")	28.575	19.050	BP0191-0286-0191-BSHH
+0.051/+0.076 (mm)	+0.051/+0.076	+/-0.127	
19.050 (0.750")	28.575	19.050	BP0191-0286-0191-BSUH
-0.025/+0.000 (mm)	+0.076/+0.102	+/-0.127	
19.050 (0.750")	28.575	25.400	BP0191-0286-0254-BSTH
+0.025/+0.051 (mm)	+0.076/+0.102	+/-0.127	
19.050 (0.750")	28.575	31.750	BP0191-0286-0318-BSHH
+0.051/+0.076 (mm)	+0.051/+0.076	+/-0.127	
19.050 (0.750")	28.575	31.750	BP0191-0286-0318-BSUH
-0.025/+0.000 (mm)	+0.076/+0.102	+/-0.127	
19.050 (0.750")	28.575	34.925	BP0191-0286-0349-BSHH
+0.051/+0.076 (mm)	+0.051/+0.076	+/-0.127	
19.050 (0.750")	28.575	38.100	BP0191-0286-0381-BSHH
+0.051/+0.076 (mm)	+0.051/+0.076	+/-0.127	
19.050 (0.750")	28.575	44.450	BP0191-0286-0445-BSHH
+0.051/+0.076 (mm)	+0.051/+0.076	+/-0.190	
19.050 (0.750")	28.575	50.800	BP0191-0286-0508-BSHH
+0.051/+0.076 (mm)	+0.051/+0.076	+/-0.190	
19.050 (0.750")	31.750	19.050	BP0191-0318-0191-BSHH
+0.051/+0.076 (mm)	+0.051/+0.076	+/-0.127	
19.050 (0.750")	31.750	25.400	BP0191-0318-0254-BSHH
+0.051/+0.076 (mm)	+0.051/+0.076	+/-0.127	
19.050 (0.750")	31.750	31.750	BP0191-0318-0318-BSHH
+0.051/+0.076 (mm)	+0.051/+0.076	+/-0.127	
19.050 (0.750")	31.750	38.100	BP0191-0318-0381-BSHH
+0.051/+0.076 (mm)	+0.051/+0.076	+/-0.127	
20.000 (0.787")	23.000	24.000	BP0200-0230-0240-BS
+0.005/+0.030 (mm)	+0.035/+0.060	+/-0.120	
20.000 (0.787")	24.000	15.000	BP0200-0240-0150-BS
+0.025/+0.051 (mm)	+0.035/+0.056	+/-0.127	
20.000 (0.787")	24.000	16.000	BP0200-0240-0160-BS
+0.005/+0.030 (mm)	+0.035/+0.060	+/-0.120	
20.000 (0.787")	24.000	20.000	BP0200-0240-0200-BS
+0.005/+0.030 (mm)	+0.035/+0.060	+/-0.127	
20.000 (0.787")	24.000	24.000	BP0200-0240-0240-BS
+0.005/+0.030 (mm)	+0.035/+0.060	+/-0.120	
20.000 (0.787")	24.000	25.000	BP0200-0240-0250-BSLT
+0.005/+0.030 (mm)	+0.035/+0.060	+/-0.127	
20.000 (0.787")	24.000	27.000	BP0200-0240-0270-BS
+0.005/+0.030 (mm)	+0.035/+0.060	+/-0.120	
20.000 (0.787")	24.000	30.000	BP0200-0240-0300-BS
+0.005/+0.030 (mm)	+0.035/+0.060	+/-0.120	
20.000 (0.787")	24.000	32.000	BP0200-0240-0320-BS
+0.005/+0.030 (mm)	+0.035/+0.060	+/-0.120	
20.000 (0.787")	25.000	15.000	BP0200-0250-0150-BS
+0.005/+0.030 (mm)	+0.035/+0.060	+/-0.120	
20.000 (0.787")	25.000	16.000	BP0200-0250-0160-BS
+0.005/+0.030 (mm)	+0.035/+0.060	+/-0.120	
20.000 (0.787")	25.000	20.000	BP0200-0250-0200-BS
+0.005/+0.030 (mm)	+0.035/+0.060	+/-0.120	
20.000 (0.787")	25.000	22.000	BP0200-0250-0220-BS
+0.005/+0.030 (mm)	+0.035/+0.060	+/-0.120	
20.000 (0.787")	25.000	25.000	BP0200-0250-0250-BS
+0.005/+0.030 (mm)	+0.035/+0.060	+/-0.120	
20.000 (0.787")	25.000	28.000	BP0200-0250-0280-BS
+0.005/+0.030 (mm)	+0.035/+0.060	+/-0.120	
20.000 (0.787")	25.000	30.000	BP0200-0250-0300-BS
+0.005/+0.030 (mm)	+0.035/+0.060	+/-0.120	
20.000 (0.787")	25.000	32.000	BP0200-0250-0320-BS
+0.005/+0.030 (mm)	+0.035/+0.060	+/-0.120	
20.000 (0.787")	26.000	15.000	BP0200-0260-0150-BS
+0.005/+0.030 (mm)	+0.035/+0.060	+/-0.127	
20.000 (0.787")	26.000	16.000	BP0200-0260-0160-BS
+0.005/+0.030 (mm)	+0.035/+0.060	+/-0.120	
20.000 (0.787")	26.000	20.000	BP0200-0260-0200-BS
+0.005/+0.030 (mm)	+0.035/+0.060	+/-0.127	
20.000 (0.787")	26.000	25.000	BP0200-0260-0250-BSLT
+0.005/+0.030 (mm)	+0.035/+0.060	+/-0.127	

Stocked or Short Delivery

Usually Available Short Delivery

Long delivery or not in current production

* Large Minimum Quantities

** Available only while stock last:

Bushes - Plain

Nominal ID (d) mm (inches)	Nominal OD (D) mm	Length (S) mm	Part Number
20.000 (0.787") +0.005/+0.030 (mm)	26.000 +0.035/+0.060	32.000 +/-0.120	BP0200-0260-0320-BS
20.000 (0.787") +0.005/+0.030 (mm)	27.000 +0.035/+0.060	16.000 +/-0.120	BP0200-0270-0160-BS
20.000 (0.787") +0.005/+0.030 (mm)	27.000 +0.035/+0.060	20.000 +/-0.120	BP0200-0270-0200-BS
20.000 (0.787") +0.005/+0.030 (mm)	27.000 +0.035/+0.060	25.000 +/-0.120	BP0200-0270-0250-BS
20.000 (0.787") +0.005/+0.030 (mm)	27.000 +0.035/+0.060	32.000 +/-0.120	BP0200-0270-0320-BS
20.000 (0.787") +0.005/+0.030 (mm)	28.000 +0.035/+0.060	16.000 +/-0.120	BP0200-0280-0160-BS
20.000 (0.787") +0.005/+0.030 (mm)	28.000 +0.035/+0.060	20.000 +/-0.120	BP0200-0280-0200-BS
20.000 (0.787") +0.005/+0.030 (mm)	28.000 +0.035/+0.060	25.000 +/-0.120	BP0200-0280-0250-BS
20.000 (0.787") +0.005/+0.030 (mm)	28.000 +0.035/+0.060	28.000 +/-0.120	BP0200-0280-0280-BS
20.000 (0.787") +0.005/+0.030 (mm)	28.000 +0.035/+0.060	30.000 +/-0.120	BP0200-0280-0300-BS
20.000 (0.787") +0.005/+0.030 (mm)	28.000 +0.035/+0.060	32.000 +/-0.120	BP0200-0280-0320-BS
20.000 (0.787") +0.005/+0.030 (mm)	30.000 +0.035/+0.060	25.000 +/-0.127	BP0200-0300-0250-BSLT
20.638 (0.813") +0.038/+0.063 (mm)	25.400 +0.051/+0.076	19.050 +/-0.127	BP0206-0254-0191-BSHH
20.638 (0.813") +0.038/+0.063 (mm)	25.400 +0.051/+0.076	25.400 +/-0.127	BP0206-0254-0254-BSHH
20.638 (0.813") +0.000/+0.025 (mm)	25.400 +0.051/+0.076	25.400 +/-0.127	BP0206-0254-0254-BSLH
20.638 (0.813") +0.025/+0.051 (mm)	25.400 +0.051/+0.076	25.400 +/-0.127	BP0206-0254-0254-BSTH
20.638 (0.813") +0.025/+0.051 (mm)	25.400 +0.051/+0.076	31.750 +/-0.127	BP0206-0254-0318-BSTH
20.638 (0.813") +0.038/+0.063 (mm)	25.400 +0.051/+0.076	31.750 +/-0.127	BP0206-0254-0318-BSHH
20.638 (0.813") +0.000/+0.025 (mm)	25.400 +0.051/+0.076	31.750 +/-0.127	BP0206-0254-0318-BSLH
20.638 (0.813") +0.038/+0.063 (mm)	25.400 +0.051/+0.076	38.100 +/-0.127	BP0206-0254-0381-BSHH
20.638 (0.813") +0.038/+0.063 (mm)	25.400 +0.051/+0.076	44.450 +/-0.190	BP0206-0254-0445-BSHH
20.638 (0.813") +0.000/+0.025 (mm)	25.400 +0.051/+0.076	44.450 +/-0.190	BP0206-0254-0445-BSLH
20.638 (0.813") +0.038/+0.063 (mm)	25.400 +0.051/+0.076	50.800 +/-0.190	BP0206-0254-0508-BSHH
20.638 (0.813") +0.038/+0.063 (mm)	26.988 +0.038/+0.063	25.400 +/-0.127	BP0206-0270-0254-BSHH
20.638 (0.813") +0.038/+0.063 (mm)	26.988 +0.038/+0.063	31.750 +/-0.127	BP0206-0270-0318-BSHH
20.663 (0.814") +0.025/+0.051 (mm)	25.400 +0.051/+0.076	22.225 +/-0.127	BP0207-0254-0222-BSTH
22.000 (0.866") +0.005/+0.030 (mm)	27.000 +0.035/+0.060	15.000 +/-0.120	BP0220-0270-0150-BS
22.000 (0.866") +0.005/+0.030 (mm)	27.000 +0.035/+0.060	18.000 +/-0.120	BP0220-0270-0180-BS
22.000 (0.866") +0.005/+0.030 (mm)	27.000 +0.035/+0.060	20.000 +/-0.120	BP0220-0270-0200-BS
22.000 (0.866") +0.005/+0.030 (mm)	27.000 +0.035/+0.060	22.000 +/-0.120	BP0220-0270-0220-BS
22.000 (0.866") +0.005/+0.030 (mm)	27.000 +0.035/+0.060	25.000 +/-0.120	BP0220-0270-0250-BS
22.000 (0.866") +0.005/+0.030 (mm)	27.000 +0.035/+0.060	28.000 +/-0.120	BP0220-0270-0280-BS
22.000 (0.866") +0.005/+0.030 (mm)	27.000 +0.035/+0.060	36.000 +/-0.120	BP0220-0270-0360-BS
22.000 (0.866") +0.025/+0.051 (mm)	28.000 +0.035/+0.056	15.000 +/-0.127	BP0220-0280-0150-BS

 Stocked or Short Delivery

 Usually Available Short Delivery

 Long delivery or not in current production

* Large Minimum Quantities

** Available only while stock last:

Bushes - Plain

Nominal ID (d) mm (inches)	Nominal OD (D) mm	Length (S) mm	Part Number
22.000 (0.866") +0.005/+0.030 (mm)	28.000 +0.035/+0.060	18.000 +/-0.120	BP0220-0280-0180-BS
22.000 (0.866") +0.005/+0.030 (mm)	28.000 +0.035/+0.060	20.000 +/-0.127	BP0220-0280-0200-BS
22.000 (0.866") +0.005/+0.030 (mm)	28.000 +0.035/+0.060	22.000 +/-0.120	BP0220-0280-0220-BS
22.000 (0.866") +0.025/+0.051 (mm)	28.000 +0.035/+0.056	25.000 +/-0.127	BP0220-0280-0250-BS
22.000 (0.866") +0.005/+0.030 (mm)	28.000 +0.035/+0.060	28.000 +/-0.120	BP0220-0280-0280-BS
22.000 (0.866") +0.005/+0.030 (mm)	28.000 +0.035/+0.060	30.000 +/-0.127	BP0220-0280-0300-BS
22.000 (0.866") +0.005/+0.030 (mm)	28.000 +0.035/+0.060	36.000 +/-0.120	BP0220-0280-0360-BS
22.000 (0.866") +0.005/+0.030 (mm)	29.000 +0.035/+0.060	18.000 +/-0.120	BP0220-0290-0180-BS
22.000 (0.866") +0.005/+0.030 (mm)	29.000 +0.035/+0.060	22.000 +/-0.120	BP0220-0290-0220-BS
22.000 (0.866") +0.005/+0.030 (mm)	29.000 +0.035/+0.060	28.000 +/-0.120	BP0220-0290-0280-BS
22.000 (0.866") +0.005/+0.030 (mm)	29.000 +0.035/+0.060	36.000 +/-0.120	BP0220-0290-0360-BS
22.000 (0.866") +0.025/+0.051 (mm)	32.000 +0.043/+0.068	20.000 +/-0.127	* BP0220-0320-0200-BSTH
22.000 (0.866") +0.025/+0.051 (mm)	32.000 +0.043/+0.068	50.000 +/-0.190	BP0220-0320-0500-BSTH
22.225 (0.875") +0.000/+0.025 (mm)	25.400 +0.051/+0.076	9.525 +/-0.127	BP0222-0254-0095-BSLH
22.225 (0.875") +0.000/+0.025 (mm)	25.400 +0.051/+0.076	11.113 +/-0.127	BP0222-0254-0111-BSLH
22.225 (0.875") +0.000/+0.025 (mm)	25.400 +0.051/+0.076	12.700 +/-0.127	BP0222-0254-0127-BSLH
22.225 (0.875") +0.025/+0.051 (mm)	25.400 +0.051/+0.076	15.875 +/-0.127	BP0222-0254-0159-BSTH
22.225 (0.875") +0.000/+0.025 (mm)	25.400 +0.051/+0.076	15.875 +/-0.127	BP0222-0254-0159-BSLH
22.225 (0.875") +0.000/+0.025 (mm)	25.400 +0.051/+0.076	19.050 +/-0.127	BP0222-0254-0191-BSLH
22.225 (0.875") +0.051/+0.076 (mm)	25.400 +0.051/+0.076	19.050 +/-0.127	BP0222-0254-0191-BSHH
22.225 (0.875") +0.025/+0.051 (mm)	25.400 +0.051/+0.076	19.050 +/-0.127	BP0222-0254-0191-BSTH
22.225 (0.875") +0.051/+0.076 (mm)	25.400 +0.051/+0.076	22.225 +/-0.127	BP0222-0254-0223-BSHH
22.225 (0.875") +0.000/+0.025 (mm)	25.400 +0.051/+0.076	25.400 +/-0.127	BP0222-0254-0254-BSLH
22.225 (0.875") +0.025/+0.051 (mm)	25.400 +0.076/+0.102	25.400 +/-0.127	BP0222-0254-0254-BSTH
22.225 (0.875") +0.025/+0.051 (mm)	25.400 +0.051/+0.076	28.575 +/-0.127	BP0222-0254-0286-BSTH
22.225 (0.875") +0.025/+0.051 (mm)	25.400 +0.051/+0.076	31.750 +/-0.127	BP0222-0254-0318-BSTH
22.225 (0.875") +0.000/+0.025 (mm)	25.400 +0.051/+0.076	31.750 +/-0.127	BP0222-0254-0318-BSLH
22.225 (0.875") +0.051/+0.076 (mm)	25.400 +0.051/+0.076	31.750 +/-0.127	BP0222-0254-0318-BSHH
22.225 (0.875") +0.000/+0.025 (mm)	25.400 +0.051/+0.076	38.100 +/-0.127	BP0222-0254-0381-BSLH
22.225 (0.875") +0.051/+0.076 (mm)	25.400 +0.051/+0.076	44.450 +/-0.190	BP0222-0254-0445-BSHH
22.225 (0.875") +0.000/+0.025 (mm)	25.400 +0.051/+0.076	44.450 +/-0.127	BP0222-0254-0445-BSLH
22.225 (0.875") +0.025/+0.051 (mm)	26.988 +0.038/+0.063	19.050 +/-0.127	BP0222-0270-0191-BSTH
22.225 (0.875") +0.051/+0.076 (mm)	26.988 +0.051/+0.076	25.400 +/-0.127	BP0222-0270-0254-BSHH
22.225 (0.875") +0.025/+0.051 (mm)	26.988 +0.038/+0.064	31.750 +/-0.127	BP0222-0270-0318-BSTH

 Stocked or Short Delivery

 Usually Available Short Delivery

 Long delivery or not in current production

* Large Minimum Quantities

** Available only while stock last:

Bushes - Plain

Nominal ID (d) mm (inches)	Nominal OD (D) mm	Length (S) mm	Part Number
22.225 (0.875") +0.051/+0.076 (mm)	26.988 +0.051/+0.076	31.750 +/-0.127	BP0222-0270-0318-BSHH
22.225 (0.875") +0.025/+0.051 (mm)	28.575 +0.076/+0.102	19.050 +/-0.127	BP0222-0286-0191-BSTH
22.225 (0.875") +0.000/+0.025 (mm)	28.575 +0.051/+0.076	19.050	BP0222-0286-0191-BSLH
22.225 (0.875") +0.000/+0.025 (mm)	28.575 +0.051/+0.076	22.225	BP0222-0286-0223-BSLH
22.225 (0.875") +0.051/+0.076 (mm)	28.575 +0.051/+0.076	22.225 +/-0.127	BP0222-0286-0223-BSHH
22.225 (0.875") +0.051/+0.076 (mm)	28.575 +0.038/+0.063	25.400 +/-0.127	BP0222-0286-0254-BSHH
22.225 (0.875") +0.025/+0.051 (mm)	28.575 +0.076/+0.102	25.400 +/-0.127	BP0222-0286-0254-BSTH
22.225 (0.875") +0.000/+0.025 (mm)	28.575 +0.051/+0.076	25.400 +/-0.127	BP0222-0286-0254-BSLH
22.225 (0.875") +0.000/+0.025 (mm)	28.575 +0.051/+0.076	28.575	BP0222-0286-0286-BSLH
22.225 (0.875") +0.051/+0.076 (mm)	28.575 +0.051/+0.076	28.575 +/-0.127	BP0222-0286-0286-BSHH
22.225 (0.875") +0.025/+0.051 (mm)	28.575 +0.076/+0.102	31.750 +/-0.127	BP0222-0286-0318-BSTH
22.225 (0.875") +0.000/+0.025 (mm)	28.575 +0.051/+0.076	31.750 +/-0.127	BP0222-0286-0318-BSLH
22.225 (0.875") +0.051/+0.076 (mm)	28.575 +0.038/+0.063	31.750 +/-0.127	BP0222-0286-0318-BSHH
22.225 (0.875") +0.051/+0.076 (mm)	28.575 +0.038/+0.064	34.925 +/-0.127	BP0222-0286-0349-BSHH
22.225 (0.875") +0.000/+0.025 (mm)	28.575 +0.051/+0.076	34.925 +/-0.127	BP0222-0286-0349-BSLH
22.225 (0.875") +0.051/+0.076 (mm)	28.575 +0.038/+0.064	38.100 +/-0.127	BP0222-0286-0381-BSHH
22.225 (0.875") +0.000/+0.025 (mm)	28.575 +0.051/+0.076	38.100 +/-0.127	BP0222-0286-0381-BSLH
22.225 (0.875") +0.051/+0.076 (mm)	28.575 +0.051/+0.076	41.275 +/-0.190	BP0222-0286-0413-BSHH
22.225 (0.875") +0.000/+0.025 (mm)	28.575 +0.051/+0.076	44.450	BP0222-0286-0445-BSLH
22.225 (0.875") +0.051/+0.076 (mm)	28.575 +0.051/+0.076	44.450 +/-0.190	BP0222-0286-0445-BSHH
22.225 (0.875") +0.051/+0.076 (mm)	28.575 +0.051/+0.076	50.800 +/-0.190	BP0222-0286-0508-BSHH
22.225 (0.875") +0.000/+0.025 (mm)	28.575 +0.051/+0.076	50.800	BP0222-0286-0508-BSLH
22.225 (0.875") +0.000/+0.025 (mm)	28.575 +0.051/+0.076	57.150	BP0222-0286-0572-BSLH
22.225 (0.875") +0.051/+0.076 (mm)	28.575 +0.051/+0.076	57.150 +/-0.190	BP0222-0286-0572-BSHH
22.225 (0.875") +0.051/+0.076 (mm)	28.575 +0.051/+0.076	63.500 +/-0.190	BP0222-0286-0635-BSHH
22.225 (0.875") +0.000/+0.025 (mm)	28.575 +0.051/+0.076	63.500	BP0222-0286-0635-BSLH
22.225 (0.875") +0.000/+0.025 (mm)	28.575 +0.051/+0.076	69.850 +/-0.190	BP0222-0286-0699-BSLH
22.225 (0.875") +0.051/+0.076 (mm)	31.750 +0.051/+0.076	19.050 +/-0.127	BP0222-0318-0191-BSHH
22.225 (0.875") +0.051/+0.076 (mm)	31.750 +0.051/+0.076	25.400 +/-0.127	BP0222-0318-0254-BSHH
22.225 (0.875") +0.025/+0.051 (mm)	31.750 +0.025/+0.051	25.400	BP0222-0318-0254-BS
22.225 (0.875") +0.025/+0.051 (mm)	31.750 +0.025/+0.051	31.750	BP0222-0318-0318-BS
22.225 (0.875") +0.051/+0.076 (mm)	31.750 +0.051/+0.076	31.750 +/-0.127	BP0222-0318-0318-BSHH
22.225 (0.875") +0.051/+0.076 (mm)	31.750 +0.051/+0.076	34.925 +/-0.127	BP0222-0318-0349-BSHH
22.225 (0.875") +0.051/+0.076 (mm)	31.750 +0.051/+0.076	38.100 +/-0.127	BP0222-0318-0381-BSHH

 Stocked or Short Delivery

 Usually Available Short Delivery

 Long delivery or not in current production

* Large Minimum Quantities

** Available only while stock last:

Bushes - Plain

Nominal ID (d) mm (inches)	Nominal OD (D) mm	Length (S) mm	Part Number
22.225 (0.875") +0.025/+0.051 (mm)	31.750 +0.025/+0.051	38.100	BP0222-0318-0381-BS
22.225 (0.875") +0.051/+0.076 (mm)	31.750 +0.051/+0.076	50.800 +/-0.190	BP0222-0318-0508-BSHH
23.813 (0.938") +0.038/+0.063 (mm)	26.988 +0.038/+0.063	19.050 +/-0.127	BP0238-0270-0191-BSHH
23.813 (0.938") +0.038/+0.063 (mm)	26.988 +0.038/+0.063	31.750 +/-0.127	BP0238-0270-0318-BSHH
23.813 (0.938") +0.038/+0.063 (mm)	30.163 +0.038/+0.063	19.050 +/-0.127	BP0238-0302-0191-BSHH
23.813 (0.938") +0.012/+0.038 (mm)	30.163 +0.025/+0.051	22.225 +/-0.127	BP0238-0302-0222-BSLT
23.813 (0.938") +0.012/+0.038 (mm)	30.163 +0.025/+0.051	25.400 +/-0.127	BP0238-0302-0254-BSLT
23.813 (0.938") +0.038/+0.063 (mm)	30.163 +0.038/+0.063	25.400 +/-0.127	BP0238-0302-0254-BSHH
23.813 (0.938") +0.038/+0.063 (mm)	30.163 +0.038/+0.063	31.750 +/-0.127	BP0238-0302-0318-BSHH
23.813 (0.938") +0.012/+0.038 (mm)	30.163 +0.025/+0.051	31.750 +/-0.127	BP0238-0302-0318-BSLT
23.813 (0.938") +0.012/+0.038 (mm)	30.163 +0.025/+0.051	38.100 +/-0.127	BP0238-0302-0381-BSLT
23.813 (0.938") +0.038/+0.063 (mm)	30.163 +0.038/+0.063	38.100 +/-0.127	BP0238-0302-0381-BSHH
23.813 (0.938") +0.038/+0.063 (mm)	30.163 +0.038/+0.063	50.800 +/-0.190	BP0238-0302-0508-BSHH
23.813 (0.938") +0.038/+0.064 (mm)	31.750 +0.076/+0.102	19.050 +/-0.127	BP0238-0318-0191-BSHH
23.813 (0.938") +0.038/+0.064 (mm)	31.750 +0.076/+0.102	25.400 +/-0.127	BP0238-0318-0254-BSHH
23.813 (0.938") -0.025/+0.000 (mm)	31.750 +0.051/+0.076	25.400 +/-0.127	BP0238-0318-0254-BSUH
23.813 (0.938") -0.025/+0.000 (mm)	31.750 +0.051/+0.076	31.750 +/-0.127	BP0238-0318-0318-BSUH
23.813 (0.938") +0.038/+0.064 (mm)	31.750 +0.076/+0.102	31.750 +/-0.127	BP0238-0318-0318-BSHH
23.813 (0.938") -0.025/+0.000 (mm)	31.750 +0.051/+0.076	38.100 +/-0.127	BP0238-0318-0381-BSUH
23.813 (0.938") +0.038/+0.064 (mm)	31.750 +0.076/+0.102	38.100 +/-0.127	BP0238-0318-0381-BSHH
23.813 (0.938") +0.038/+0.064 (mm)	31.750 +0.076/+0.102	44.450 +/-0.190	BP0238-0318-0445-BSHH
23.813 (0.938") +0.038/+0.064 (mm)	31.750 +0.076/+0.102	50.800 +/-0.190	BP0238-0318-0508-BSHH
25.000 (0.984") +0.025/+0.051 (mm)	30.000 +0.035/+0.056	20.000 +/-0.127	BP0250-0300-0200-BS
25.000 (0.984") +0.005/+0.030 (mm)	30.000 +0.035/+0.060	25.000 +/-0.127	BP0250-0300-0250-BS
25.000 (0.984") +0.005/+0.030 (mm)	30.000 +0.035/+0.060	28.000 +/-0.120	BP0250-0300-0280-BS
25.000 (0.984") +0.005/+0.030 (mm)	30.000 +0.035/+0.060	30.000 +/-0.160	BP0250-0300-0300-BSLT
25.000 (0.984") +0.005/+0.030 (mm)	30.000 +0.035/+0.060	32.000 +/-0.120	BP0250-0300-0320-BS
25.000 (0.984") +0.005/+0.030 (mm)	30.000 +0.035/+0.060	35.000 +/-0.120	BP0250-0300-0350-BS
25.000 (0.984") +0.005/+0.030 (mm)	30.000 +0.035/+0.060	40.000 +/-0.190	BP0250-0300-0400-BS
25.000 (0.984") +0.005/+0.030 (mm)	30.000 +0.035/+0.060	45.000 +/-0.190	BP0250-0300-0450-BS
25.000 (0.984") +0.005/+0.030 (mm)	30.000 +0.035/+0.060	50.000 +/-0.190	BP0250-0300-0500-BSLT
25.000 (0.984") +0.005/+0.030 (mm)	32.000 +0.040/+0.070	20.000 +/-0.120	BP0250-0320-0200-BS
25.000 (0.984") +0.005/+0.030 (mm)	32.000 +0.040/+0.070	25.000 +/-0.127	BP0250-0320-0250-BSLT
25.000 (0.984") +0.005/+0.030 (mm)	32.000 +0.040/+0.070	30.000 +/-0.120	BP0250-0320-0300-BS

 Stocked or Short Delivery

 Usually Available Short Delivery

 Long delivery or not in current production

* Large Minimum Quantities

** Available only while stock last:

Bushes - Plain

Nominal ID (d) mm (inches)	Nominal OD (D) mm	Length (S) mm	Part Number
25.000 (0.984") +0.005/+0.030 (mm)	32.000 +0.040/+0.070	32.000 +/-0.120	BP0250-0320-0320-BS
25.000 (0.984") +0.005/+0.030 (mm)	32.000 +0.040/+0.070	35.000 +/-0.120	BP0250-0320-0350-BS
25.000 (0.984") +0.005/+0.030 (mm)	32.000 +0.040/+0.070	40.000 +/-0.190	BP0250-0320-0400-BS
25.000 (0.984") +0.005/+0.030 (mm)	35.000 +0.040/+0.070	25.000 +/-0.127	BP0250-0350-0250-BSTH
25.000 (0.984") +0.005/+0.030 (mm)	35.000 +0.040/+0.070	35.000 +/-0.127	BP0250-0350-0350-BSLT
25.000 (0.984") +0.025/+0.051 (mm)	35.000 +0.043/+0.068	50.000 +/-0.190	BP0250-0350-0500-BSTH
25.400 (1.000") +0.000/+0.025 (mm)	28.575 +0.051/+0.076	12.700 +/-0.127	BP0254-0286-0127-BSLH
25.400 (1.000") +0.063/+0.088 (mm)	28.575 +0.051/+0.076	19.050 +/-0.127	BP0254-0286-0191-BSHH
25.400 (1.000") +0.000/+0.025 (mm)	28.575 +0.051/+0.076	19.050 +/-0.127	BP0254-0286-0191-BSLH
25.400 (1.000") +0.000/+0.025 (mm)	28.575 +0.051/+0.076	20.638 +/-0.127	BP0254-0286-0206-BSLH
25.400 (1.000") +0.063/+0.088 (mm)	28.575 +0.051/+0.076	22.225 +/-0.127	BP0254-0286-0222-BSHH
25.400 (1.000") +0.076/+0.102 (mm)	28.575 +0.035/+0.056	25.400 +/-0.127	BP0254-0286-0254-BSHT
25.400 (1.000") +0.000/+0.025 (mm)	28.575 +0.051/+0.076	25.400	BP0254-0286-0254-BSLH
25.400 (1.000") +0.063/+0.088 (mm)	28.575 +0.051/+0.076	31.750 +/-0.127	BP0254-0286-0318-BSHH
25.400 (1.000") +0.000/+0.025 (mm)	28.575 +0.051/+0.076	31.750 +/-0.127	BP0254-0286-0318-BSLH
25.400 (1.000") +0.000/+0.025 (mm)	28.575 +0.051/+0.076	34.925 +/-0.127	BP0254-0286-0349-BSLH
25.400 (1.000") +0.063/+0.088 (mm)	28.575 +0.051/+0.076	38.100 +/-0.127	BP0254-0286-0381-BSHH
25.400 (1.000") +0.000/+0.025 (mm)	28.575 +0.051/+0.076	38.100 +/-0.127	BP0254-0286-0381-BSLH
25.400 (1.000") +0.025/+0.051 (mm)	30.163 +0.025/+0.051	19.050	BP0254-0302-0191-BS
25.400 (1.000") +0.076/+0.102 (mm)	30.163 +0.038/+0.063	19.050 +/-0.127	BP0254-0302-0191-BSHH
25.400 (1.000") +0.076/+0.102 (mm)	30.163 +0.038/+0.063	25.400 +/-0.127	BP0254-0302-0254-BSHH
25.400 (1.000") +0.025/+0.051 (mm)	30.163 +0.025/+0.051	25.400	BP0254-0302-0254-BS
25.400 (1.000") +0.025/+0.051 (mm)	30.163 +0.025/+0.051	38.100 +/-0.127	BP0254-0302-0381-BS
25.400 (1.000") +0.025/+0.051 (mm)	30.163 +0.025/+0.051	50.800 +/-0.190	BP0254-0302-0508-BS
25.400 (1.000") +0.051/+0.076 (mm)	31.750 +0.076/+0.102	12.700 +/-0.127	BP0254-0318-0127-BSHH
25.400 (1.000") +0.000/+0.025 (mm)	31.750 +0.025/+0.051	12.700	BP0254-0318-0127-BSLT
25.400 (1.000") +0.051/+0.076 (mm)	31.750 +0.076/+0.102	19.050 +/-0.127	BP0254-0318-0191-BSHH
25.400 (1.000") +0.000/+0.025 (mm)	31.750 +0.025/+0.051	19.050 +/-0.127	BP0254-0318-0191-BSLT
25.400 (1.000") +0.025/+0.051 (mm)	31.750 +0.025/+0.051	22.225	BP0254-0318-0222-BS
25.400 (1.000") +0.076/+0.102 (mm)	31.750 +0.043/+0.068	22.225 +/-0.127	BP0254-0318-0222-BSHH
25.400 (1.000") +0.102/+0.127 (mm)	31.750 +0.038/+0.063	25.400 +/-0.127	BP0254-0318-0254-BSHH2
25.400 (1.000") +0.000/+0.025 (mm)	31.750 +0.025/+0.051	25.400 +/-0.127	BP0254-0318-0254-BSLT
25.400 (1.000") +0.051/+0.076 (mm)	31.750 +0.076/+0.102	25.400 +/-0.127	BP0254-0318-0254-BSHH1
25.400 (1.000") +0.025/+0.051 (mm)	31.750 +0.025/+0.051	25.400 +/-0.127	BP0254-0318-0254-BS

 Stocked or Short Delivery

 Usually Available Short Delivery

 Long delivery or not in current production

* Large Minimum Quantities

** Available only while stock last:

Bushes - Plain

Nominal ID (d) mm (inches)	Nominal OD (D) mm	Length (S) mm	Part Number
25.400 (1.000") +0.076/+0.102 (mm)	31.750 +0.043/+0.068	28.575 +/-0.127	BP0254-0318-0286-BSHH
25.400 (1.000") +0.025/+0.051 (mm)	31.750 +0.025/+0.051	28.575 +/-0.127	BP0254-0318-0286-BS
25.400 (1.000") +0.025/+0.051 (mm)	31.750 +0.025/+0.051	31.750 +/-0.127	BP0254-0318-0318-BS
25.400 (1.000") +0.051/+0.076 (mm)	31.750 +0.076/+0.102	31.750 +/-0.127	BP0254-0318-0318-BSHH1
25.400 (1.000") +0.102/+0.127 (mm)	31.750 +0.038/+0.063	31.750 +/-0.127	BP0254-0318-0318-BSHH2
25.400 (1.000") +0.000/+0.025 (mm)	31.750 +0.025/+0.051	31.750 +/-0.127	BP0254-0318-0318-BSLT
25.400 (1.000") +0.102/+0.127 (mm)	31.750 +0.038/+0.064	34.925	BP0254-0318-0349-BSHH2
25.400 (1.000") +0.076/+0.102 (mm)	31.750 +0.043/+0.068	34.925 +/-0.127	BP0254-0318-0349-BSHH1
25.400 (1.000") +0.051/+0.076 (mm)	31.750 +0.076/+0.102	38.100 +/-0.127	BP0254-0318-0381-BSHH1
25.400 (1.000") +0.000/+0.025 (mm)	31.750 +0.025/+0.051	38.100 +/-0.127	BP0254-0318-0381-BSLT
25.400 (1.000") +0.102/+0.127 (mm)	31.750 +0.038/+0.063	38.100 +/-0.127	BP0254-0318-0381-BSHH2
25.400 (1.000") +0.076/+0.102 (mm)	31.750 +0.043/+0.068	41.275 +/-0.190	BP0254-0318-0413-BSHH
25.400 (1.000") +0.025/+0.051 (mm)	31.750 +0.025/+0.051	44.450 +/-0.190	BP0254-0318-0445-BS
25.400 (1.000") +0.051/+0.076 (mm)	31.750 +0.051/+0.076	44.450 +/-0.190	BP0254-0318-0445-BSHH
25.400 (1.000") +0.000/+0.025 (mm)	31.750 +0.025/+0.051	44.450 +/-0.190	BP0254-0318-0445-BSLT
25.400 (1.000") +0.025/+0.051 (mm)	31.750 +0.025/+0.051	50.800 +/-0.190	BP0254-0318-0508-BS
25.400 (1.000") +0.051/+0.076 (mm)	31.750 +0.051/+0.076	50.800 +/-0.190	BP0254-0318-0508-BSHH1
25.400 (1.000") +0.076/+0.102 (mm)	31.750 +0.076/+0.102	50.800 +/-0.190	BP0254-0318-0508-BSHH2
25.400 (1.000") +0.102/+0.127 (mm)	31.750 +0.038/+0.063	50.800 +/-0.190	BP0254-0318-0508-BSHH3
25.400 (1.000") +0.000/+0.025 (mm)	31.750 +0.025/+0.051	50.800 +/-0.190	BP0254-0318-0508-BSLT
25.400 (1.000") +0.000/+0.025 (mm)	31.750 +0.025/+0.051	57.150 +/-0.190	BP0254-0318-0572-BSLT
25.400 (1.000") +0.102/+0.127 (mm)	31.750 +0.038/+0.063	57.150 +/-0.190	BP0254-0318-0572-BSHH
25.400 (1.000") +0.051/+0.076 (mm)	31.750 +0.051/+0.076	63.500 +/-0.190	BP0254-0318-0635-BSHH1
25.400 (1.000") +0.076/+0.102 (mm)	31.750 +0.076/+0.102	63.500 +/-0.190	BP0254-0318-0635-BSHH2
25.400 (1.000") +0.102/+0.127 (mm)	31.750 +0.038/+0.063	63.500 +/-0.190	BP0254-0318-0635-BSHH3
25.400 (1.000") +0.000/+0.025 (mm)	31.750 +0.025/+0.051	63.500 +/-0.190	BP0254-0318-0635-BSLT
25.400 (1.000") +0.025/+0.051 (mm)	31.750 +0.025/+0.051	63.500 +/-0.190	BP0254-0318-0635-BS
25.400 (1.000") +0.000/+0.025 (mm)	31.750 +0.025/+0.051	73.025 +/-0.190	BP0254-0318-0730-BSLT
25.400 (1.000") +0.025/+0.051 (mm)	31.750 +0.025/+0.051	76.200 +/-0.190	BP0254-0318-0762-BS
25.400 (1.000") +0.000/+0.025 (mm)	31.750 +0.025/+0.051	76.200 +/-0.190	BP0254-0318-0762-BSLT
25.400 (1.000") +0.076/+0.102 (mm)	33.338 +0.063/+0.089	25.400 +/-0.127	BP0254-0333-0254-BSHH
25.400 (1.000") +0.000/+0.025 (mm)	33.338 +0.063/+0.089	25.400 +/-0.127	BP0254-0333-0254-BSLH
25.400 (1.000") +0.025/+0.051 (mm)	33.338 +0.038/+0.063	25.400 +/-0.127	BP0254-0333-0254-BSTH
25.400 (1.000") +0.025/+0.051 (mm)	33.338 +0.038/+0.063	31.750 +/-0.127	BP0254-0333-0318-BSTH

Stocked or Short Delivery

Usually Available Short Delivery

Long delivery or not in current production

* Large Minimum Quantities

** Available only while stock last:

Bushes - Plain

Nominal ID (d) mm (inches)	Nominal OD (D) mm	Length (S) mm	Part Number
25.400 (1.000") +0.076/+0.102 (mm)	33.338 +0.063/+0.089	31.750 +/-0.127	BP0254-0333-0318-BSHH
25.400 (1.000") +0.025/+0.051 (mm)	33.338 +0.038/+0.063	38.100 +/-0.127	BP0254-0333-0381-BSTH
25.400 (1.000") +0.000/+0.025 (mm)	33.338 +0.063/+0.089	38.100 +/-0.127	BP0254-0333-0381-BSLH
25.400 (1.000") +0.076/+0.102 (mm)	33.338 +0.063/+0.089	38.100 +/-0.127	BP0254-0333-0381-BSHH
25.400 (1.000") +0.025/+0.051 (mm)	33.338 +0.038/+0.063	41.275 +/-0.190	BP0254-0333-0413-BSTH
25.400 (1.000") +0.025/+0.051 (mm)	33.338 +0.038/+0.063	44.450 +/-0.190	BP0254-0333-0445-BSTH
25.400 (1.000") +0.000/+0.025 (mm)	33.338 +0.063/+0.089	44.450 +/-0.190	BP0254-0333-0445-BSLH
25.400 (1.000") +0.076/+0.102 (mm)	33.338 +0.063/+0.089	44.450 +/-0.190	BP0254-0333-0445-BSHH
25.400 (1.000") +0.025/+0.051 (mm)	33.338 +0.038/+0.063	50.800 +/-0.190	BP0254-0333-0508-BSTH
25.400 (1.000") +0.076/+0.102 (mm)	33.338 +0.063/+0.089	50.800 +/-0.190	BP0254-0333-0508-BSHH
25.400 (1.000") +0.000/+0.025 (mm)	33.338 +0.063/+0.089	50.800 +/-0.190	BP0254-0333-0508-BSLH
25.400 (1.000") +0.025/+0.051 (mm)	33.338 +0.038/+0.063	63.500 +/-0.190	BP0254-0333-0635-BSTH
25.400 (1.000") +0.076/+0.102 (mm)	33.338 +0.063/+0.089	63.500 +/-0.190	BP0254-0333-0635-BSHH
25.400 (1.000") +0.025/+0.051 (mm)	33.338 +0.038/+0.063	69.850 +/-0.190	BP0254-0333-0699-BSTH
25.400 (1.000") +0.076/+0.102 (mm)	33.338 +0.063/+0.089	76.200 +/-0.190	BP0254-0333-0762-BSHH
25.400 (1.000") +0.025/+0.051 (mm)	33.338 +0.038/+0.063	76.200 +/-0.190	BP0254-0333-0762-BSTH
25.400 (1.000") +0.076/+0.102 (mm)	34.925 +0.076/+0.102	19.050 +/-0.127	BP0254-0349-0191-BSHH
25.400 (1.000") +0.000/+0.025 (mm)	34.925 +0.051/+0.076	19.050 +/-0.127	BP0254-0349-0191-BSLH
25.400 (1.000") +0.076/+0.102 (mm)	34.925 +0.076/+0.102	25.400 +/-0.127	BP0254-0349-0254-BSHH
25.400 (1.000") +0.051/+0.076 (mm)	34.925 +0.025/+0.051	25.400 +/-0.127	BP0254-0349-0254-BSHT
25.400 (1.000") +0.051/+0.076 (mm)	34.925 +0.025/+0.051	28.575 +/-0.127	BP0254-0349-0286-BSHT
25.400 (1.000") +0.076/+0.102 (mm)	34.925 +0.076/+0.102	31.750 +/-0.127	BP0254-0349-0318-BSHH
25.400 (1.000") +0.051/+0.076 (mm)	34.925 +0.025/+0.051	31.750 +/-0.127	BP0254-0349-0318-BSHT
25.400 (1.000") +0.025/+0.051 (mm)	34.925 +0.051/+0.076	31.750 +/-0.127	BP0254-0349-0318-BSTH
25.400 (1.000") +0.051/+0.076 (mm)	34.925 +0.025/+0.051	34.925 +/-0.127	BP0254-0349-0349-BSHT
25.400 (1.000") +0.000/+0.025 (mm)	34.925 +0.051/+0.076	38.100 +/-0.127	BP0254-0349-0381-BSLH
25.400 (1.000") +0.076/+0.102 (mm)	34.925 +0.076/+0.102	38.100 +/-0.127	BP0254-0349-0381-BSHH
25.400 (1.000") +0.051/+0.076 (mm)	34.925 +0.025/+0.051	38.100 +/-0.127	BP0254-0349-0381-BSHT
25.400 (1.000") +0.076/+0.102 (mm)	34.925 +0.076/+0.102	44.450 +/-0.190	BP0254-0349-0445-BSHH
25.400 (1.000") +0.051/+0.076 (mm)	34.925 +0.025/+0.051	44.450 +/-0.190	BP0254-0349-0445-BSHT
25.400 (1.000") +0.076/+0.102 (mm)	34.925 +0.076/+0.102	50.800 +/-0.190	BP0254-0349-0508-BSHH
25.400 (1.000") +0.051/+0.076 (mm)	34.925 +0.025/+0.051	50.800 +/-0.190	BP0254-0349-0508-BSHT
25.400 (1.000") +0.000/+0.025 (mm)	34.925 +0.051/+0.076	50.800 +/-0.190	BP0254-0349-0508-BSLH
25.400 (1.000") +0.051/+0.076 (mm)	34.925 +0.025/+0.051	57.150 +/-0.190	BP0254-0349-0572-BSHT

Stocked or Short Delivery

Usually Available Short Delivery

Long delivery or not in current production

* Large Minimum Quantities

** Available only while stock last:

Bushes - Plain

Nominal ID (d) mm (inches)	Nominal OD (D) mm	Length (S) mm	Part Number
25.400 (1.000") +0.076/+0.102 (mm)	34.925 +0.076/+0.102	63.500 +/-0.190	BP0254-0349-0635-BSHH
25.400 (1.000") +0.064/+0.089 (mm)	38.100 +0.089/+0.114	25.400	BP0254-0381-0254-BSHH2
25.400 (1.000") +0.076/+0.102 (mm)	38.100 +0.076/+0.102	25.400 +/-0.127	BP0254-0381-0254-BSHH1
25.400 (1.000") +0.064/+0.089 (mm)	38.100 +0.089/+0.114	31.750	BP0254-0381-0318-BSHH2
25.400 (1.000") +0.076/+0.102 (mm)	38.100 +0.076/+0.102	31.750 +/-0.127	BP0254-0381-0318-BSHH1
25.400 (1.000") +0.064/+0.089 (mm)	38.100 +0.089/+0.114	38.100	BP0254-0381-0381-BSHH2
25.400 (1.000") +0.076/+0.102 (mm)	38.100 +0.076/+0.102	38.100 +/-0.127	BP0254-0381-0381-BSHH1
25.400 (1.000") +0.076/+0.102 (mm)	38.100 +0.076/+0.102	44.450 +/-0.190	BP0254-0381-0445-BSHH
25.400 (1.000") +0.064/+0.089 (mm)	38.100 +0.089/+0.114	50.800	BP0254-0381-0508-BSHH2
25.400 (1.000") +0.076/+0.102 (mm)	38.100 +0.076/+0.102	50.800 +/-0.190	BP0254-0381-0508-BSHH1
25.400 (1.000") +0.076/+0.102 (mm)	38.100 +0.076/+0.102	63.500 +/-0.190	BP0254-0381-0635-BSHH
25.400 (1.000") +0.076/+0.102 (mm)	38.100 +0.076/+0.102	76.200 +/-0.190	BP0254-0381-0762-BSHH
26.988 (1.063") +0.012/+0.038 (mm)	33.338 +0.089/+0.114	19.050 +/-0.127	BP0270-0333-0191-BSLH
26.988 (1.063") +0.038/+0.063 (mm)	33.338 +0.063/+0.089	25.400 +/-0.127	BP0270-0333-0254-BSHH
26.988 (1.063") +0.012/+0.038 (mm)	33.338 +0.089/+0.114	25.400 +/-0.127	BP0270-0333-0254-BSLH
26.988 (1.063") +0.012/+0.038 (mm)	33.338 +0.089/+0.114	31.750 +/-0.127	BP0270-0333-0318-BSLH
26.988 (1.063") +0.038/+0.063 (mm)	33.338 +0.063/+0.089	38.100 +/-0.127	BP0270-0333-0381-BSHH
26.988 (1.063") +0.012/+0.038 (mm)	33.338 +0.089/+0.114	38.100 +/-0.127	BP0270-0333-0381-BSLH
26.988 (1.063") +0.038/+0.063 (mm)	33.338 +0.063/+0.089	50.800 +/-0.190	BP0270-0333-0508-BSHH
26.988 (1.063") +0.038/+0.063 (mm)	33.338 +0.063/+0.089	63.500 +/-0.190	BP0270-0333-0635-BSHH
28.000 (1.102") +0.005/+0.030 (mm)	32.000 +0.040/+0.070	22.000 +/-0.120	BP0280-0320-0220-BS
28.000 (1.102") +0.005/+0.030 (mm)	32.000 +0.040/+0.070	25.000 +/-0.120	BP0280-0320-0250-BS
28.000 (1.102") +0.005/+0.030 (mm)	32.000 +0.040/+0.070	28.000 +/-0.120	BP0280-0320-0280-BS
28.000 (1.102") +0.005/+0.030 (mm)	32.000 +0.040/+0.070	30.000 +/-0.120	BP0280-0320-0300-BS
28.000 (1.102") +0.005/+0.030 (mm)	32.000 +0.040/+0.070	36.000 +/-0.120	BP0280-0320-0360-BS
28.000 (1.102") +0.005/+0.030 (mm)	32.000 +0.040/+0.070	45.000 +/-0.190	BP0280-0320-0450-BS
28.000 (1.102") +0.005/+0.030 (mm)	33.000 +0.040/+0.070	22.000 +/-0.120	BP0280-0330-0220-BS
28.000 (1.102") +0.005/+0.030 (mm)	33.000 +0.040/+0.070	28.000 +/-0.120	BP0280-0330-0280-BS
28.000 (1.102") +0.005/+0.030 (mm)	36.000 +0.040/+0.070	22.000 +/-0.120	BP0280-0360-0220-BS
28.000 (1.102") +0.005/+0.030 (mm)	36.000 +0.040/+0.070	28.000 +/-0.120	BP0280-0360-0280-BS
28.575 (1.125") -0.038/-0.013 (mm)	31.750 +0.063/+0.089	22.225 +/-0.127	BP0286-0318-0222-BSUH
28.575 (1.125") +0.076/+0.102 (mm)	31.750 +0.076/+0.102	25.400 +/-0.127	BP0286-0318-0254-BSHH
28.575 (1.125") -0.038/-0.013 (mm)	31.750 +0.064/+0.089	25.400	BP0286-0318-0254-BSUH
28.575 (1.125") -0.038/-0.013 (mm)	31.750 +0.063/+0.089	28.575 +/-0.127	BP0286-0318-0286-BSUH

 Stocked or Short Delivery

 Usually Available Short Delivery

 Long delivery or not in current production

* Large Minimum Quantities

** Available only while stock last:

Bushes - Plain

Nominal ID (d) mm (inches)	Nominal OD (D) mm	Length (S) mm	Part Number
28.575 (1.125") +0.076/+0.102 (mm)	31.750 +0.076/+0.102	31.750 +/-0.127	BP0286-0318-0318-BSHH
28.575 (1.125") -0.038/-0.013 (mm)	31.750 +0.063/+0.089	31.750 +/-0.127	BP0286-0318-0318-BSUH
28.575 (1.125") +0.025/+0.051 (mm)	31.750 +0.038/+0.063	31.750 +/-0.127	BP0286-0318-0318-BSTH
28.575 (1.125") -0.038/-0.013 (mm)	31.750 +0.063/+0.089	38.100 +/-0.127	BP0286-0318-0381-BSUH
28.575 (1.125") +0.076/+0.102 (mm)	31.750 +0.076/+0.102	38.100 +/-0.127	BP0286-0318-0381-BSHH
28.575 (1.125") +0.025/+0.051 (mm)	31.750 +0.038/+0.063	38.100 +/-0.127	BP0286-0318-0381-BSTH
28.575 (1.125") +0.012/+0.038 (mm)	33.338 +0.051/+0.076	25.400 +/-0.127	BP0286-0333-0254-BSLH
28.575 (1.125") +0.076/+0.102 (mm)	33.338 +0.063/+0.089	25.400 +/-0.127	BP0286-0333-0254-BSHH
28.575 (1.125") +0.012/+0.038 (mm)	33.338 +0.051/+0.076	31.750 +/-0.127	BP0286-0333-0318-BSLH
28.575 (1.125") +0.076/+0.102 (mm)	33.338 +0.063/+0.089	31.750 +/-0.127	BP0286-0333-0318-BSHH
28.575 (1.125") +0.076/+0.102 (mm)	33.338 +0.063/+0.089	38.100 +/-0.127	BP0286-0333-0381-BSHH
28.575 (1.125") +0.076/+0.102 (mm)	33.338 +0.063/+0.089	44.450 +/-0.190	BP0286-0333-0445-BSHH
28.575 (1.125") +0.076/+0.102 (mm)	33.338 +0.063/+0.089	50.800 +/-0.190	BP0286-0333-0508-BSHH
28.575 (1.125") +0.076/+0.102 (mm)	34.925 +0.076/+0.102	12.700 +/-0.127	BP0286-0349-0127-BSHH
28.575 (1.125") +0.025/+0.051 (mm)	34.925 +0.025/+0.051	12.700 +/-0.127	BP0286-0349-0127-BS
28.575 (1.125") +0.076/+0.102 (mm)	34.925 +0.076/+0.102	19.050 +/-0.127	BP0286-0349-0191-BSHH
28.575 (1.125") +0.025/+0.051 (mm)	34.925 +0.025/+0.051	19.050	BP0286-0349-0191-BS
28.575 (1.125") +0.025/+0.051 (mm)	34.925 +0.025/+0.051	25.400 +/-0.127	BP0286-0349-0254-BS
28.575 (1.125") +0.051/+0.076 (mm)	34.925 +0.076/+0.102	25.400 +/-0.127	BP0286-0349-0254-BSHH1
28.575 (1.125") +0.076/+0.102 (mm)	34.925 +0.076/+0.102	25.400	BP0286-0349-0254-BSHH2
28.575 (1.125") +0.076/+0.102 (mm)	34.925 +0.076/+0.102	31.750 +/-0.127	BP0286-0349-0318-BSHH
28.575 (1.125") +0.025/+0.051 (mm)	34.925 +0.025/+0.051	31.750 +/-0.127	BP0286-0349-0318-BS
28.575 (1.125") +0.025/+0.051 (mm)	34.925 +0.025/+0.051	38.100 +/-0.127	BP0286-0349-0381-BS
28.575 (1.125") +0.076/+0.102 (mm)	34.925 +0.076/+0.102	38.100 +/-0.127	BP0286-0349-0381-BSHH
28.575 (1.125") +0.025/+0.051 (mm)	34.925 +0.025/+0.051	44.450 +/-0.190	BP0286-0349-0445-BS
28.575 (1.125") +0.076/+0.102 (mm)	34.925 +0.076/+0.102	44.450 +/-0.190	BP0286-0349-0445-BSHH
28.575 (1.125") +0.076/+0.102 (mm)	34.925 +0.076/+0.102	50.800 +/-0.190	BP0286-0349-0508-BSHH
28.575 (1.125") +0.025/+0.051 (mm)	34.925 +0.025/+0.051	50.800 +/-0.190	BP0286-0349-0508-BS
28.575 (1.125") +0.025/+0.051 (mm)	34.925 +0.025/+0.051	57.150 +/-0.190	BP0286-0349-0572-BS
28.575 (1.125") +0.076/+0.102 (mm)	34.925 +0.076/+0.102	57.150 +/-0.190	BP0286-0349-0572-BSHH
28.575 (1.125") +0.076/+0.102 (mm)	34.925 +0.076/+0.102	63.500 +/-0.190	BP0286-0349-0635-BSHH
28.575 (1.125") +0.025/+0.051 (mm)	34.925 +0.025/+0.051	63.500 +/-0.190	BP0286-0349-0635-BS
28.575 (1.125") +0.076/+0.102 (mm)	34.925 +0.076/+0.102	76.200 +/-0.190	BP0286-0349-0762-BSHH
28.575 (1.125") +0.025/+0.051 (mm)	34.925 +0.025/+0.051	76.200	BP0286-0349-0762-BS

Stocked or Short Delivery

Usually Available Short Delivery

Long delivery or not in current production

* Large Minimum Quantities

** Available only while stock last:

Page 58 of 82

E&OE

Bushes - Plain

Nominal ID (d) mm (inches)	Nominal OD (D) mm	Length (S) mm	Part Number
28.575 (1.125") +0.000/+0.025 (mm)	38.100 +0.051/+0.076	25.400 +/-0.127	BP0286-0381-0254-BSLH
28.575 (1.125") +0.025/+0.051 (mm)	38.100 +0.063/+0.089	25.400 +/-0.127	BP0286-0381-0254-BSTH
28.575 (1.125") +0.076/+0.102 (mm)	38.100 +0.076/+0.102	25.400 +/-0.127	BP0286-0381-0254-BSHH
28.575 (1.125") +0.076/+0.102 (mm)	38.100 +0.076/+0.102	31.750 +/-0.127	BP0286-0381-0318-BSHH
28.575 (1.125") +0.025/+0.051 (mm)	38.100 +0.064/+0.089	31.750	BP0286-0381-0318-BSTH
28.575 (1.125") +0.025/+0.051 (mm)	38.100 +0.063/+0.089	38.100 +/-0.127	BP0286-0381-0381-BSTH
28.575 (1.125") +0.000/+0.025 (mm)	38.100 +0.051/+0.076	38.100 +/-0.127	BP0286-0381-0381-BSLH
28.575 (1.125") +0.076/+0.102 (mm)	38.100 +0.076/+0.102	38.100 +/-0.127	BP0286-0381-0381-BSHH
28.575 (1.125") +0.076/+0.102 (mm)	38.100 +0.076/+0.102	44.450 +/-0.190	BP0286-0381-0445-BSHH
28.575 (1.125") +0.000/+0.025 (mm)	38.100 +0.051/+0.076	44.450	BP0286-0381-0445-BSLH
28.575 (1.125") +0.000/+0.025 (mm)	38.100 +0.051/+0.076	50.800	BP0286-0381-0508-BSLH
28.575 (1.125") +0.076/+0.102 (mm)	38.100 +0.076/+0.102	50.800 +/-0.190	BP0286-0381-0508-BSHH
28.575 (1.125") +0.076/+0.102 (mm)	38.100 +0.076/+0.102	63.500 +/-0.190	BP0286-0381-0635-BSHH
28.575 (1.125") +0.000/+0.025 (mm)	38.100 +0.051/+0.076	63.500	BP0286-0381-0635-BSLH
30.000 (1.181") +0.005/+0.030 (mm)	35.000 +0.040/+0.070	15.000 +/-0.120	BP0300-0350-0150-BS
30.000 (1.181") +0.005/+0.030 (mm)	35.000 +0.040/+0.070	20.000 +/-0.127	BP0300-0350-0200-BSTH
30.000 (1.181") +0.005/+0.030 (mm)	35.000 +0.040/+0.070	25.000 +/-0.127	BP0300-0350-0250-BSTH
30.000 (1.181") +0.005/+0.030 (mm)	35.000 +0.040/+0.070	30.000 +/-0.127	BP0300-0350-0300-BSTH
30.000 (1.181") +0.005/+0.030 (mm)	38.000 +0.040/+0.070	15.000 +/-0.120	BP0300-0380-0150-BS
30.000 (1.181") +0.005/+0.030 (mm)	38.000 +0.040/+0.070	20.000 +/-0.120	BP0300-0380-0200-BS
30.000 (1.181") +0.005/+0.030 (mm)	38.000 +0.040/+0.070	24.000 +/-0.120	BP0300-0380-0240-BS
30.000 (1.181") +0.005/+0.030 (mm)	38.000 +0.040/+0.070	25.000 +/-0.120	BP0300-0380-0250-BS
30.000 (1.181") +0.005/+0.030 (mm)	38.000 +0.040/+0.070	30.000 +/-0.120	BP0300-0380-0300-BS
30.000 (1.181") +0.005/+0.030 (mm)	38.000 +0.040/+0.070	38.000 +/-0.120	BP0300-0380-0380-BS
30.000 (1.181") +0.025/+0.051 (mm)	40.000 +0.043/+0.068	25.000 +/-0.127	BP0300-0400-0250-BS
30.000 (1.181") +0.005/+0.030 (mm)	40.000 +0.040/+0.070	35.000 +/-0.127	BP0300-0400-0350-BSLT
30.000 (1.181") +0.025/+0.051 (mm)	40.000 +0.043/+0.068	50.000 +/-0.190	BP0300-0400-0500-BS
30.163 (1.188") +0.012/+0.038 (mm)	33.338 +0.051/+0.076	25.400 +/-0.127	BP0302-0333-0254-BSLH
30.163 (1.188") +0.012/+0.038 (mm)	33.338 +0.051/+0.076	31.750 +/-0.127	BP0302-0333-0318-BSLH
30.163 (1.188") +0.012/+0.038 (mm)	34.925 +0.076/+0.102	38.100 +/-0.127	BP0302-0349-0381-BSLH
30.163 (1.188") +0.012/+0.038 (mm)	34.925 +0.076/+0.102	44.450 +/-0.190	BP0302-0349-0445-BSLH
30.163 (1.188") +0.089/+0.114 (mm)	36.513 +0.064/+0.089	31.750 +/-0.127	BP0302-0365-0318-BSHH
30.163 (1.188") +0.000/+0.025 (mm)	36.513 +0.064/+0.089	31.750	BP0302-0365-0318-BSLH
30.163 (1.188") +0.000/+0.025 (mm)	36.513 +0.064/+0.089	38.100	BP0302-0365-0381-BSLH

Stocked or Short Delivery

Usually Available Short Delivery

Long delivery or not in current production

* Large Minimum Quantities

** Available only while stock last:

Bushes - Plain

Nominal ID (d) mm (inches)	Nominal OD (D) mm	Length (S) mm	Part Number
30.163 (1.188") +0.089/+0.114 (mm)	36.513 +0.064/+0.089	38.100 +/-0.127	BP0302-0365-0381-BSHH
30.163 (1.188") +0.089/+0.114 (mm)	36.513 +0.064/+0.089	50.800 +/-0.190	BP0302-0365-0508-BSHH
30.163 (1.188") +0.000/+0.025 (mm)	36.513 +0.064/+0.089	50.800	BP0302-0365-0508-BSLH
30.163 (1.188") +0.089/+0.114 (mm)	36.513 +0.064/+0.089	63.500 +/-0.190	BP0302-0365-0635-BSHH
30.163 (1.188") +0.089/+0.114 (mm)	36.513 +0.064/+0.089	76.200 +/-0.190	BP0302-0365-0762-BSHH
30.163 (1.188") +0.089/+0.114 (mm)	38.100 +0.076/+0.102	25.400 +/-0.127	BP0302-0381-0254-BSHH1
30.163 (1.188") -0.013/+0.013 (mm)	38.100 +0.076/+0.102	25.400	BP0302-0381-0254-BSUH
30.163 (1.188") +0.114/+0.140 (mm)	38.100 +0.076/+0.102	25.400	BP0302-0381-0254-BSHH2
30.163 (1.188") +0.089/+0.114 (mm)	38.100 +0.076/+0.102	31.750 +/-0.127	BP0302-0381-0318-BSHH
30.163 (1.188") +0.089/+0.114 (mm)	38.100 +0.076/+0.102	38.100 +/-0.127	BP0302-0381-0381-BSHH2
30.163 (1.188") +0.038/+0.063 (mm)	38.100 +0.076/+0.102	38.100 +/-0.127	BP0302-0381-0381-BSHH1
30.163 (1.188") +0.114/+0.140 (mm)	38.100 +0.076/+0.102	38.100 +/-0.127	BP0302-0381-0381-BSHH3
30.163 (1.188") +0.089/+0.114 (mm)	38.100 +0.076/+0.102	44.450 +/-0.190	BP0302-0381-0445-BSHH
30.163 (1.188") +0.089/+0.114 (mm)	38.100 +0.076/+0.102	50.800 +/-0.190	BP0302-0381-0508-BSHH
30.163 (1.188") -0.013/+0.013 (mm)	38.100 +0.076/+0.102	50.800	BP0302-0381-0508-BSUH
30.163 (1.188") +0.089/+0.114 (mm)	38.100 +0.076/+0.102	63.500 +/-0.190	BP0302-0381-0635-BSHH
30.163 (1.188") -0.013/+0.013 (mm)	38.100 +0.076/+0.102	63.500	BP0302-0381-0635-BSUH
30.163 (1.188") +0.089/+0.114 (mm)	38.100 +0.076/+0.102	76.200 +/-0.190	BP0302-0381-0762-BSHH
31.750 (1.250") +0.012/+0.038 (mm)	36.513 +0.051/+0.076	31.750 +/-0.127	BP0318-0365-0318-BSLH
31.750 (1.250") +0.012/+0.038 (mm)	36.513 +0.051/+0.076	38.100 +/-0.127	BP0318-0365-0381-BSLH
31.750 (1.250") +0.012/+0.038 (mm)	36.513 +0.051/+0.076	44.450 +/-0.190	BP0318-0365-0445-BSLH
31.750 (1.250") +0.012/+0.038 (mm)	36.513 +0.051/+0.076	50.800 +/-0.190	BP0318-0365-0508-BSLH
31.750 (1.250") +0.012/+0.038 (mm)	36.513 +0.051/+0.076	63.500 +/-0.190	BP0318-0365-0635-BSLH
31.750 (1.250") +0.076/+0.102 (mm)	38.100 +0.076/+0.102	12.700 +/-0.127	BP0318-0381-0127-BSHH
31.750 (1.250") +0.025/+0.051 (mm)	38.100 +0.025/+0.051	12.700	BP0318-0381-0127-BS
31.750 (1.250") +0.076/+0.102 (mm)	38.100 +0.076/+0.102	15.875 +/-0.127	BP0318-0381-0159-BSHH
31.750 (1.250") +0.025/+0.051 (mm)	38.100 +0.025/+0.051	15.875	BP0318-0381-0159-BS
31.750 (1.250") +0.025/+0.051 (mm)	38.100 +0.025/+0.051	19.050 +/-0.127	BP0318-0381-0191-BS
31.750 (1.250") -0.025/+0.000 (mm)	38.100 +0.025/+0.051	19.050 +/-0.127	BP0318-0381-0191-BSUT
31.750 (1.250") +0.051/+0.076 (mm)	38.100 +0.076/+0.102	19.050 +/-0.127	BP0318-0381-0191-BSHH
31.750 (1.250") +0.025/+0.051 (mm)	38.100 +0.025/+0.051	22.225	BP0318-0381-0222-BS
31.750 (1.250") +0.076/+0.102 (mm)	38.100 +0.076/+0.102	22.225 +/-0.127	BP0318-0381-0222-BSHH
31.750 (1.250") +0.025/+0.051 (mm)	38.100 +0.025/+0.051	25.400 +/-0.127	BP0318-0381-0254-BS
31.750 (1.250") +0.051/+0.076 (mm)	38.100 +0.076/+0.102	25.400 +/-0.127	BP0318-0381-0254-BSHH

Stocked or Short Delivery

Usually Available Short Delivery

Long delivery or not in current production

* Large Minimum Quantities

** Available only while stock last:

Bushes - Plain

Nominal ID (d) mm (inches)	Nominal OD (D) mm	Length (S) mm	Part Number
31.750 (1.250") +0.076/+0.102 (mm)	38.100 +0.076/+0.102	28.575 +/-0.127	BP0318-0381-0286-BSHH
31.750 (1.250") +0.076/+0.102 (mm)	38.100 +0.076/+0.102	31.750 +/-0.127	BP0318-0381-0318-BSHH2
31.750 (1.250") -0.025/+0.000 (mm)	38.100 +0.025/+0.051	31.750 +/-0.127	BP0318-0381-0318-BSUT
31.750 (1.250") +0.063/+0.088 (mm)	38.100 +0.076/+0.102	31.750 +/-0.127	BP0318-0381-0318-BSHH1
31.750 (1.250") +0.025/+0.051 (mm)	38.100 +0.025/+0.051	31.750 +/-0.127	BP0318-0381-0318-BS
31.750 (1.250") +0.076/+0.102 (mm)	38.100 +0.076/+0.102	34.925 +/-0.127	BP0318-0381-0349-BSHH
31.750 (1.250") +0.025/+0.051 (mm)	38.100 +0.025/+0.051	34.925	BP0318-0381-0349-BS
31.750 (1.250") +0.025/+0.051 (mm)	38.100 +0.025/+0.051	38.100 +/-0.127	BP0318-0381-0381-BS
31.750 (1.250") +0.051/+0.076 (mm)	38.100 +0.076/+0.102	38.100 +/-0.127	BP0318-0381-0381-BSHH1
31.750 (1.250") +0.063/+0.088 (mm)	38.100 +0.076/+0.102	38.100 +/-0.127	BP0318-0381-0381-BSHH2
31.750 (1.250") +0.178/+0.203 (mm)	38.100 +0.076/+0.102	38.100 +/-0.127	BP0318-0381-0381-BSHH3
31.750 (1.250") +0.076/+0.102 (mm)	38.100 +0.076/+0.102	41.275 +/-0.190	BP0318-0381-0413-BSHH
31.750 (1.250") -0.025/+0.000 (mm)	38.100 +0.025/+0.051	41.275	BP0318-0381-0413-BSUT
31.750 (1.250") +0.025/+0.051 (mm)	38.100 +0.025/+0.051	44.450	BP0318-0381-0445-BS
31.750 (1.250") +0.076/+0.102 (mm)	38.100 +0.076/+0.102	44.450 +/-0.190	BP0318-0381-0445-BSHH
31.750 (1.250") +0.025/+0.051 (mm)	38.100 +0.025/+0.051	47.625	BP0318-0381-0476-BS
31.750 (1.250") +0.076/+0.102 (mm)	38.100 +0.076/+0.102	47.625 +/-0.190	BP0318-0381-0476-BSHH
31.750 (1.250") +0.076/+0.102 (mm)	38.100 +0.076/+0.102	50.800 +/-0.190	BP0318-0381-0508-BSHH
31.750 (1.250") +0.025/+0.051 (mm)	38.100 +0.025/+0.051	50.800	BP0318-0381-0508-BS
31.750 (1.250") +0.076/+0.102 (mm)	38.100 +0.076/+0.102	57.150 +/-0.190	BP0318-0381-0572-BSHH
31.750 (1.250") +0.025/+0.051 (mm)	38.100 +0.025/+0.051	63.500	BP0318-0381-0635-BS
31.750 (1.250") +0.076/+0.102 (mm)	38.100 +0.076/+0.102	63.500 +/-0.190	BP0318-0381-0635-BSHH
31.750 (1.250") +0.076/+0.102 (mm)	38.100 +0.076/+0.102	76.200 +/-0.190	BP0318-0381-0762-BSHH
31.750 (1.250") +0.076/+0.102 (mm)	39.688 +0.051/+0.089	25.400 +/-0.127	BP0318-0397-0254-BSHH
31.750 (1.250") +0.025/+0.051 (mm)	39.688 +0.038/+0.063	31.750 +/-0.127	BP0318-0397-0318-BS
31.750 (1.250") +0.076/+0.102 (mm)	39.688 +0.051/+0.089	38.100 +/-0.127	BP0318-0397-0381-BSHH
31.750 (1.250") +0.025/+0.051 (mm)	39.688 +0.025/+0.064	38.100	BP0318-0397-0381-BSTL
31.750 (1.250") +0.025/+0.051 (mm)	39.688 +0.038/+0.063	44.450 +/-0.190	BP0318-0397-0445-BS
31.750 (1.250") +0.076/+0.102 (mm)	39.688 +0.051/+0.089	50.800 +/-0.190	BP0318-0397-0508-BSHH
31.750 (1.250") +0.025/+0.051 (mm)	39.688 +0.025/+0.064	50.800	BP0318-0397-0508-BSTL
31.750 (1.250") +0.025/+0.051 (mm)	39.688 +0.038/+0.063	57.150 +/-0.190	BP0318-0397-0572-BS
31.750 (1.250") +0.025/+0.051 (mm)	41.275 +0.025/+0.064	25.400	BP0318-0413-0254-BSTL
31.750 (1.250") +0.076/+0.102 (mm)	41.275 +0.063/+0.102	25.400 +/-0.127	BP0318-0413-0254-BSHH
31.750 (1.250") +0.076/+0.102 (mm)	41.275 +0.063/+0.102	31.750 +/-0.127	BP0318-0413-0318-BSHH

Stocked or Short Delivery

Usually Available Short Delivery

Long delivery or not in current production

* Large Minimum Quantities

** Available only while stock last:

Bushes - Plain

Nominal ID (d) mm (inches)	Nominal OD (D) mm	Length (S) mm	Part Number
31.750 (1.250") +0.025/+0.051 (mm)	41.275 +0.025/+0.064	31.750	BP0318-0413-0318-BSTL
31.750 (1.250") +0.025/+0.051 (mm)	41.275 +0.038/+0.063	38.100 +/-0.127	BP0318-0413-0381-BS
31.750 (1.250") +0.076/+0.102 (mm)	41.275 +0.063/+0.102	38.100 +/-0.127	BP0318-0413-0381-BSHH
31.750 (1.250") -0.025/+0.000 (mm)	41.275 +0.025/+0.051	38.100 +/-0.127	BP0318-0413-0381-BSUL
31.750 (1.250") +0.025/+0.051 (mm)	41.275 +0.038/+0.063	41.275 +/-0.190	BP0318-0413-0413-BS
31.750 (1.250") +0.025/+0.051 (mm)	41.275 +0.038/+0.063	44.450 +/-0.190	BP0318-0413-0445-BS
31.750 (1.250") +0.076/+0.102 (mm)	41.275 +0.063/+0.102	44.450 +/-0.190	BP0318-0413-0445-BSHH
31.750 (1.250") +0.025/+0.051 (mm)	41.275 +0.025/+0.064	50.800	BP0318-0413-0508-BSTL
31.750 (1.250") +0.076/+0.102 (mm)	41.275 +0.063/+0.102	50.800 +/-0.190	BP0318-0413-0508-BSHH
31.750 (1.250") +0.025/+0.051 (mm)	41.275 +0.038/+0.076	63.500	BP0318-0413-0635-BS
31.750 (1.250") +0.076/+0.102 (mm)	41.275 +0.063/+0.102	63.500 +/-0.190	BP0318-0413-0635-BSHH
31.750 (1.250") +0.025/+0.051 (mm)	41.275 +0.025/+0.064	63.500	BP0318-0413-0635-BSTL
31.750 (1.250") +0.076/+0.102 (mm)	41.275 +0.063/+0.102	76.200 +/-0.190	BP0318-0413-0762-BSHH
31.750 (1.250") +0.025/+0.051 (mm)	41.275 +0.025/+0.064	76.200	BP0318-0413-0762-BSTL
31.750 (1.250") +0.076/+0.102 (mm)	44.450 +0.038/+0.076	38.100	BP0318-0445-0381-BSHH1
31.750 (1.250") +0.076/+0.102 (mm)	44.450 +0.063/+0.102	38.100 +/-0.127	BP0318-0445-0381-BSHH2
31.750 (1.250") +0.025/+0.051 (mm)	44.450 +0.051/+0.076	44.450 +/-0.190	BP0318-0445-0445-BS
31.750 (1.250") +0.076/+0.102 (mm)	44.450 +0.038/+0.076	50.800	BP0318-0445-0508-BSHH1
31.750 (1.250") +0.076/+0.102 (mm)	44.450 +0.063/+0.102	50.800 +/-0.190	BP0318-0445-0508-BSHH2
31.750 (1.250") +0.076/+0.102 (mm)	44.450 +0.063/+0.102	63.500 +/-0.190	BP0318-0445-0635-BSHH
31.750 (1.250") +0.076/+0.102 (mm)	44.450 +0.038/+0.076	76.200	BP0318-0445-0762-BSHH1
31.750 (1.250") +0.076/+0.102 (mm)	44.450 +0.063/+0.102	76.200 +/-0.190	BP0318-0445-0762-BSHH2
32.000 (1.260") +0.009/+0.040 (mm)	38.000 +0.040/+0.070	20.000 +/-0.120	BP0320-0380-0200-BS
32.000 (1.260") +0.009/+0.040 (mm)	38.000 +0.040/+0.070	25.000 +/-0.120	BP0320-0380-0250-BS
32.000 (1.260") +0.009/+0.040 (mm)	38.000 +0.040/+0.070	28.000 +/-0.120	BP0320-0380-0280-BS
32.000 (1.260") +0.009/+0.040 (mm)	38.000 +0.040/+0.070	32.000 +/-0.120	BP0320-0380-0320-BS
32.000 (1.260") +0.009/+0.040 (mm)	38.000 +0.040/+0.070	40.000 +/-0.190	BP0320-0380-0400-BS
32.000 (1.260") +0.009/+0.040 (mm)	38.000 +0.040/+0.070	50.000 +/-0.190	BP0320-0380-0500-BS
32.000 (1.260") +0.009/+0.040 (mm)	40.000 +0.040/+0.070	20.000 +/-0.120	BP0320-0400-0200-BS
32.000 (1.260") +0.009/+0.040 (mm)	40.000 +0.040/+0.070	25.000 +/-0.120	BP0320-0400-0250-BS
32.000 (1.260") +0.009/+0.040 (mm)	40.000 +0.040/+0.070	32.000 +/-0.120	BP0320-0400-0320-BS
32.000 (1.260") +0.009/+0.040 (mm)	40.000 +0.040/+0.070	40.000 +/-0.190	BP0320-0400-0400-BS
32.000 (1.260") +0.009/+0.040 (mm)	40.000 +0.040/+0.070	50.000 +/-0.190	BP0320-0400-0500-BS
33.338 (1.313") +0.051/+0.076 (mm)	38.100 +0.051/+0.076	25.400 +/-0.127	BP0333-0381-0254-BSHH

Stocked or Short Delivery

Usually Available Short Delivery

Long delivery or not in current production

* Large Minimum Quantities

** Available only while stock last:

Bushes - Plain

Nominal ID (d) mm (inches)	Nominal OD (D) mm	Length (S) mm	Part Number
33.338 (1.313") +0.051/+0.076 (mm)	38.100 +0.051/+0.076	31.750 +/-0.127	BP0333-0381-0318-BSHH
33.338 (1.313") +0.051/+0.076 (mm)	38.100 +0.051/+0.076	38.100 +/-0.127	BP0333-0381-0381-BSHH
33.338 (1.313") +0.051/+0.076 (mm)	38.100 +0.051/+0.076	50.800 +/-0.190	BP0333-0381-0508-BSHH
33.338 (1.313") +0.063/+0.088 (mm)	39.688 +0.051/+0.089	25.400 +/-0.127	* BP0333-0397-0254-BSHH
33.338 (1.313") +0.063/+0.088 (mm)	39.688 +0.051/+0.089	38.100 +/-0.127	* BP0333-0397-0381-BSHH
33.338 (1.313") +0.063/+0.088 (mm)	39.688 +0.051/+0.089	50.800 +/-0.190	* BP0333-0397-0508-BSHH
33.338 (1.313") +0.064/+0.089 (mm)	41.275 +0.064/+0.102	31.750 +/-0.127	BP0333-0413-0318-BSHH
33.338 (1.313") +0.051/+0.076 (mm)	41.275 +0.064/+0.102	38.100 +/-0.127	BP0333-0413-0381-BSHH
33.338 (1.313") +0.051/+0.076 (mm)	41.275 +0.064/+0.102	50.800 +/-0.190	BP0333-0413-0508-BSHH
33.338 (1.313") +0.051/+0.076 (mm)	41.275 +0.064/+0.102	63.500 +/-0.190	BP0333-0413-0635-BSHH
33.338 (1.313") +0.064/+0.089 (mm)	41.275 +0.064/+0.102	76.200 +/-0.190	BP0333-0413-0762-BSHH
34.925 (1.375") -0.038/-0.013 (mm)	39.688 +0.051/+0.076	31.750 +/-0.127	BP0349-0397-0318-BSUT
34.925 (1.375") -0.038/-0.013 (mm)	39.688 +0.051/+0.076	38.100 +/-0.127	BP0349-0397-0381-BSUT
34.925 (1.375") +0.076/+0.102 (mm)	41.275 +0.063/+0.102	25.400 +/-0.127	BP0349-0413-0254-BSHH
34.925 (1.375") +0.000/+0.025 (mm)	41.275 +0.038/+0.076	25.400	BP0349-0413-0254-BSLT
34.925 (1.375") +0.076/+0.102 (mm)	41.275 +0.063/+0.102	28.575 +/-0.127	BP0349-0413-0286-BSHH
34.925 (1.375") +0.000/+0.025 (mm)	41.275 +0.038/+0.076	28.575	BP0349-0413-0286-BSLT
34.925 (1.375") +0.076/+0.102 (mm)	41.275 +0.063/+0.102	31.750 +/-0.127	BP0349-0413-0318-BSHH
34.925 (1.375") +0.000/+0.025 (mm)	41.275 +0.038/+0.076	31.750	BP0349-0413-0318-BSLT
34.925 (1.375") +0.076/+0.102 (mm)	41.275 +0.063/+0.102	38.100 +/-0.127	BP0349-0413-0381-BSHH2
34.925 (1.375") +0.076/+0.102 (mm)	41.275 +0.051/+0.076	38.100 +/-0.127	BP0349-0413-0381-BSHH1
34.925 (1.375") +0.000/+0.025 (mm)	41.275 +0.051/+0.076	38.100	BP0349-0413-0381-BSLT
34.925 (1.375") +0.000/+0.025 (mm)	41.275 +0.051/+0.076	44.450 +/-0.190	BP0349-0413-0445-BSLT
34.925 (1.375") +0.076/+0.102 (mm)	41.275 +0.051/+0.076	50.800 +/-0.190	BP0349-0413-0508-BSHH1
34.925 (1.375") +0.076/+0.102 (mm)	41.275 +0.063/+0.102	50.800 +/-0.190	BP0349-0413-0508-BSHH2
34.925 (1.375") +0.000/+0.025 (mm)	41.275 +0.051/+0.076	50.800	BP0349-0413-0508-BSLT
34.925 (1.375") +0.076/+0.102 (mm)	41.275 +0.051/+0.076	63.500 +/-0.190	BP0349-0413-0635-BSHH1
34.925 (1.375") +0.076/+0.102 (mm)	41.275 +0.063/+0.102	63.500 +/-0.190	BP0349-0413-0635-BSHH2
34.925 (1.375") +0.000/+0.025 (mm)	41.275 +0.051/+0.076	63.500	BP0349-0413-0635-BSLT
34.925 (1.375") +0.076/+0.102 (mm)	41.275 +0.063/+0.102	76.200 +/-0.190	BP0349-0413-0762-BSHH
34.925 (1.375") +0.076/+0.102 (mm)	44.450 +0.063/+0.102	25.400 +/-0.127	BP0349-0445-0254-BSHH
34.925 (1.375") -0.013/+0.013 (mm)	44.450 +0.038/+0.076	38.100	BP0349-0445-0381-BSUT
34.925 (1.375") +0.076/+0.102 (mm)	44.450 +0.063/+0.102	38.100 +/-0.127	BP0349-0445-0381-BSHH
34.925 (1.375") +0.076/+0.102 (mm)	44.450 +0.063/+0.102	50.800 +/-0.190	BP0349-0445-0508-BSHH

 Stocked or Short Delivery

 Usually Available Short Delivery

 Long delivery or not in current production

* Large Minimum Quantities

** Available only while stock last:

Bushes - Plain

Nominal ID (d) mm (inches)	Nominal OD (D) mm	Length (S) mm	Part Number
34.925 (1.375") -0.013/+0.013 (mm)	44.450 +0.038/+0.076	50.800	BP0349-0445-0508-BSUT
34.925 (1.375") +0.076/+0.102 (mm)	44.450 +0.063/+0.102	63.500 +/-0.190	BP0349-0445-0635-BSHH
34.925 (1.375") -0.013/+0.013 (mm)	44.450 +0.038/+0.076	63.500	BP0349-0445-0635-BSUT
34.925 (1.375") +0.076/+0.102 (mm)	44.450 +0.063/+0.102	76.200 +/-0.190	BP0349-0445-0762-BSHH
35.000 (1.378") +0.009/+0.040 (mm)	44.000 +0.040/+0.070	22.000 +/-0.120	BP0350-0440-0220-BS
35.000 (1.378") +0.009/+0.040 (mm)	44.000 +0.040/+0.070	28.000 +/-0.120	BP0350-0440-0280-BS
35.000 (1.378") +0.009/+0.040 (mm)	44.000 +0.040/+0.070	35.000 +/-0.120	BP0350-0440-0350-BS
35.000 (1.378") +0.009/+0.040 (mm)	45.000 +0.040/+0.070	25.000 +/-0.120	BP0350-0450-0250-BS
35.000 (1.378") +0.009/+0.040 (mm)	45.000 +0.040/+0.070	35.000 +/-0.120	BP0350-0450-0350-BS
35.000 (1.378") +0.009/+0.040 (mm)	45.000 +0.040/+0.070	40.000 +/-0.190	BP0350-0450-0400-BS
35.000 (1.378") +0.009/+0.040 (mm)	45.000 +0.040/+0.070	45.000 +/-0.190	BP0350-0450-0450-BS
35.000 (1.378") +0.009/+0.040 (mm)	45.000 +0.040/+0.070	50.000 +/-0.190	BP0350-0450-0500-BS
36.000 (1.417") +0.009/+0.040 (mm)	42.000 +0.040/+0.070	22.000 +/-0.120	BP0360-0420-0220-BS
36.000 (1.417") +0.009/+0.040 (mm)	42.000 +0.040/+0.070	28.000 +/-0.120	BP0360-0420-0280-BS
36.000 (1.417") +0.009/+0.040 (mm)	42.000 +0.040/+0.070	36.000 +/-0.120	BP0360-0420-0360-BS
36.000 (1.417") +0.009/+0.040 (mm)	42.000 +0.040/+0.070	45.000 +/-0.190	BP0360-0420-0450-BS
36.000 (1.417") +0.009/+0.040 (mm)	45.000 +0.040/+0.070	22.000 +/-0.120	BP0360-0450-0220-BS
36.000 (1.417") +0.009/+0.040 (mm)	45.000 +0.040/+0.070	28.000 +/-0.120	BP0360-0450-0280-BS
36.000 (1.417") +0.009/+0.040 (mm)	45.000 +0.040/+0.070	36.000 +/-0.120	BP0360-0450-0360-BS
36.000 (1.417") +0.009/+0.040 (mm)	45.000 +0.040/+0.070	45.000 +/-0.190	BP0360-0450-0450-BS
36.513 (1.438") -0.013/+0.013 (mm)	41.275 +0.038/+0.076	25.400	BP0365-0413-0254-BSUT
36.513 (1.438") +0.089/+0.114 (mm)	41.275 +0.064/+0.102	25.400 +/-0.127	BP0365-0413-0254-BSHH
36.513 (1.438") -0.013/+0.013 (mm)	41.275 +0.038/+0.076	38.100	BP0365-0413-0381-BSUT
36.513 (1.438") +0.089/+0.114 (mm)	41.275 +0.064/+0.102	38.100 +/-0.127	BP0365-0413-0381-BSHH
36.513 (1.438") +0.089/+0.114 (mm)	41.275 +0.064/+0.102	50.800 +/-0.190	BP0365-0413-0508-BSHH
36.513 (1.438") -0.013/+0.013 (mm)	41.275 +0.038/+0.076	50.800	BP0365-0413-0508-BSUT
36.513 (1.438") -0.013/+0.013 (mm)	41.275 +0.051/+0.076	57.150 +/-0.190	BP0365-0413-0572-BSUT
36.513 (1.438") +0.089/+0.114 (mm)	44.450 +0.064/+0.102	19.050 +/-0.127	BP0365-0445-0191-BSHH
36.513 (1.438") +0.102/+0.127 (mm)	44.450 +0.063/+0.089	22.225 +/-0.127	BP0365-0445-0222-BSHH
36.513 (1.438") +0.089/+0.114 (mm)	44.450 +0.064/+0.102	25.400 +/-0.127	BP0365-0445-0254-BSHH
36.513 (1.438") +0.102/+0.127 (mm)	44.450 +0.063/+0.089	28.575 +/-0.127	BP0365-0445-0286-BSHH
36.513 (1.438") -0.013/+0.013 (mm)	44.450 +0.051/+0.089	31.750	BP0365-0445-0318-BSUH
36.513 (1.438") +0.089/+0.114 (mm)	44.450 +0.064/+0.102	31.750 +/-0.127	BP0365-0445-0318-BSHH
36.513 (1.438") +0.102/+0.127 (mm)	44.450 +0.063/+0.089	38.100 +/-0.127	BP0365-0445-0381-BSHH

Stocked or Short Delivery

Usually Available Short Delivery

Long delivery or not in current production

* Large Minimum Quantities

** Available only while stock last:

Page 64 of 82

E&OE

Bushes - Plain

Nominal ID (d) mm (inches)	Nominal OD (D) mm	Length (S) mm	Part Number
36.513 (1.438") +0.089/+0.114 (mm)	44.450 +0.064/+0.102	44.450 +/-0.190	BP0365-0445-0445-BSHH
36.513 (1.438") -0.013/+0.013 (mm)	44.450 +0.051/+0.089	44.450	BP0365-0445-0445-BSUH
36.513 (1.438") +0.102/+0.127 (mm)	44.450 +0.063/+0.089	47.625 +/-0.190	BP0365-0445-0476-BSHH
36.513 (1.438") -0.013/+0.013 (mm)	44.450 +0.051/+0.089	50.800	BP0365-0445-0508-BSUH
36.513 (1.438") +0.089/+0.114 (mm)	44.450 +0.064/+0.102	50.800 +/-0.190	BP0365-0445-0508-BSHH
36.513 (1.438") +0.102/+0.127 (mm)	44.450 +0.063/+0.089	57.150 +/-0.190	BP0365-0445-0572-BSHH
36.513 (1.438") -0.013/+0.013 (mm)	44.450 +0.051/+0.089	63.500	BP0365-0445-0635-BSUH
36.513 (1.438") +0.089/+0.114 (mm)	44.450 +0.064/+0.102	63.500 +/-0.190	BP0365-0445-0635-BSHH
36.513 (1.438") +0.089/+0.114 (mm)	44.450 +0.064/+0.102	76.200 +/-0.190	BP0365-0445-0762-BSHH
38.000 (1.496") +0.009/+0.040 (mm)	44.000 +0.040/+0.070	25.000 +/-0.120	BP0380-0440-0250-BS
38.000 (1.496") +0.009/+0.040 (mm)	44.000 +0.040/+0.070	35.000 +/-0.120	BP0380-0440-0350-BS
38.000 (1.496") +0.009/+0.040 (mm)	44.000 +0.040/+0.070	45.000 +/-0.190	BP0380-0440-0450-BS
38.100 (1.500") +0.152/+0.178 (mm)	42.863 +0.063/+0.089	19.050 +/-0.127	BP0381-0429-0191-BSHH
38.100 (1.500") +0.152/+0.178 (mm)	42.863 +0.063/+0.089	25.400 +/-0.127	BP0381-0429-0254-BSHH
38.100 (1.500") +0.051/+0.076 (mm)	44.450 +0.064/+0.102	12.700	BP0381-0445-0127-BSHH2
38.100 (1.500") +0.076/+0.102 (mm)	44.450 +0.063/+0.102	12.700 +/-0.127	BP0381-0445-0127-BSHH1
38.100 (1.500") +0.051/+0.076 (mm)	44.450 +0.076/+0.102	15.875 +/-0.127	BP0381-0445-0159-BSHH
38.100 (1.500") +0.076/+0.102 (mm)	44.450 +0.063/+0.102	19.050 +/-0.127	BP0381-0445-0191-BSHH1
38.100 (1.500") +0.051/+0.076 (mm)	44.450 +0.064/+0.102	19.050	BP0381-0445-0191-BSHH2
38.100 (1.500") +0.051/+0.076 (mm)	44.450 +0.076/+0.102	22.225 +/-0.127	BP0381-0445-0222-BSHH
38.100 (1.500") +0.051/+0.076 (mm)	44.450 +0.076/+0.102	25.400 +/-0.127	BP0381-0445-0254-BSHH1
38.100 (1.500") +0.051/+0.076 (mm)	44.450 +0.064/+0.102	25.400	BP0381-0445-0254-BSHH2
38.100 (1.500") +0.051/+0.076 (mm)	44.450 +0.076/+0.102	28.575 +/-0.127	BP0381-0445-0286-BSHH
38.100 (1.500") +0.076/+0.102 (mm)	44.450 +0.063/+0.102	31.750 +/-0.127	BP0381-0445-0318-BSHH1
38.100 (1.500") +0.051/+0.076 (mm)	44.450 +0.064/+0.102	31.750	BP0381-0445-0318-BSHH2
38.100 (1.500") +0.076/+0.102 (mm)	44.450 +0.063/+0.102	34.925 +/-0.127	BP0381-0445-0349-BSHH1
38.100 (1.500") +0.051/+0.076 (mm)	44.450 +0.064/+0.102	34.925	BP0381-0445-0349-BSHH2
38.100 (1.500") +0.051/+0.076 (mm)	44.450 +0.064/+0.102	38.100	BP0381-0445-0381-BSHH2
38.100 (1.500") +0.051/+0.076 (mm)	44.450 +0.076/+0.102	38.100 +/-0.127	BP0381-0445-0381-BSHH1
38.100 (1.500") +0.076/+0.102 (mm)	44.450 +0.063/+0.102	44.450 +/-0.190	BP0381-0445-0445-BSHH1
38.100 (1.500") +0.051/+0.076 (mm)	44.450 +0.064/+0.102	44.450	BP0381-0445-0445-BSHH2
38.100 (1.500") +0.076/+0.102 (mm)	44.450 +0.063/+0.102	50.800 +/-0.190	BP0381-0445-0508-BSHH
38.100 (1.500") +0.051/+0.076 (mm)	44.450 +0.076/+0.102	50.800 +/-0.190	BP0381-0445-0508-BSHH1
38.100 (1.500") +0.051/+0.076 (mm)	44.450 +0.076/+0.102	50.800 +/-0.190	BP0381-0445-0508-BSHH2

Stocked or Short Delivery

Usually Available Short Delivery

Long delivery or not in current production

* Large Minimum Quantities

** Available only while stock last:

Bushes - Plain

Nominal ID (d) mm (inches)	Nominal OD (D) mm	Length (S) mm	Part Number
38.100 (1.500") +0.051/+0.076 (mm)	44.450 +0.064/+0.102	57.150	BP0381-0445-0572-BSHH2
38.100 (1.500") +0.076/+0.102 (mm)	44.450 +0.063/+0.102	57.150 +/-0.190	BP0381-0445-0572-BSHH1
38.100 (1.500") +0.076/+0.102 (mm)	44.450 +0.063/+0.102	63.500 +/-0.190	BP0381-0445-0635-BSHH1
38.100 (1.500") +0.051/+0.076 (mm)	44.450 +0.064/+0.102	63.500	BP0381-0445-0635-BSHH2
38.100 (1.500") +0.051/+0.076 (mm)	44.450 +0.064/+0.102	76.200	BP0381-0445-0762-BSHH2
38.100 (1.500") +0.076/+0.102 (mm)	44.450 +0.063/+0.102	76.200 +/-0.190	BP0381-0445-0762-BSHH1
38.100 (1.500") +0.051/+0.076 (mm)	44.450 +0.076/+0.102	88.900 +/-0.254	BP0381-0445-0889-BSHH
38.100 (1.500") +0.076/+0.102 (mm)	46.038 +0.051/+0.089	25.400 +/-0.127	BP0381-0460-0254-BSHH
38.100 (1.500") +0.025/+0.051 (mm)	46.038 +0.025/+0.064	25.400	BP0381-0460-0254-BSTL
38.100 (1.500") +0.076/+0.102 (mm)	46.038 +0.051/+0.089	38.100 +/-0.127	BP0381-0460-0381-BSHH
38.100 (1.500") +0.076/+0.102 (mm)	46.038 +0.051/+0.089	41.275 +/-0.190	BP0381-0460-0413-BSHH
38.100 (1.500") +0.025/+0.051 (mm)	46.038 +0.025/+0.064	41.275	BP0381-0460-0413-BSTL
38.100 (1.500") +0.076/+0.102 (mm)	46.038 +0.051/+0.089	50.800 +/-0.190	BP0381-0460-0508-BSHH
38.100 (1.500") +0.076/+0.102 (mm)	46.038 +0.051/+0.089	76.200 +/-0.190	BP0381-0460-0762-BSHH
38.100 (1.500") +0.076/+0.102 (mm)	47.625 +0.063/+0.102	38.100 +/-0.127	BP0381-0476-0381-BSHH
38.100 (1.500") +0.051/+0.076 (mm)	47.625 +0.038/+0.076	38.100	BP0381-0476-0381-BSHT
38.100 (1.500") +0.051/+0.076 (mm)	47.625 +0.051/+0.076	44.450 +/-0.190	BP0381-0476-0445-BSHT
38.100 (1.500") +0.076/+0.102 (mm)	47.625 +0.063/+0.102	50.800 +/-0.190	BP0381-0476-0508-BSHH
38.100 (1.500") +0.051/+0.076 (mm)	47.625 +0.038/+0.076	50.800	BP0381-0476-0508-BSHT
38.100 (1.500") +0.076/+0.102 (mm)	47.625 +0.063/+0.102	63.500 +/-0.190	BP0381-0476-0635-BSHH
38.100 (1.500") +0.051/+0.076 (mm)	47.625 +0.038/+0.076	63.500	BP0381-0476-0635-BSHT
38.100 (1.500") +0.051/+0.076 (mm)	47.625 +0.038/+0.076	69.850	BP0381-0476-0699-BSHT
38.100 (1.500") +0.076/+0.102 (mm)	47.625 +0.063/+0.102	69.850 +/-0.190	BP0381-0476-0699-BSHH
38.100 (1.500") +0.076/+0.102 (mm)	47.625 +0.063/+0.102	76.200 +/-0.190	BP0381-0476-0762-BSHH
38.100 (1.500") +0.051/+0.076 (mm)	47.625 +0.038/+0.076	76.200	BP0381-0476-0762-BSHT
38.100 (1.500") +0.051/+0.076 (mm)	50.800 +0.064/+0.102	25.400	BP0381-0508-0254-BSHH2
38.100 (1.500") +0.076/+0.102 (mm)	50.800 +0.063/+0.102	25.400 +/-0.127	BP0381-0508-0254-BSHH1
38.100 (1.500") +0.076/+0.102 (mm)	50.800 +0.063/+0.102	38.100 +/-0.127	BP0381-0508-0381-BSHH
38.100 (1.500") +0.076/+0.102 (mm)	50.800 +0.063/+0.102	50.800 +/-0.190	BP0381-0508-0508-BSHH1
38.100 (1.500") +0.051/+0.076 (mm)	50.800 +0.064/+0.102	50.800	BP0381-0508-0508-BSHH2
38.100 (1.500") +0.076/+0.102 (mm)	50.800 +0.063/+0.102	63.500 +/-0.190	BP0381-0508-0635-BSHH1
38.100 (1.500") +0.051/+0.076 (mm)	50.800 +0.064/+0.102	63.500	BP0381-0508-0635-BSHH2
38.100 (1.500") +0.076/+0.102 (mm)	50.800 +0.063/+0.102	76.200 +/-0.190	BP0381-0508-0762-BSHH
38.100 (1.500") +0.051/+0.076 (mm)	50.800 +0.064/+0.102	88.900	BP0381-0508-0889-BSHH2

 Stocked or Short Delivery

 Usually Available Short Delivery

 Long delivery or not in current production

* Large Minimum Quantities

** Available only while stock last:

Bushes - Plain

Nominal ID (d) mm (inches)	Nominal OD (D) mm	Length (S) mm	Part Number
38.100 (1.500") +0.076/+0.102 (mm)	50.800 +0.063/+0.102	88.900 +/-0.254	BP0381-0508-0889-BSHH1
40.000 (1.575") +0.009/+0.040 (mm)	46.000 +0.040/+0.070	25.000 +/-0.120	BP0400-0460-0250-BS
40.000 (1.575") +0.009/+0.040 (mm)	46.000 +0.040/+0.070	30.000 +/-0.127	BP0400-0460-0300-BS
40.000 (1.575") +0.009/+0.040 (mm)	46.000 +0.040/+0.070	32.000 +/-0.120	BP0400-0460-0320-BS
40.000 (1.575") +0.009/+0.040 (mm)	46.000 +0.040/+0.070	40.000 +/-0.190	BP0400-0460-0400-BS
40.000 (1.575") +0.009/+0.040 (mm)	46.000 +0.040/+0.070	50.000 +/-0.190	BP0400-0460-0500-BS
40.000 (1.575") +0.009/+0.040 (mm)	50.000 +0.040/+0.070	25.000 +/-0.127	BP0400-0500-0250-BS
40.000 (1.575") +0.009/+0.040 (mm)	50.000 +0.040/+0.070	30.000 +/-0.127	BP0400-0500-0300-BS
40.000 (1.575") +0.009/+0.040 (mm)	50.000 +0.040/+0.070	32.000 +/-0.120	BP0400-0500-0320-BS
40.000 (1.575") +0.009/+0.040 (mm)	50.000 +0.040/+0.070	35.000 +/-0.127	BP0400-0500-0350-BS
40.000 (1.575") +0.009/+0.040 (mm)	50.000 +0.040/+0.070	40.000 +/-0.190	BP0400-0500-0400-BS
40.000 (1.575") +0.009/+0.040 (mm)	50.000 +0.040/+0.070	50.000 +/-0.190	BP0400-0500-0500-BS
40.000 (1.575") +0.009/+0.040 (mm)	50.000 +0.040/+0.070	60.000 +/-0.190	BP0400-0500-0600-BS
41.275 (1.625") +0.025/+0.051 (mm)	47.625 +0.076/+0.102	25.400 +/-0.127	BP0413-0476-0254-BSLH
41.275 (1.625") +0.064/+0.102 (mm)	47.625 +0.064/+0.102	31.750 +/-0.127	BP0413-0476-0318-BSHH
41.275 (1.625") +0.013/+0.051 (mm)	47.625 +0.064/+0.102	31.750	BP0413-0476-0318-BSLH
41.275 (1.625") +0.064/+0.102 (mm)	47.625 +0.064/+0.102	38.100 +/-0.127	BP0413-0476-0381-BSHH
41.275 (1.625") +0.013/+0.051 (mm)	47.625 +0.064/+0.102	38.100	BP0413-0476-0381-BSLH
41.275 (1.625") +0.064/+0.102 (mm)	47.625 +0.064/+0.102	44.450 +/-0.190	BP0413-0476-0445-BSHH
41.275 (1.625") +0.013/+0.051 (mm)	47.625 +0.064/+0.102	44.450	BP0413-0476-0445-BSLH
41.275 (1.625") +0.064/+0.102 (mm)	47.625 +0.064/+0.102	50.800 +/-0.190	BP0413-0476-0508-BSHH
41.275 (1.625") +0.013/+0.051 (mm)	47.625 +0.064/+0.102	50.800	BP0413-0476-0508-BSLH
41.275 (1.625") +0.064/+0.102 (mm)	47.625 +0.064/+0.102	57.150 +/-0.190	BP0413-0476-0572-BSHH
41.275 (1.625") +0.013/+0.051 (mm)	47.625 +0.064/+0.102	57.150	BP0413-0476-0572-BSLH
41.275 (1.625") +0.064/+0.102 (mm)	47.625 +0.064/+0.102	63.500 +/-0.190	BP0413-0476-0635-BSHH
41.275 (1.625") +0.025/+0.051 (mm)	47.625 +0.076/+0.102	69.850 +/-0.190	BP0413-0476-0699-BSLH
41.275 (1.625") +0.064/+0.102 (mm)	47.625 +0.064/+0.102	76.200 +/-0.190	BP0413-0476-0762-BSHH
41.275 (1.625") +0.064/+0.102 (mm)	50.800 +0.064/+0.102	25.400 +/-0.127	BP0413-0508-0254-BSHH
41.275 (1.625") +0.064/+0.102 (mm)	50.800 +0.064/+0.102	38.100 +/-0.127	BP0413-0508-0381-BSHH
41.275 (1.625") +0.000/+0.038 (mm)	50.800 +0.064/+0.102	38.100	BP0413-0508-0381-BSLH
41.275 (1.625") +0.064/+0.102 (mm)	50.800 +0.064/+0.102	44.450 +/-0.190	BP0413-0508-0445-BSHH
41.275 (1.625") +0.064/+0.102 (mm)	50.800 +0.064/+0.102	50.800 +/-0.190	BP0413-0508-0508-BSHH
41.275 (1.625") +0.000/+0.038 (mm)	50.800 +0.064/+0.102	50.800	BP0413-0508-0508-BSLH
41.275 (1.625") +0.064/+0.102 (mm)	50.800 +0.064/+0.102	63.500 +/-0.190	BP0413-0508-0635-BSHH

 Stocked or Short Delivery

 Usually Available Short Delivery

 Long delivery or not in current production

* Large Minimum Quantities

** Available only while stock last:

Bushes - Plain

Nominal ID (d) mm (inches)	Nominal OD (D) mm	Length (S) mm	Part Number
41.275 (1.625") +0.000/+0.038 (mm)	50.800 +0.064/+0.102	63.500	BP0413-0508-0635-BSLH
41.275 (1.625") +0.064/+0.102 (mm)	50.800 +0.064/+0.102	76.200 +/-0.190	BP0413-0508-0762-BSHH
41.275 (1.625") +0.000/+0.038 (mm)	50.800 +0.064/+0.102	76.200	BP0413-0508-0762-BSLH
42.863 (1.688") +0.064/+0.102 (mm)	55.563 +0.089/+0.127	44.450 +/-0.190	BP0429-0556-0445-BSHH
42.863 (1.688") +0.038/+0.076 (mm)	55.563 +0.064/+0.102	50.800	BP0429-0556-0508-BSTH
42.863 (1.688") +0.064/+0.102 (mm)	55.563 +0.089/+0.127	50.800 +/-0.190	BP0429-0556-0508-BSHH
42.863 (1.688") +0.064/+0.102 (mm)	55.563 +0.089/+0.127	76.200 +/-0.190	BP0429-0556-0762-BSHH
42.863 (1.688") +0.064/+0.102 (mm)	55.563 +0.089/+0.127	101.600 +/-0.254	BP0429-0556-1016-BSHH
42.863 (1.688") +0.038/+0.076 (mm)	55.563 +0.064/+0.102	101.600	BP0429-0556-1016-BSTH
44.450 (1.750") +0.038/+0.063 (mm)	49.213 +0.076/+0.101	31.750 +/-0.127	BP0445-0492-0318-BSTH
44.450 (1.750") +0.038/+0.063 (mm)	49.213 +0.076/+0.101	38.100 +/-0.127	BP0445-0492-0381-BSTH
44.450 (1.750") +0.064/+0.102 (mm)	50.800 +0.064/+0.102	25.400 +/-0.127	BP0445-0508-0254-BSHH
44.450 (1.750") +0.038/+0.076 (mm)	50.800 +0.064/+0.102	25.400	BP0445-0508-0254-BSTH
44.450 (1.750") +0.064/+0.102 (mm)	50.800 +0.064/+0.102	31.750 +/-0.127	BP0445-0508-0318-BSHH
44.450 (1.750") +0.064/+0.102 (mm)	50.800 +0.064/+0.102	38.100 +/-0.127	BP0445-0508-0381-BSHH
44.450 (1.750") +0.038/+0.076 (mm)	50.800 +0.064/+0.102	38.100	BP0445-0508-0381-BSTH
44.450 (1.750") +0.064/+0.102 (mm)	50.800 +0.064/+0.102	44.450 +/-0.190	BP0445-0508-0445-BSHH
44.450 (1.750") +0.051/+0.076 (mm)	50.800 +0.076/+0.102	47.625 +/-0.190	BP0445-0508-0476-BSTH
44.450 (1.750") +0.038/+0.076 (mm)	50.800 +0.064/+0.102	50.800	BP0445-0508-0508-BSTH
44.450 (1.750") +0.064/+0.102 (mm)	50.800 +0.064/+0.102	50.800 +/-0.190	BP0445-0508-0508-BSHH
44.450 (1.750") +0.064/+0.102 (mm)	50.800 +0.064/+0.102	63.500 +/-0.190	BP0445-0508-0635-BSHH
44.450 (1.750") +0.038/+0.076 (mm)	50.800 +0.064/+0.102	63.500	BP0445-0508-0635-BSTH
44.450 (1.750") +0.051/+0.076 (mm)	50.800 +0.076/+0.102	69.850 +/-0.190	BP0445-0508-0699-BSTH
44.450 (1.750") +0.064/+0.102 (mm)	50.800 +0.064/+0.102	76.200 +/-0.190	BP0445-0508-0762-BSHH
44.450 (1.750") +0.038/+0.076 (mm)	50.800 +0.064/+0.102	76.200	BP0445-0508-0762-BSTH
44.450 (1.750") +0.076/+0.102 (mm)	53.975 +0.051/+0.076	12.700 +/-0.127	BP0445-0540-0127-BSHT
44.450 (1.750") +0.064/+0.102 (mm)	53.975 +0.064/+0.102	34.925 +/-0.127	BP0445-0540-0349-BSHH
44.450 (1.750") +0.064/+0.102 (mm)	53.975 +0.064/+0.102	38.100 +/-0.127	BP0445-0540-0381-BSHH
44.450 (1.750") +0.064/+0.102 (mm)	53.975 +0.038/+0.076	38.100 +/-0.127	BP0445-0540-0381-BSHT
44.450 (1.750") +0.064/+0.102 (mm)	53.975 +0.064/+0.102	50.800 +/-0.190	BP0445-0540-0508-BSHH
44.450 (1.750") +0.064/+0.102 (mm)	53.975 +0.038/+0.076	50.800 +/-0.190	BP0445-0540-0508-BSHT
44.450 (1.750") +0.076/+0.102 (mm)	53.975 +0.051/+0.076	63.500 +/-0.190	BP0445-0540-0635-BSHT
44.450 (1.750") +0.064/+0.102 (mm)	53.975 +0.064/+0.102	76.200 +/-0.190	BP0445-0540-0762-BSHH
44.450 (1.750") +0.051/+0.076 (mm)	57.150 +0.051/+0.076	50.800 +/-0.190	BP0445-0572-0508-BS

 Stocked or Short Delivery

 Usually Available Short Delivery

 Long delivery or not in current production

* Large Minimum Quantities

** Available only while stock last:

Page 68 of 82

E&OE

Bushes - Plain

Nominal ID (d) mm (inches)	Nominal OD (D) mm	Length (S) mm	Part Number
44.450 (1.750") +0.051/+0.076 (mm)	57.150 +0.051/+0.076	63.500 +/-0.190	BP0445-0572-0635-BS
44.450 (1.750") +0.051/+0.076 (mm)	57.150 +0.051/+0.076	76.200 +/-0.190	BP0445-0572-0762-BS
45.000 (1.772") +0.009/+0.040 (mm)	51.000 +0.050/+0.083	28.000 +/-0.120	BP0450-0510-0280-BS
45.000 (1.772") +0.009/+0.040 (mm)	51.000 +0.050/+0.083	35.000 +/-0.127	BP0450-0510-0350-BSTH
45.000 (1.772") +0.009/+0.040 (mm)	51.000 +0.050/+0.083	36.000 +/-0.120	BP0450-0510-0360-BS
45.000 (1.772") +0.009/+0.040 (mm)	51.000 +0.050/+0.083	45.000 +/-0.190	BP0450-0510-0450-BSTH
45.000 (1.772") +0.009/+0.040 (mm)	51.000 +0.050/+0.083	55.000 +/-0.190	BP0450-0510-0550-BSTH
45.000 (1.772") +0.009/+0.040 (mm)	51.000 +0.050/+0.083	56.000 +/-0.250	BP0450-0510-0560-BS
45.000 (1.772") +0.051/+0.076 (mm)	55.000 +0.053/+0.099	35.000 +/-0.127	BP0450-0550-0350-BSTH
45.000 (1.772") +0.051/+0.076 (mm)	55.000 +0.053/+0.099	45.000 +/-0.190	BP0450-0550-0450-BSTH
45.000 (1.772") +0.051/+0.076 (mm)	55.000 +0.053/+0.099	55.000 +/-0.190	BP0450-0550-0550-BSTH
47.625 (1.875") +0.051/+0.076 (mm)	57.150 +0.076/+0.102	19.050 +/-0.127	BP0476-0572-0191-BSTH
47.625 (1.875") +0.051/+0.076 (mm)	57.150 +0.076/+0.102	50.800 +/-0.190	BP0476-0572-0508-BSTH
47.625 (1.875") +0.051/+0.076 (mm)	57.150 +0.076/+0.102	63.500 +/-0.190	BP0476-0572-0635-BSTH
47.625 (1.875") +0.051/+0.076 (mm)	57.150 +0.076/+0.102	76.200 +/-0.190	BP0476-0572-0762-BSTH
49.213 (1.938") +0.038/+0.063 (mm)	53.975 +0.063/+0.089	50.800 +/-0.190	BP0492-0540-0508-BSTH
49.213 (1.938") +0.025/+0.064 (mm)	53.975 +0.051/+0.089	63.500	BP0492-0540-0635-BSLH
49.213 (1.938") +0.051/+0.076 (mm)	58.738 +0.063/+0.102	50.800 +/-0.190	BP0492-0587-0508-BSTH
49.213 (1.938") +0.038/+0.076 (mm)	58.738 +0.064/+0.102	63.500 +/-0.190	BP0492-0587-0635-BSTH
49.213 (1.938") +0.051/+0.076 (mm)	58.738 +0.063/+0.102	76.200 +/-0.190	BP0492-0587-0762-BSTH
49.213 (1.938") +0.051/+0.076 (mm)	58.738 +0.063/+0.102	101.600 +/-0.254	BP0492-0587-1016-BSTH
49.213 (1.938") +0.088/+0.114 (mm)	61.913 +0.076/+0.101	38.100 +/-0.127	BP0492-0619-0381-BSHH
49.213 (1.938") +0.088/+0.114 (mm)	61.913 +0.076/+0.101	50.800 +/-0.190	BP0492-0619-0508-BSHH
50.000 (1.969") +0.051/+0.076 (mm)	60.000 +0.053/+0.099	30.000 +/-0.127	BP0500-0600-0300-BSTH
50.000 (1.969") +0.051/+0.076 (mm)	60.000 +0.053/+0.099	35.000 +/-0.127	BP0500-0600-0350-BSTH
50.000 (1.969") +0.009/+0.040 (mm)	60.000 +0.040/+0.070	40.000 +/-0.190	BP0500-0600-0400-BSTH
50.000 (1.969") +0.051/+0.076 (mm)	60.000 +0.053/+0.099	50.000 +/-0.190	BP0500-0600-0500-BSTH
50.800 (2.000") +0.051/+0.076 (mm)	57.150 +0.076/+0.102	19.050 +/-0.127	BP0508-0572-0191-BSTH
50.800 (2.000") +0.063/+0.102 (mm)	57.150 +0.076/+0.127	25.400 +/-0.127	BP0508-0572-0254-BSHT
50.800 (2.000") +0.038/+0.076 (mm)	57.150 +0.064/+0.102	25.400	BP0508-0572-0254-BSTH
50.800 (2.000") +0.063/+0.102 (mm)	57.150 +0.076/+0.127	38.100 +/-0.127	BP0508-0572-0381-BSHT
50.800 (2.000") +0.038/+0.076 (mm)	57.150 +0.064/+0.102	38.100	BP0508-0572-0381-BSTH
50.800 (2.000") +0.063/+0.102 (mm)	57.150 +0.076/+0.127	50.800 +/-0.190	BP0508-0572-0508-BSHT
50.800 (2.000") +0.038/+0.076 (mm)	57.150 +0.064/+0.102	50.800	BP0508-0572-0508-BSTH

 Stocked or Short Delivery

 Usually Available Short Delivery

 Long delivery or not in current production

* Large Minimum Quantities

** Available only while stock last:

Bushes - Plain

Nominal ID (d) mm (inches)	Nominal OD (D) mm	Length (S) mm	Part Number
50.800 (2.000") +0.038/+0.076 (mm)	57.150 +0.064/+0.102	63.500	BP0508-0572-0635-BSTH
50.800 (2.000") +0.064/+0.102 (mm)	57.150 +0.064/+0.102	63.500 +/-0.190	BP0508-0572-0635-BSHH
50.800 (2.000") +0.064/+0.102 (mm)	57.150 +0.064/+0.102	76.200 +/-0.190	BP0508-0572-0762-BSHH
50.800 (2.000") +0.038/+0.076 (mm)	57.150 +0.064/+0.102	76.200	BP0508-0572-0762-BSTH
50.800 (2.000") +0.051/+0.076 (mm)	60.325 +0.076/+0.102	28.575 +/-0.127	BP0508-0603-0286-BSTH
50.800 (2.000") +0.063/+0.102 (mm)	60.325 +0.076/+0.127	38.100 +/-0.127	BP0508-0603-0381-BSHT
50.800 (2.000") +0.038/+0.076 (mm)	60.325 +0.064/+0.102	38.100	BP0508-0603-0381-BSTH
50.800 (2.000") +0.064/+0.102 (mm)	60.325 +0.089/+0.127	44.450 +/-0.190	BP0508-0603-0445-BSHH
50.800 (2.000") +0.038/+0.076 (mm)	60.325 +0.064/+0.102	44.450	BP0508-0603-0445-BSTH
50.800 (2.000") +0.063/+0.102 (mm)	60.325 +0.076/+0.127	50.800 +/-0.190	BP0508-0603-0508-BSHT
50.800 (2.000") +0.038/+0.076 (mm)	60.325 +0.064/+0.102	50.800	BP0508-0603-0508-BSTH
50.800 (2.000") +0.064/+0.102 (mm)	60.325 +0.089/+0.127	63.500 +/-0.190	BP0508-0603-0635-BSHH
50.800 (2.000") +0.038/+0.076 (mm)	60.325 +0.064/+0.102	63.500	BP0508-0603-0635-BSTH
50.800 (2.000") +0.064/+0.102 (mm)	60.325 +0.089/+0.127	69.850 +/-0.190	BP0508-0603-0699-BSHH
50.800 (2.000") +0.038/+0.076 (mm)	60.325 +0.064/+0.102	76.200	BP0508-0603-0762-BSTH
50.800 (2.000") +0.064/+0.102 (mm)	60.325 +0.089/+0.127	76.200 +/-0.190	BP0508-0603-0762-BSHH
50.800 (2.000") +0.064/+0.102 (mm)	60.325 +0.089/+0.127	88.900 +/-0.254	BP0508-0603-0889-BSHH
50.800 (2.000") +0.038/+0.076 (mm)	60.325 +0.064/+0.102	88.900	BP0508-0603-0889-BSTH
50.800 (2.000") +0.064/+0.102 (mm)	60.325 +0.089/+0.127	101.600 +/-0.254	BP0508-0603-1016-BSHH
50.800 (2.000") +0.038/+0.076 (mm)	60.325 +0.064/+0.102	101.600	BP0508-0603-1016-BSTH
50.800 (2.000") +0.064/+0.102 (mm)	63.500 +0.089/+0.127	25.400 +/-0.127	BP0508-0635-0254-BSHH
50.800 (2.000") +0.038/+0.076 (mm)	63.500 +0.038/+0.076	38.100	BP0508-0635-0381-BSTH
50.800 (2.000") +0.064/+0.102 (mm)	63.500 +0.089/+0.127	38.100 +/-0.127	BP0508-0635-0381-BSHH
50.800 (2.000") +0.038/+0.076 (mm)	63.500 +0.038/+0.076	50.800	BP0508-0635-0508-BSTH
50.800 (2.000") +0.064/+0.102 (mm)	63.500 +0.089/+0.127	50.800 +/-0.190	BP0508-0635-0508-BSHH
50.800 (2.000") +0.064/+0.102 (mm)	63.500 +0.089/+0.127	63.500 +/-0.190	BP0508-0635-0635-BSHH
50.800 (2.000") +0.038/+0.076 (mm)	63.500 +0.038/+0.076	63.500	BP0508-0635-0635-BSTH
50.800 (2.000") +0.038/+0.076 (mm)	63.500 +0.038/+0.076	76.200	BP0508-0635-0762-BSTH
50.800 (2.000") +0.064/+0.102 (mm)	63.500 +0.089/+0.127	76.200 +/-0.190	BP0508-0635-0762-BSHH
50.800 (2.000") +0.064/+0.102 (mm)	63.500 +0.089/+0.127	88.900 +/-0.254	BP0508-0635-0889-BSHH
50.800 (2.000") +0.064/+0.102 (mm)	63.500 +0.089/+0.127	101.600 +/-0.254	BP0508-0635-1016-BSHH
55.563 (2.188") +0.038/+0.063 (mm)	60.325 +0.076/+0.102	38.100 +/-0.127	BP0556-0603-0381-BSTH
57.150 (2.250") +0.076/+0.102 (mm)	66.675 +0.089/+0.127	50.800 +/-0.190	BP0572-0667-0508-BSHH
57.150 (2.250") +0.064/+0.102 (mm)	66.675 +0.076/+0.127	63.500 +/-0.190	BP0572-0667-0635-BSHH

 Stocked or Short Delivery

 Usually Available Short Delivery

 Long delivery or not in current production

* Large Minimum Quantities

** Available only while stock last:

Bushes - Plain

Nominal ID (d) mm (inches)	Nominal OD (D) mm	Length (S) mm	Part Number
57.150 (2.250") +0.064/+0.102 (mm)	66.675 +0.076/+0.114	76.200 +/-0.190	BP0572-0667-0762-BSHH
57.150 (2.250") +0.064/+0.102 (mm)	66.675 +0.076/+0.114	76.200 +/-0.190	BP0572-0667-0762-BSHH2
57.150 (2.250") +0.076/+0.102 (mm)	66.675 +0.089/+0.114	88.900 +/-0.254	BP0572-0667-0889-BSHH
57.150 (2.250") +0.076/+0.102 (mm)	66.675 +0.089/+0.114	114.300 +/-0.254	BP0572-0667-1143-BSHH
57.150 (2.250") +0.051/+0.076 (mm)	69.850 +0.051/+0.076	38.100 +/-0.127	BP0572-0699-0381-BS
57.150 (2.250") +0.064/+0.102 (mm)	69.850 +0.076/+0.127	50.800 +/-0.190	BP0572-0699-0508-BSHH
57.150 (2.250") +0.038/+0.076 (mm)	69.850 +0.025/+0.076	50.800 +/-0.190	BP0572-0699-0508-BSTL
57.150 (2.250") +0.038/+0.076 (mm)	69.850 +0.025/+0.076	76.200 +/-0.190	BP0572-0699-0762-BSTL
57.150 (2.250") +0.064/+0.102 (mm)	69.850 +0.076/+0.127	76.200 +/-0.190	BP0572-0699-0762-BSHH
60.000 (2.362") +0.051/+0.076 (mm)	68.000 +0.059/+0.105	50.000 +/-0.190	BP0600-0680-0500-BS
60.000 (2.362") +0.051/+0.076 (mm)	68.000 +0.059/+0.105	60.000 +/-0.190	BP0600-0680-0600-BS
60.000 (2.362") +0.051/+0.076 (mm)	72.000 +0.059/+0.105	50.000 +/-0.190	BP0600-0720-0500-BS
60.000 (2.362") +0.051/+0.076 (mm)	72.000 +0.059/+0.105	60.000 +/-0.190	BP0600-0720-0600-BS
60.000 (2.362") +0.051/+0.076 (mm)	72.000 +0.059/+0.105	70.000 +/-0.190	BP0600-0720-0700-BS
60.325 (2.375") +0.025/+0.051 (mm)	66.675 +0.089/+0.114	31.750 +/-0.127	BP0603-0667-0318-BSLH
60.325 (2.375") +0.025/+0.051 (mm)	66.675 +0.089/+0.114	41.275 +/-0.190	BP0603-0667-0413-BSLH
60.325 (2.375") +0.064/+0.102 (mm)	69.850 +0.076/+0.127	50.800 +/-0.190	BP0603-0699-0508-BSHH
60.325 (2.375") +0.064/+0.102 (mm)	69.850 +0.025/+0.076	50.800	BP0603-0699-0508-BSHL
60.325 (2.375") +0.064/+0.102 (mm)	69.850 +0.076/+0.127	63.500 +/-0.190	BP0603-0699-0635-BSHH
60.325 (2.375") +0.064/+0.102 (mm)	69.850 +0.025/+0.076	63.500	BP0603-0699-0635-BSHL
60.325 (2.375") +0.064/+0.102 (mm)	69.850 +0.076/+0.127	76.200 +/-0.190	BP0603-0699-0762-BSHH
60.325 (2.375") +0.064/+0.102 (mm)	69.850 +0.025/+0.076	76.200	BP0603-0699-0762-BSHL
63.500 (2.500") +0.089/+0.127 (mm)	69.850 +0.051/+0.102	50.800	BP0635-0699-0508-BSHT
63.500 (2.500") +0.064/+0.102 (mm)	69.850 +0.076/+0.127	50.800 +/-0.190	BP0635-0699-0508-BSHH
63.500 (2.500") +0.064/+0.102 (mm)	69.850 +0.076/+0.127	63.500 +/-0.190	BP0635-0699-0635-BSHH
63.500 (2.500") +0.089/+0.127 (mm)	69.850 +0.051/+0.102	63.500	BP0635-0699-0635-BSHT
63.500 (2.500") +0.064/+0.102 (mm)	69.850 +0.076/+0.127	76.200 +/-0.190	BP0635-0699-0762-BSHH
63.500 (2.500") +0.089/+0.127 (mm)	69.850 +0.051/+0.102	76.200	BP0635-0699-0762-BSHT
63.500 (2.500") +0.064/+0.102 (mm)	69.850 +0.076/+0.127	101.600 +/-0.254	BP0635-0699-1016-BSHH
63.500 (2.500") +0.076/+0.102 (mm)	73.025 +0.089/+0.127	57.150 +/-0.190	BP0635-0730-0572-BSHH
63.500 (2.500") +0.076/+0.102 (mm)	73.025 +0.089/+0.127	63.500 +/-0.190	BP0635-0730-0635-BSHH
63.500 (2.500") +0.076/+0.102 (mm)	73.025 +0.089/+0.127	76.200 +/-0.190	BP0635-0730-0762-BSHH
63.500 (2.500") +0.076/+0.102 (mm)	76.200 +0.089/+0.127	50.800 +/-0.190	BP0635-0762-0508-BSHH
63.500 (2.500") +0.076/+0.102 (mm)	76.200 +0.102/+0.127	63.500 +/-0.190	BP0635-0762-0635-BSHH

Stocked or Short Delivery

Usually Available Short Delivery

Long delivery or not in current production

* Large Minimum Quantities

** Available only while stock last:

Bushes - Plain

Nominal ID (d) mm (inches)	Nominal OD (D) mm	Length (S) mm	Part Number
63.500 (2.500") +0.076/+0.102 (mm)	76.200 +0.089/+0.127	76.200 +/-0.190	BP0635-0762-0762-BSHH
63.500 (2.500") +0.076/+0.102 (mm)	76.200 +0.089/+0.127	101.600 +/-0.254	BP0635-0762-1016-BSHH
69.850 (2.750") +0.051/+0.102 (mm)	76.200 +0.076/+0.127	38.100 +/-0.127	BP0699-0762-0381-BSTH
69.850 (2.750") +0.051/+0.102 (mm)	76.200 +0.076/+0.127	63.500 +/-0.190	BP0699-0762-0635-BSTH
69.850 (2.750") +0.051/+0.076 (mm)	79.375 +0.076/+0.102	31.750 +/-0.127	BP0699-0794-0318-BS
69.850 (2.750") +0.051/+0.076 (mm)	79.375 +0.076/+0.102	69.850 +/-0.190	BP0699-0794-0699-BS
69.850 (2.750") +0.051/+0.076 (mm)	79.375 +0.076/+0.102	101.600 +/-0.254	BP0699-0794-1016-BS
69.850 (2.750") +0.025/+0.051 (mm)	82.550 +0.076/+0.102	38.100 +/-0.127	BP0699-0826-0381-BSLT
69.850 (2.750") +0.000/+0.051 (mm)	82.550 +0.051/+0.102	50.800	BP0699-0826-0508-BSLT
69.850 (2.750") +0.051/+0.102 (mm)	82.550 +0.076/+0.127	50.800 +/-0.190	BP0699-0826-0508-BSTH
69.850 (2.750") +0.000/+0.051 (mm)	82.550 +0.051/+0.102	76.200	BP0699-0826-0762-BSLT
69.850 (2.750") +0.051/+0.102 (mm)	82.550 +0.076/+0.127	76.200 +/-0.190	BP0699-0826-0762-BSTH
69.850 (2.750") +0.025/+0.051 (mm)	82.550 +0.076/+0.102	101.600 +/-0.254	BP0699-0826-1016-BSLT
69.850 (2.750") +0.051/+0.102 (mm)	82.550 +0.076/+0.127	101.600 +/-0.254	BP0699-0826-1016-BSTH
74.613 (2.938") +0.038/+0.063 (mm)	84.138 +0.038/+0.063	76.200 +/-0.190	BP0746-0841-0762-BSLL
76.200 (3.000") +0.025/+0.051 (mm)	82.550 +0.102/+0.127	31.750 +/-0.127	BP0762-0826-0318-BSLH
76.200 (3.000") +0.076/+0.127 (mm)	82.550 +0.076/+0.127	50.800 +/-0.190	BP0762-0826-0508-BSHH
76.200 (3.000") +0.000/+0.051 (mm)	82.550 -0.038/+0.013	50.800	BP0762-0826-0508-BSLU
76.200 (3.000") +0.076/+0.127 (mm)	82.550 +0.076/+0.127	76.200 +/-0.190	BP0762-0826-0762-BSHH
76.200 (3.000") +0.000/+0.051 (mm)	82.550 -0.038/+0.013	76.200	BP0762-0826-0762-BSLU
76.200 (3.000") +0.076/+0.127 (mm)	88.900 +0.076/+0.127	50.800 +/-0.190	BP0762-0889-0508-BSHH
76.200 (3.000") +0.076/+0.127 (mm)	88.900 +0.076/+0.127	63.500 +/-0.190	BP0762-0889-0635-BSHH
76.200 (3.000") +0.051/+0.102 (mm)	88.900 +0.076/+0.127	63.500	BP0762-0889-0635-BSTH
76.200 (3.000") +0.051/+0.102 (mm)	88.900 +0.076/+0.127	76.200	BP0762-0889-0762-BSTH
76.200 (3.000") +0.076/+0.127 (mm)	88.900 +0.076/+0.127	76.200 +/-0.190	BP0762-0889-0762-BSHH
76.200 (3.000") +0.076/+0.127 (mm)	88.900 +0.076/+0.127	101.600 +/-0.254	BP0762-0889-1016-BSHH
76.200 (3.000") +0.051/+0.102 (mm)	88.900 +0.076/+0.127	101.600	BP0762-0889-1016-BSTH
82.550 (3.250") +0.051/+0.076 (mm)	92.075 +0.051/+0.076	101.600 +/-0.254	BP0826-0921-1016-BSTL
88.900 (3.500") +0.063/+0.088 (mm)	101.600 +0.076/+0.102	50.800 +/-0.190	BP0889-1016-0508-BS
88.900 (3.500") +0.038/+0.089 (mm)	101.600 +0.038/+0.102	76.200	BP0889-1016-0762-BSLL
88.900 (3.500") +0.076/+0.127 (mm)	101.600 +0.089/+0.152	76.200 +/-0.190	BP0889-1016-0762-BSHH
88.900 (3.500") +0.076/+0.127 (mm)	101.600 +0.089/+0.152	88.900 +/-0.254	BP0889-1016-0889-BSHH
88.900 (3.500") +0.038/+0.089 (mm)	101.600 +0.038/+0.102	88.900	BP0889-1016-0889-BSLL
88.900 (3.500") +0.076/+0.127 (mm)	101.600 +0.089/+0.152	101.600 +/-0.254	BP0889-1016-1016-BSHH

 Stocked or Short Delivery

 Usually Available Short Delivery

 Long delivery or not in current production

* Large Minimum Quantities

** Available only while stock last:

Bushes - Plain

Nominal ID (d) mm (inches)	Nominal OD (D) mm	Length (S) mm	Part Number
88.900 (3.500") +0.038/+0.089 (mm)	101.600 +0.038/+0.102	101.600	BP0889-1016-1016-BSLL
101.600 (4.000") +0.025/+0.089 (mm)	114.300 +0.038/+0.102	101.600	BP1016-1143-1016-BSLL
101.600 (4.000") +0.063/+0.088 (mm)	114.300 +0.076/+0.102	152.400 +/-0.381	BP1016-1143-1524-BS
101.600 (4.000") +0.051/+0.076 (mm)	117.475 +0.051/+0.076	101.600 +/-0.254	BP1016-1175-1016-BSLL
114.300 (4.500") +0.076/+0.102 (mm)	133.350 +0.089/+0.114	127.000 +/-0.381	BP1143-1334-1270-BS
127.000 (5.000") +0.076/+0.102 (mm)	146.050 +0.102/+0.127	50.800 +/-0.190	BP1270-1461-0508-BSLT

Bushes - Spherical OD

Nominal ID (d) mm (inches)	Nominal OD (D) mm	Length (S) mm	Part Number
4.000 (0.157")	9.500	8.000	* BSP00400-00950-0080-SB
5.000 (0.197")	12.500	10.000	** BSP00500-01250-0100-SB
6.000 (0.236")	14.500	11.000	** BSP00600-01450-0110-SB
7.000 (0.276")	15.500	11.000	** BSP00700-01550-0110-SB
8.000 (0.315")	15.500	11.000	** BSP00800-01550-0110-SB
10.000 (0.394")	21.000	14.000	* BSP01000-02100-0140-SB
12.000 (0.472")	24.000	16.000	* BSP01200-02400-0160-SB

Rod

Nom. Dia (D) mm (inches)	Length (L) mm	Grade	Part Number
6.35 (0.250") +0.15/+3.20 (mm)	31.8	SAE 841	* 0R-0064-0032-SB
6.35 (0.250") +0.15/+3.20 (mm)	50.8	SAE 841	0R-0064-0051-SB
9.53 (0.375") +0.15/+3.20 (mm)	38.0	SAE 841	* 0R-0095-0038-SB
9.53 (0.375") +0.15/+3.20 (mm)	76.2	SAE 841	0R-0095-0076-SB
12.70 (0.500") +0.15/+3.20 (mm)	38.8	SAE 841	* 0R-0127-0039-SB
12.70 (0.500") +0.15/+3.20 (mm)	165.1	SAE 841	0R-0127-0165-SB
15.88 (0.625") +0.15/+3.20 (mm)	51.0	SAE 841	* 0R-0159-0051-SB
15.88 (0.625") +0.15/+3.20 (mm)	165.1	SAE 841	0R-0159-0165-SB
19.05 (0.750") +0.15/+3.20 (mm)	51.0	SAE 841	* 0R-0191-0051-SB
19.05 (0.750") +0.15/+3.20 (mm)	165.1	SAE 841	0R-0191-0165-SB
22.23 (0.875") +0.15/+3.20 (mm)	51.0	SAE 841	* 0R-0222-0051-SB
22.23 (0.875") +0.15/+3.20 (mm)	165.1	SAE 841	0R-0222-0165-SB
25.40 (1.000") +0.15/+3.20 (mm)	63.5	SAE 841	* 0R-0254-0064-SB
25.40 (1.000") +0.15/+3.20 (mm)	165.1	SAE 841	0R-0254-0165-SB
28.58 (1.125") +0.15/+3.20 (mm)	108.0	SAE 841	* 0R-0286-0108-SB
28.58 (1.125") +0.15/+3.20 (mm)	165.1	SAE 841	0R-0286-0165-SB
31.75 (1.250") +0.15/+3.20 (mm)	63.5	SAE 841	* 0R-0318-0064-SB
31.75 (1.250") +0.15/+3.20 (mm)	165.1	SAE 841	0R-0318-0165-SB
34.93 (1.375") +0.15/+3.20 (mm)	69.9	SAE 841	* 0R-0349-0070-SB
34.93 (1.375") +0.15/+3.20 (mm)	165.1	SAE 841	0R-0349-0165-SB

Stocked or Short Delivery

Usually Available Short Delivery

Long delivery or not in current production

* Large Minimum Quantities

** Available only while stock last:

Page 73 of 82

E&OE

Rod			
Nom. Dia (D) mm (inches)	Length (L) mm	Grade	Part Number
38.10 (1.500") +0.15/+3.20 (mm)	165.1	SAE 841	0R-0381-0165-SB
41.28 (1.625") +0.15/+3.20 (mm)	69.9	SAE 841	* 0R-0413-0070-SB
41.28 (1.625") +0.15/+3.20 (mm)	165.1	SAE 841	0R-0413-0165-SB
44.45 (1.750") +0.15/+3.20 (mm)	165.1	SAE 841	0R-0445-0165-SB
50.80 (2.000") +0.15/+3.20 (mm)	165.1	SAE 841	0R-0508-0165-SB
57.15 (2.250") +0.15/+3.20 (mm)	165.1	SAE 841	0R-0572-0165-SB
63.50 (2.500") +0.15/+3.20 (mm)	165.1	SAE 841	0R-0635-0165-SB
69.85 (2.750") +0.15/+3.20 (mm)	165.1	SAE 841	* 0R-0699-0165-SB
76.20 (3.000") +0.15/+3.20 (mm)	165.1	SAE 841	0R-0762-0165-SB
82.55 (3.250") +0.15/+3.20 (mm)	165.1	SAE 841	* 0R-0826-0165-SB
88.90 (3.500") +0.15/+3.20 (mm)	165.1	SAE 841	* 0R-0889-0165-SB
101.60 (4.000") +0.15/+3.20 (mm)	165.1	SAE 841	0R-1016-0165-SB
114.30 (4.500") +0.15/+3.20 (mm)	165.1	SAE 841	* 0R-1143-0165-SB
127.00 (5.000") +0.15/+3.20 (mm)	165.1	SAE 841	* 0R-1270-0165-SB
139.70 (5.500") +0.15/+3.20 (mm)	152.4	SAE 841	* 0R-1397-0152-SB
152.40 (6.000") +0.15/+3.20 (mm)	152.4	SAE 841	* 0R-1524-0152-SB
203.20 (8.000") +0.15/+3.20 (mm)	165.1	SAE 841	0R-2032-0165-SB

Sheet			
Thickness mm (inches)	Width mm	Length mm	Part Number
3.18 (0.125")	25.4	108.0	** SHT-0318-0025-0108-SB
3.18 (0.125")	127.00	152.40	SHT-0318-0127-0152-SB
3.18 (0.125")	152.40	304.80	SHT-0318-0152-0305-SB
4.76 (0.187")	152.40	304.80	SHT-0476-0152-0305-SB
6.35 (0.250")	50.80	206.38	SHT-0635-0051-0206-SB
6.35 (0.250")	127.00	203.20	SHT-0635-0127-0203-SB
6.35 (0.250")	152.4	305.0	SHT-0635-0152-0305-SB
6.35 (0.250")	254.0	254.0	SHT-0635-0254-0254-SB
12.70 (0.500")	50.80	206.38	* SHT-1270-0051-0206-SB
19.05 (0.750")	127.00	203.20	SHT-1905-0127-0203-SB
19.05 (0.750")	152.40	304.80	SHT-1905-0152-0305-SB

Tube				
Nom. OD mm (inches)	Nom. ID mm	Length (L) mm	Info	Part Number
25.40 (1.000") +0.80/+3.20 (mm)	12.70 -0.80/-3.20	165.1		0T-0254-0127-0165-SB
25.40 (1.000") +0.80/+3.20 (mm)	15.88 -0.80/-3.20	165.1		0T-0254-0159-0165-SB
28.58 (1.125") +0.80/+3.20 (mm)	12.70 -0.80/-3.20	165.1		0T-0286-0127-0165-SB
28.58 (1.125") +0.80/+3.20 (mm)	15.88 -0.80/-3.20	165.1		0T-0286-0159-0165-SB
31.75 (1.250") +0.80/+3.20 (mm)	12.70 -0.80/-3.20	165.1		0T-0318-0127-0165-SB
31.75 (1.250") +0.80/+3.20 (mm)	15.88 -0.80/-3.20	165.1		0T-0318-0159-0165-SB
31.75 (1.250") +0.80/+3.20 (mm)	19.05 -0.80/-3.20	165.1		0T-0318-0191-0165-SB

Stocked or Short Delivery

Usually Available Short Delivery

Long delivery or not in current production

* Large Minimum Quantities

** Available only while stock last:

Tube				
Nom. OD mm (inches)	Nom. ID mm	Length (L) mm	Info	Part Number
34.93 (1.375")	15.88	165.1		0T-0349-0159-0165-SB
+0.80/+3.20 (mm)	-0.80/-3.20			
34.93 (1.375")	22.23	165.1		0T-0349-0222-0165-SB
+0.80/+3.20 (mm)	-0.80/-3.20			
38.10 (1.500")	12.70	165.1		0T-0381-0127-0165-SB
+0.80/+3.20 (mm)	-0.80/-3.20			
38.10 (1.500")	15.88	165.1		0T-0381-0159-0165-SB
+0.80/+3.20 (mm)	-0.80/-3.20			
38.10 (1.500")	19.05	165.1		0T-0381-0191-0165-SB
+0.80/+3.20 (mm)	-0.80/-3.20			
38.10 (1.500")	22.23	165.1		0T-0381-0222-0165-SB
+0.80/+3.20 (mm)	-0.80/-3.20			
38.10 (1.500")	25.40	165.1		0T-0381-0254-0165-SB
+0.80/+3.20 (mm)	-0.80/-3.20			
41.28 (1.625")	25.40	165.1		0T-0413-0254-0165-SB
+0.80/+3.20 (mm)	-0.80/-3.20			
44.45 (1.750")	15.88	165.1		0T-0445-0159-0165-SB
+0.80/+3.20 (mm)	-0.80/-3.20			
44.45 (1.750")	19.05	165.1		0T-0445-0191-0165-SB
+0.80/+3.20 (mm)	-0.80/-3.20			
44.45 (1.750")	25.40	165.1		0T-0445-0254-0165-SB
+0.80/+3.20 (mm)	-0.80/-3.20			
44.45 (1.750")	31.75	165.1		0T-0445-0318-0165-SB
+0.80/+3.20 (mm)	-0.80/-3.20			
50.80 (2.000")	12.70	165.1		0T-0508-0127-0165-SB
+0.80/+3.20 (mm)	-0.80/-3.20			
50.80 (2.000")	15.88	165.1		0T-0508-0159-0165-SB
+0.80/+3.20 (mm)	-0.80/-3.20			
50.80 (2.000")	19.05	165.1		0T-0508-0191-0165-SB
+0.80/+3.20 (mm)	-0.80/-3.20			
50.80 (2.000")	22.23	165.1		0T-0508-0222-0165-SB
+0.80/+3.20 (mm)	-0.80/-3.20			
50.80 (2.000")	25.40	165.1		0T-0508-0254-0165-SB
+0.80/+3.20 (mm)	-0.80/-3.20			
50.80 (2.000")	31.75	165.1		0T-0508-0318-0165-SB
+0.80/+3.20 (mm)	-0.80/-3.20			
50.80 (2.000")	34.93	165.1		0T-0508-0349-0165-SB
+0.80/+3.20 (mm)	-0.80/-3.20			
50.80 (2.000")	38.10	165.1		0T-0508-0381-0165-SB
+0.80/+3.20 (mm)	-0.80/-3.20			
53.98 (2.125")	28.58	165.1		0T-0540-0286-0165-SB
+0.80/+3.20 (mm)	-0.80/-3.20			
57.15 (2.250")	19.05	165.1		0T-0572-0191-0165-SB
+0.80/+3.20 (mm)	-0.80/-3.20			
57.15 (2.250")	22.23	165.1		0T-0572-0222-0165-SB
+0.80/+3.20 (mm)	-0.80/-3.20			
57.15 (2.250")	25.40	165.1		0T-0572-0254-0165-SB
+0.80/+3.20 (mm)	-0.80/-3.20			
57.15 (2.250")	31.75	165.1		0T-0572-0318-0165-SB
+0.80/+3.20 (mm)	-0.80/-3.20			
57.15 (2.250")	38.10	165.1		0T-0572-0381-0165-SB
+0.80/+3.20 (mm)	-0.80/-3.20			
57.15 (2.250")	44.45	165.1		0T-0572-0445-0165-SB
+0.80/+3.20 (mm)	-0.80/-3.20			
63.50 (2.500")	19.05	165.1		0T-0635-0191-0165-SB
+0.80/+3.20 (mm)	-0.80/-3.20			
63.50 (2.500")	25.40	165.1		0T-0635-0254-0165-SB
+0.80/+3.20 (mm)	-0.80/-3.20			
63.50 (2.500")	31.75	165.1		0T-0635-0318-0165-SB
+0.80/+3.20 (mm)	-0.80/-3.20			
63.50 (2.500")	38.10	165.1		0T-0635-0381-0165-SB
+0.80/+3.20 (mm)	-0.80/-3.20			
63.50 (2.500")	44.45	165.1		0T-0635-0445-0165-SB
+0.80/+3.20 (mm)	-0.80/-3.20			
66.68 (2.625")	44.45	165.1		0T-0667-0445-0165-SB
+0.80/+3.20 (mm)	-0.80/-3.20			
69.85 (2.750")	19.05	165.1		0T-0699-0191-0165-SB
+0.80/+3.20 (mm)	-0.80/-3.20			

Tube				
Nom. OD mm (inches)	Nom. ID mm	Length (L) mm	Info	Part Number
69.85 (2.750")	34.93	165.1		0T-0699-0349-0165-SB
+0.80/+3.20 (mm)	-0.80/-3.20			
69.85 (2.750")	38.10	165.1		0T-0699-0381-0165-SB
+0.80/+3.20 (mm)	-0.80/-3.20			
69.85 (2.750")	44.45	165.1		0T-0699-0445-0165-SB
+0.80/+3.20 (mm)	-0.80/-3.20			
69.85 (2.750")	50.80	165.1		0T-0699-0508-0165-SB
+0.80/+3.20 (mm)	-0.80/-3.20			
76.20 (3.000")	25.40	165.1		0T-0762-0254-0165-SB
+0.80/+3.20 (mm)	-0.80/-3.20			
76.20 (3.000")	31.75	165.1		0T-0762-0318-0165-SB
+0.80/+3.20 (mm)	-0.80/-3.20			
76.20 (3.000")	38.10	165.1		0T-0762-0381-0165-SB
+0.80/+3.20 (mm)	-0.80/-3.20			
76.20 (3.000")	44.45	165.1		0T-0762-0445-0165-SB
+0.80/+3.20 (mm)	-0.80/-3.20			
76.20 (3.000")	50.80	165.1		0T-0762-0508-0165-SB
+0.80/+3.20 (mm)	-0.80/-3.20			
76.20 (3.000")	57.15	165.1		0T-0762-0572-0165-SB
+0.80/+3.20 (mm)	-0.80/-3.20			
76.20 (3.000")	60.33	165.1		0T-0762-0603-0165-SB
+0.80/+3.20 (mm)	-0.80/-3.20			
82.55 (3.250")	50.80	165.1		0T-0826-0508-0165-SB
+0.80/+3.20 (mm)	-0.80/-3.20			
82.55 (3.250")	57.15	165.1		0T-0826-0572-0165-SB
+0.80/+3.20 (mm)	-0.80/-3.20			
88.90 (3.500")	25.40	165.1		0T-0889-0254-0165-SB
+0.80/+3.20 (mm)	-0.80/-3.20			
88.90 (3.500")	31.75	165.1		0T-0889-0318-0165-SB
+0.80/+3.20 (mm)	-0.80/-3.20			
88.90 (3.500")	38.10	165.1		0T-0889-0381-0165-SB
+0.80/+3.20 (mm)	-0.80/-3.20			
88.90 (3.500")	44.45	165.1		0T-0889-0445-0165-SB
+0.80/+3.20 (mm)	-0.80/-3.20			
88.90 (3.500")	57.15	165.1		0T-0889-0572-0165-SB
+0.80/+3.20 (mm)	-0.80/-3.20			
88.90 (3.500")	60.33	165.1		0T-0889-0603-0165-SB
+0.80/+3.20 (mm)	-0.80/-3.20			
88.90 (3.500")	63.50	165.1		0T-0889-0635-0165-SB
+0.80/+3.20 (mm)	-0.80/-3.20			
95.25 (3.750")	57.15	165.1		0T-0953-0572-0165-SB
+0.80/+3.20 (mm)	-0.80/-3.20			
95.25 (3.750")	63.50	165.1		0T-0953-0635-0165-SB
+0.80/+3.20 (mm)	-0.80/-3.20			
95.25 (3.750")	69.85	165.1		0T-0953-0699-0165-SB
+0.80/+3.20 (mm)	-0.80/-3.20			
95.25 (3.750")	76.20	165.1		0T-0953-0762-0165-SB
+0.80/+3.20 (mm)	-0.80/-3.20			
101.60 (4.000")	25.40	165.1		0T-1016-0254-0165-SB
+0.80/+3.20 (mm)	-0.80/-3.20			
101.60 (4.000")	31.75	165.1		0T-1016-0318-0165-SB
+0.80/+3.20 (mm)	-0.80/-3.20			
101.60 (4.000")	38.10	165.1		0T-1016-0381-0165-SB
+0.80/+3.20 (mm)	-0.80/-3.20			
101.60 (4.000")	50.80	165.1		0T-1016-0508-0165-SB
+0.80/+3.20 (mm)	-0.80/-3.20			
101.60 (4.000")	57.15	165.1		0T-1016-0572-0165-SB
+0.80/+3.20 (mm)	-0.80/-3.20			
101.60 (4.000")	60.33	165.1		0T-1016-0603-0165-SB
+0.80/+3.20 (mm)	-0.80/-3.20			
101.60 (4.000")	63.50	165.1		0T-1016-0635-0165-SB
+0.80/+3.20 (mm)	-0.80/-3.20			
101.60 (4.000")	76.20	165.1		0T-1016-0762-0165-SB
+0.80/+3.20 (mm)	-0.80/-3.20			
107.95 (4.250")	44.45	165.1		0T-1080-0445-0165-SB
+0.80/+3.20 (mm)	-0.80/-3.20			
107.95 (4.250")	63.50	165.1		0T-1080-0635-0165-SB
+0.80/+3.20 (mm)	-0.80/-3.20			

 Stocked or Short Delivery

 Usually Available Short Delivery

 Long delivery or not in current production

* Large Minimum Quantities

** Available only while stock last:

Tube				
Nom. OD mm (inches)	Nom. ID mm	Length (L) mm	Info	Part Number
107.95 (4.250") +0.80/+3.20 (mm)	82.55 -0.80/-3.20	165.1		OT-1080-0826-0165-SB
114.30 (4.500") +0.80/+3.20 (mm)	44.45 -0.80/-3.20	165.1		OT-1143-0445-0165-SB
114.30 (4.500") +0.80/+3.20 (mm)	50.80 -0.80/-3.20	165.1		OT-1143-0508-0165-SB
114.30 (4.500") +0.80/+3.20 (mm)	57.15 -0.80/-3.20	165.1		OT-1143-0572-0165-SB
114.30 (4.500") +0.80/+3.20 (mm)	57.15 -0.80/-3.20	165.1	This is 4.5 inch OD with a small dent in the OD. Suitable to machine to 110mm or less	** OT-1100-0572-0165-SB
114.30 (4.500") +0.80/+3.20 (mm)	60.33 -0.80/-3.20	165.1		OT-1143-0603-0165-SB
114.30 (4.500") +0.80/+3.20 (mm)	63.50 -0.80/-3.20	165.1		OT-1143-0635-0165-SB
114.30 (4.500") +0.80/+3.20 (mm)	76.20 -0.80/-3.20	165.1		OT-1143-0762-0165-SB
120.65 (4.750") +0.80/+3.20 (mm)	88.90 -0.80/-3.20	165.1		OT-1207-0889-0165-SB
127.00 (5.000") +0.80/+3.20 (mm)	50.80 -0.80/-3.20	165.1		OT-1270-0508-0165-SB
127.00 (5.000") +0.80/+3.20 (mm)	63.50 -0.80/-3.20	165.1		OT-1270-0635-0165-SB
127.00 (5.000") +0.80/+3.20 (mm)	76.20 -0.80/-3.20	165.1		OT-1270-0762-0165-SB
127.00 (5.000") +0.80/+3.20 (mm)	88.90 -0.80/-3.20	165.1		OT-1270-0889-0165-SB
127.00 (5.000") +0.80/+3.20 (mm)	95.25 -0.80/-3.20	165.1		OT-1270-0953-0165-SB
139.70 (5.500") +0.80/+3.20 (mm)	50.80 -0.80/-3.20	165.1		OT-1397-0508-0165-SB
139.70 (5.500") +0.80/+3.20 (mm)	101.60 -0.80/-3.20	165.1		OT-1397-1016-0165-SB
150.00 (5.906") +0.80/+3.20 (mm)	76.20 -0.80/-3.20	165.1	This is 6 inch OD with a small dent in the OD. Suitable to machine to 150mm or less	** OT-1500-0762-0165-SB
152.40 (6.000") +0.80/+3.20 (mm)	76.20 -0.80/-3.20	165.1		OT-1524-0762-0165-SB
152.40 (6.000") +0.80/+3.20 (mm)	88.90 -0.80/-3.20	165.1		OT-1524-0889-0165-SB
152.40 (6.000") +0.80/+3.20 (mm)	101.60 -0.80/-3.20	165.1		OT-1524-1016-0165-SB
152.40 (6.000") +0.80/+3.20 (mm)	114.30 -0.80/-3.20	165.1		OT-1524-1143-0165-SB
177.80 (7.000") +0.80/+3.20 (mm)	101.60 -0.80/-3.20	165.1		OT-1778-1016-0165-SB
177.80 (7.000") +0.80/+3.20 (mm)	127.00 -0.80/-3.20	165.1		OT-1778-1270-0165-SB
203.20 (8.000") +0.80/+3.20 (mm)	152.40 -0.80/-3.20	165.1		OT-2032-1524-0165-SB
228.60 (9.000") +0.80/+3.20 (mm)	177.80 -0.80/-3.20	165.1		OT-2286-1778-0165-SB

Washers				
Nom. ID (d) mm (inches)	OD (D) mm	Thickness (T) mm	Other	Part Number
3.000 (0.118") +0.007/+0.330 (mm)	9.50 +/-0.25	1.60 +/-0.07	Thrust Washer	W0030-F-010-016-SB
3.175 (0.125") +0.12/+0.25 (mm)	9.40 +/-0.254	1.58 +/-0.064	Thrust Washer	W0032-F-009-016-SB
4.000 (0.157") +0.017/+0.430 (mm)	9.50 +/-0.25	1.60 +/-0.07	Thrust Washer	W0040-F-010-016-SB
4.762 (0.187") +0.12/+0.25 (mm)	12.57 +/-0.254	1.58 +/-0.064	Thrust Washer	W0048-F-013-016-SB

Stocked or Short Delivery

Usually Available Short Delivery

Long delivery or not in current production

* Large Minimum Quantities

** Available only while stock last:

Page 77 of 82

E&OE

Washers

Nom. ID (d) mm (inches)	OD (D) mm	Thickness (T) mm	Other	Part Number
5.000 (0.197") +0.017/+0.430 (mm)	12.50 +/-0.25	1.60 +/-0.07	Thrust Washer	W0050-F-013-016-SB
6.000 (0.236") +0.027/+0.530 (mm)	12.50 +/-0.25	1.60 +/-0.07	Thrust Washer	W0060-F-013-016-SB
6.000 (0.236") +0.027/+0.530 (mm)	15.88 +/-0.25	1.59 +/-0.07	Thrust Washer	* W0060-F-016-016-SB
6.350 (0.250") +0.12/+0.25 (mm)	11.11 +0.25/+0.51	1.59 +/-0.07	Thrust Washer	W0064-F-011-016-SB
6.350 (0.250") +0.12/+0.25 (mm)	12.70 +/-0.25	1.59 +/-0.07	Thrust Washer	W0064-F-013-016-SB
6.350 (0.250") +0.12/+0.25 (mm)	15.88 +/-0.25	1.59 +/-0.07	Thrust Washer	W0064-F-016-016-SB
7.938 (0.313") +0.00/+0.10 (mm)	15.88 +/-0.25	1.59 +/-0.07	Thrust Washer	W0079-F-016-016-SB
7.938 (0.313") +0.00/+0.10 (mm)	19.05 +/-0.25	1.59 +/-0.07	Thrust Washer	W0079-F-019-016-SB
8.000 (0.315") +0.027/+0.530 (mm)	19.00 +/-0.25	1.60 +/-0.07	Thrust Washer	W0080-F-019-016-SB
9.525 (0.375") +0.12/+0.25 (mm)	15.88 +/-0.25	1.59 +/-0.07	Thrust Washer	W0095-F-016-016-SB
9.525 (0.375") +0.25/+0.38 (mm)	19.05 +/-0.25	0.79 +/-0.07	Thrust Washer	W0095-F-019-008-SB
9.525 (0.375") +0.00/+0.10 (mm)	19.05 +/-0.25	1.59 +/-0.07	Thrust Washer	W0095-F-019-016-SB
9.525 (0.375") +0.00/+0.10 (mm)	19.05 +/-0.25	3.18 +/-0.07	Thrust Washer	W0095-F-019-032-SB
10.000 (0.394") +0.037/+0.630 (mm)	19.00 +/-0.25	1.60 +/-0.07	Thrust Washer	W0100-F-019-016-SB
10.000 (0.394") +0.037/+0.630 (mm)	19.00 +/-0.25	3.20 +/-0.07	Thrust Washer	W0100-F-019-032-SB
11.111 (0.437") +0.00/+0.05 (mm)	19.05 +/-0.25	1.59 +/-0.07	Thrust Washer	W0111-F-019-016-SB
11.111 (0.437") +0.00/+0.25 (mm)	19.05 +/-0.254	3.18 +/-0.064	Thrust Washer	W0111-F-019-032-SB
12.000 (0.472") +0.87/+1.13 (mm)	25.00 +/-0.25	1.60 +/-0.07	Thrust Washer	W0120-F-025-016-SB
12.000 (0.472") +0.87/+1.13 (mm)	25.00 +/-0.25	3.20 +/-0.07	Thrust Washer	W0120-F-025-032-SB
12.700 (0.500") +0.06/+0.20 (mm)	19.05 +/-0.25	1.59 +/-0.07	Thrust Washer	W0127-F-019-016-SB
12.700 (0.500") +0.06/+0.20 (mm)	22.23 +/-0.25	4.76 +/-0.07	Thrust Washer	W0127-F-022-048-SB
12.700 (0.500") +0.12/+0.25 (mm)	25.40 +/-0.25	1.58 +/-0.07	Thrust Washer	W0127-F-025-016-SB
12.700 (0.500") +0.12/+0.25 (mm)	25.40 +/-0.25	2.38 +/-0.07	Thrust Washer	W0127-F-025-024-SB
12.700 (0.500") +0.12/+0.25 (mm)	25.40 +/-0.25	3.18 +/-0.07	Thrust Washer	W0127-F-025-032-SB
14.287 (0.562") +0.12/+0.25 (mm)	31.75 +/-0.25	1.59 +/-0.07	Thrust Washer	W0143-F-032-016-SB
14.287 (0.562") +0.12/+0.25 (mm)	31.75 +/-0.25	3.18 +/-0.07	Thrust Washer	W0143-F-032-032-SB
15.875 (0.625") -0.05/+0.08 (mm)	25.40 +/-0.25	1.59 +/-0.07	Thrust Washer	W0159-F-025-016-SB
15.875 (0.625") -0.05/+0.08 (mm)	25.40 +/-0.25	3.18 +/-0.07	Thrust Washer	W0159-F-025-032-SB
15.875 (0.625") -0.05/+0.08 (mm)	30.16 +/-0.25	1.59 +/-0.07	Thrust Washer	W0159-F-030-016-SB
15.875 (0.625") -0.05/+0.08 (mm)	30.16 +/-0.25	2.38 +/-0.07	Thrust Washer	W0159-F-030-024-SB
15.875 (0.625") -0.05/+0.08 (mm)	30.16 +/-0.25	3.18 +/-0.07	Thrust Washer	W0159-F-030-032-SB
15.875 (0.625") -0.05/+0.08 (mm)	31.75 +/-0.25	1.59 +/-0.07	Thrust Washer	W0159-F-032-016-SB
15.875 (0.625") -0.05/+0.08 (mm)	31.75 +/-0.25	3.18 +/-0.07	Thrust Washer	W0159-F-032-032-SB
16.000 (0.630") +0.54/+0.65 (mm)	38.10 +/-0.25	1.59 +/-0.07	Thrust Washer	W0160-F-038-016-SB

 Stocked or Short Delivery

 Usually Available Short Delivery

 Long delivery or not in current production

* Large Minimum Quantities

** Available only while stock last:

Washers

Nom. ID (d) mm (inches)	OD (D) mm	Thickness (T) mm	Other	Part Number
16.000 (0.630") +0.54/+0.65 (mm)	38.10 +/-0.25	3.18 +/-0.07	Thrust Washer	W0160-F-038-032-SB
19.050 (0.750") -0.05/+0.08 (mm)	31.75 +/-0.25	1.59 +/-0.07	Thrust Washer	W0191-F-032-016-SB
19.050 (0.750") -0.05/+0.08 (mm)	31.75 +/-0.25	3.18 +/-0.07	Thrust Washer	W0191-F-032-032-SB
19.050 (0.750") -0.05/+0.08 (mm)	34.93 +/-0.25	1.59 +/-0.07	Thrust Washer	W0191-F-035-016-SB
19.050 (0.750") -0.05/+0.08 (mm)	34.93 +/-0.25	3.18 +/-0.07	Thrust Washer	W0191-F-035-032-SB
19.050 (0.750") -0.05/+0.08 (mm)	34.93 +/-0.25	6.35 +/-0.07	Thrust Washer	W0191-F-035-064-SB
19.050 (0.750") +0.25/+0.51 (mm)	39.69 +/-0.38	2.38 +/-0.07	Thrust Washer	W0191-F-040-024-SB
22.225 (0.875") +0.27/+0.52 (mm)	38.10 +/-0.25	1.59 +/-0.07	Thrust Washer	W0222-F-038-016-SB
22.225 (0.875") +0.27/+0.52 (mm)	38.10 +/-0.25	3.18 +/-0.07	Thrust Washer	W0222-F-038-032-SB
22.225 (0.875") +0.00/+0.25 (mm)	50.80 +/-0.38	3.18 +/-0.07	Thrust Washer	W0222-F-051-032-SB
22.225 (0.875") +0.27/+0.52 (mm)	53.98 +/-0.38	3.18 +/-0.07	Thrust Washer	W0222-F-054-032-SB
25.400 (1.000") -0.05/+0.08 (mm)	38.10 +/-0.25	1.59 +/-0.07	Thrust Washer	W0254-F-038-016-SB
25.400 (1.000") -0.05/+0.08 (mm)	38.10 +/-0.25	3.18 +/-0.07	Thrust Washer	W0254-F-038-032-SB
25.400 (1.000") -0.05/+0.08 (mm)	38.10 +/-0.25	4.76 +/-0.07	Thrust Washer	W0254-F-038-048-SB
25.400 (1.000") +0.27/+0.52 (mm)	41.28 +/-0.38	1.59 +/-0.07	Thrust Washer	W0254-F-041-016-SB
25.400 (1.000") -0.05/+0.08 (mm)	41.28 +/-0.38	3.18 +/-0.07	Thrust Washer	W0254-F-041-032-SB
25.400 (1.000") -0.05/+0.08 (mm)	41.28 +/-0.38	6.35 +/-0.07	Thrust Washer	W0254-F-041-064-SB
25.400 (1.000") -0.18/+0.43 (mm)	44.45 +/-0.38	1.59 +/-0.07	Thrust Washer	W0254-F-044-016-SB
25.400 (1.000") -0.18/+0.43 (mm)	44.45 +/-0.38	3.18 +/-0.07	Thrust Washer	W0254-F-044-032-SB
25.400 (1.000") -0.28/+0.53 (mm)	50.80 +/-0.38	3.18 +/-0.07	Thrust Washer	W0254-F-051-032-SB
25.400 (1.000") -0.28/+0.53 (mm)	50.80 +/-0.38	4.76 +/-0.07	Thrust Washer	W0254-F-051-048-SB
25.400 (1.000") +0.27/+0.52 (mm)	73.03 +/-0.38	3.18 +/-0.07	Thrust Washer	W0254-F-073-032-SB
26.990 (1.063") +/-0.13 (mm)	60.33 +/-0.38	1.59 +/-0.07	Thrust Washer	W0269-F-060-016-SB
26.990 (1.063") +/-0.13 (mm)	60.33 +/-0.38	3.18 +/-0.07	Thrust Washer	W0269-F-060-032-SB
28.575 (1.125") +0.13/+0.38 (mm)	47.63 +/-0.38	3.18 +/-0.07	Thrust Washer	W0285-F-048-032-SB
28.575 (1.125") +0.13/+0.38 (mm)	58.74 +/-0.381	3.18 +/-0.064	Thrust Washer	W0285-F-059-032-SB
31.750 (1.250") -0.05/+0.08 (mm)	42.93 +/-0.38	3.18 +/-0.07	Thrust Washer	W0318-F-043-032-SB
31.750 (1.250") +0.13/+0.63 (mm)	50.80 +/-0.38	1.59 +/-0.07	Thrust Washer	W0318-F-051-016-SB
31.750 (1.250") +0.13/+0.63 (mm)	50.80 +/-0.38	3.18 +/-0.07	Thrust Washer	W0318-F-051-032-SB
31.750 (1.250") +0.13/+0.63 (mm)	60.33 +/-0.38	1.59 +/-0.07	Thrust Washer	W0318-F-060-016-SB
31.750 (1.250") +0.13/+0.63 (mm)	60.33 +/-0.38	3.18 +/-0.07	Thrust Washer	W0318-F-060-032-SB
31.750 (1.250") +0.13/+0.63 (mm)	84.13 +/-0.508	1.59 +/-0.07	Thrust Washer	W0318-F-084-016-SB
31.750 (1.250") -0.13/+0.38 (mm)	84.13 +/-0.508	3.18 +/-0.07	Thrust Washer	W0318-F-084-032-SB
35.000 (1.378") -0.08/+0.25 (mm)	49.28 +/-0.38	3.18 +/-0.07	Thrust Washer	W0350-F-049-032-SB

 Stocked or Short Delivery

 Usually Available Short Delivery

 Long delivery or not in current production

* Large Minimum Quantities

** Available only while stock last:

Washers

Nom. ID (d) mm (inches)	OD (D) mm	Thickness (T) mm	Other	Part Number
38.100 (1.500") -0/+0.08 (mm)	50.80 +/-0.38	3.18 +/-0.07	Thrust Washer	W0380-F-051-032-SB
38.100 (1.500") -0/+0.36 (mm)	63.63 +/-0.38	3.18 +/-0.07	Thrust Washer	W0380-F-064-032-SB
38.100 (1.500") +0.03/+0.61 (mm)	88.90 +/-0.508	4.76 +/-0.07	Thrust Washer	W0380-F-089-048-SB
40.000 (1.575") +0.17/+0.34 (mm)	61.91 +/-0.38	3.18 +/-0.07	Thrust Washer	W0400-F-062-032-SB
44.000 (1.732") +0.32/+0.83 (mm)	61.98 +/-0.38	3.18 +/-0.07	Thrust Washer	W0440-F-062-032-SB
44.000 (1.732") +0.58/+1.10 (mm)	66.68 +/-0.38	3.18 +/-0.07	Thrust Washer	W0440-F-067-032-SB
48.000 (1.890") +0.58/+1.61 (mm)	66.68 +/-0.38	3.18 +/-0.07	Thrust Washer	* W0480-F-067-032-SB
50.400 (1.984") +0.03/+0.53 (mm)	76.20 +/-0.38	3.18 +/-0.07	Thrust Washer	W0504-F-076-032-SB
50.400 (1.984") +0.03/+0.53 (mm)	76.20 +/-0.38	4.76 +/-0.07	Thrust Washer	W0504-F-076-048-SB
50.400 (1.984") +0.03/+0.53 (mm)	76.20 +/-0.38	6.35 +/-0.07	Thrust Washer	W0504-F-076-064-SB
50.400 (1.984") +0.53/+1.04 (mm)	92.08 +/-0.508	4.76 +/-0.07	Thrust Washer	W0504-F-092-048-SB
57.150 (2.250") -0.20/+0.30 (mm)	88.90 +/-0.381	3.18 +/-0.064	Thrust Washer	W0572-F-089-032-SB
63.500 (2.500") -0.20/+0.30 (mm)	82.55 +/-0.508	3.18 +/-0.07	Thrust Washer	W0635-F-083-032-SB
70.000 (2.756") -0.20/+0.30 (mm)	98.43 +/-0.508	6.35 +/-0.07	Thrust Washer	W0700-F-098-064-SB

 Stocked or Short Delivery

 Usually Available Short Delivery

 Long delivery or not in current production

* Large Minimum Quantities

** Available only while stock last:

Page 80 of 82

E&OE

TIPS

Sintered bronze bushes are self lubricating until the oil impregnation dries. Sintered bronze bushes should be re-lubricated regularly.

Sintered bronze can usually be identified by it's speckled textured appearance.

Bushes have a relatively high load carrying capacity but a much lower speed capability compared with similar sized ball bearings.

TOLERANCES

A standard toleranced sintered bronze bush is considered to be oversized on both the bore and the outside diameter within the ranges shown below. Many special bushes are also available, falling outside this tolerance range. Please refer to the tolerances shown beneath the size for each specific bush in the catalogue.

Standard tolerance range for ID and OD:

Nominal Size	Tolerance Range
≤ 38.1 mm	+0.025 to +0.051 mm
> 38.1 mm ≤ 63.5 mm	+0.038 to +0.076 mm
> 63.5 mm ≤ 88.9 mm	+0.051 to +0.102 mm
> 88.9 mm ≤ 114.3 mm	+0.064 to +0.127 mm
> 114.3 mm ≤ 139.7 mm	+0.089 to +0.178 mm
> 139.7 mm ≤ 165.1 mm	+0.102 to +0.204 mm

Bushes with non standard tolerances are indicated by a suffix combination of L (Low), H (High), U (Undersized) and T (ID or OD Within Standard Tolerance whilst the other is not). Always refer to the actual tolerances listed below each item in the catalogue.



Distributed By

Miniature Bearings Australia
<http://www.minibearings.com.au>
sales@minibearings.com.au

Resellers: Please place your contact sticker over our details

Avoid verbal communication

We sell an extensive range of products with varying amounts of technical data. Please assist us to provide you with accurate information by placing your orders and enquiries online or by e-mail.

Sintered Bronze