

MBA

Actuator Box - Rack and Pinion - Size 20

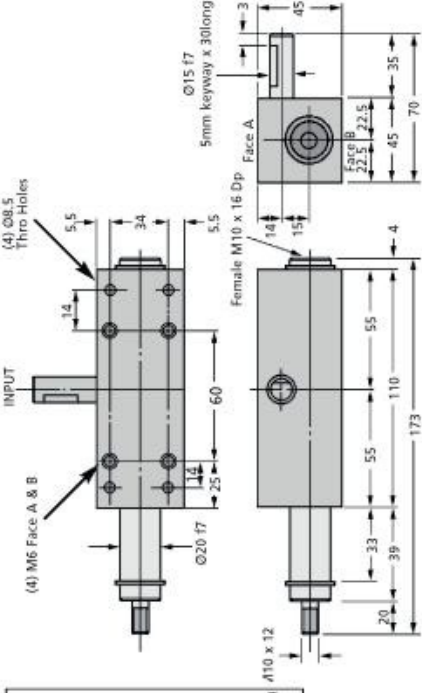
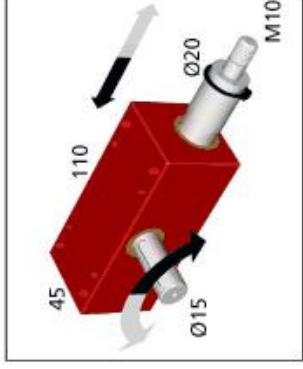

Precision low backlash actuator boxes

Case: AA15 Red Anodised Aluminum (6082-T6)

Rack & Pinion: High Carbon Steel 817M40 (EN24)

Backlash: 2°

Travel: 30mm travel = 196.5° pinion rotation on input : 1mm travel = 6.55° pinion rotation on input

Lubrication: Greased for life - Shell Nerita Grease HV

Actuator Box - Rack and Pinion - Size 20

Part Number	Output Shaft Dia.	Input Shaft Dia	Standard Travel	Max Torque Input @ 100 RPM Nm	Max Load Output Kg	Pinion Module	Angular Movement per mm travel	Total Angular Movement
# RPA20-30	20.0	15.0	30.0	5.20	60.00	1.25	6.55°	195.5°

E&OE Pricing and all details subject to change without notice - Copyright Miniature Bearings Australia Pty Ltd
 MBA Size Listings are a guide to sizes only and must not be solely relied on for critical design information.

MBA **MINIAMNURD**
BEARINGS
 Australia Pty Ltd



ABN 94 069 113 800

DISTRIBUTED BY

Ask us to put your name and address here

<http://www.minibearings.com.au/product>
 Ph +61 7 3349 1224
 Fax +61 7 3349 3801

Catalogue requests to catalogues@minibearings.com.au

